

SHARP®

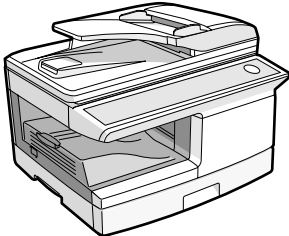

DIGITAL MULTIFUNCTIONAL SYSTEM

OPERATION MANUAL (for general information)



AR-208S/AR-208D

	Page
PREPARATIONS	9
LOADING PAPER	14
MAKING COPIES	20
CONVENIENT COPY FUNCTIONS	26
INSTALLING THE SOFTWARE	36
PRINTER/SCANNER FUNCTIONS	49
USER SETTINGS	54
TROUBLESHOOTING AND MAINTENANCE	61
OPTIONAL EQUIPMENT	80
APPENDIX	82

Each instruction also covers the optional units used with these products.

For users in the USA

FOR YOUR RECORDS ...

To protect against loss theft, record and retain for reference the copier's serial number located on the back of the unit.

Model Number _____

Serial Number _____

Date of Purchase _____

Authorized Sharp Copier _____

Service Department Number _____

NOTICE

BE SURE TO ASK YOUR AUTHORIZED SHARP DEALER ABOUT THE WARRANTY THAT YOUR SELLING DEALER EXTENDS TO YOU. In order to assure you, the end-user, of warranty protection, Sharp extends a limited warranty to each of its authorized dealers and, in turn, requires each of its authorized dealers to extend its own warranty to you on terms that are no less favorable than those given to the dealer by Sharp. You should be aware, however, that Sharp does not itself extend any warranties, either express or implied, directly to you, the end-user, and no one is authorized to make any representations or warranties on behalf of Sharp. Specifically, SHARP DOES NOT EXTEND TO YOU, THE END-USER, ANY EXPRESS WARRANTY OR ANY IMPLIED WARRANTY OF MERCHANTABILITY, FITNESS FOR USE OR FITNESS FOR ANY PARTICULAR PURPOSE IN CONNECTION WITH THE HARDWARE, SOFTWARE OR FIRMWARE EMBODIED IN, OR USED IN CONJUNCTION WITH THIS PRODUCT. Sharp is not responsible for any damages or loss, either direct, incidental or consequential, which you, the end-user, may experience as a result of your purchase or use of the hardware, software or firmware embodied in or used in conjunction with this Product. Your sole remedy, in the event that you encounter any difficulties with this Product, is against the authorized dealer from which you purchased the Product.

AR-208S Digital Multifunctional System

AR-208D Digital Multifunctional System

In the event that this authorized dealer does not honor its warranty commitments, please contact the General Manager, Business Products Group, Sharp Electronics Corporation, Sharp Plaza, Mahwah, New Jersey 07430, so that Sharp can try to help assure complete satisfaction of the warranty rights to which you are entitled from the authorized dealer.

Shielded interface cables must be used with this equipment to maintain compliance with EMC regulations.

Do not make copies of anything which is prohibited from copying by law. The following items are normally prohibited from copying by national law. Other items may be prohibited by local law.

- Money
- Stamps
- Bonds
- Stocks
- Bank drafts
- Checks
- Passports
- Driver's licenses

CONTENTS

CAUTIONS	3
SOFTWARE LICENSE	4
ENVIRONMENTAL INFORMATION	4
INTRODUCTION	6
MAIN FEATURES	7

1 PREPARATIONS

PART NAMES	9
POWER ON AND OFF	12

2 LOADING PAPER

PAPER	14
LOADING THE PAPER TRAY	15
BYPASS FEED (including special paper)	17
CHANGING A TRAY'S PAPER SIZE SETTING	19

3 MAKING COPIES

NORMAL COPYING	20
SELECTING THE TRAY	23
MAKING A COPY DARKER OR LIGHTER	24
REDUCTION/ENLARGEMENT/ZOOM	25

4 CONVENIENT COPY FUNCTIONS

AUTOMATIC TWO-SIDED COPYING	26
SORT COPY	29
COPYING MULTIPLE ORIGINALS ONTO A SINGLE SHEET OF PAPER (2 IN 1 copy)	31
CREATING MARGINS WHEN COPYING (Margin shift)	34

5 INSTALLING THE SOFTWARE

SOFTWARE	36
BEFORE INSTALLATION	37
INSTALLING THE SOFTWARE	38
SETTING UP BUTTON MANAGER	45

6 PRINTER/SCANNER FUNCTIONS

USING THE PRINTER MODE	50
BASIC PROCEDURE FOR PRINTING	50
USING THE SCANNER MODE.....	51
SCANNING USING THE KEYS ON THE MACHINE	51
SCANNING FROM YOUR COMPUTER	52
OPERATION IN COPY, PRINTER, AND SCANNER MODES	52
HOW TO USE THE ONLINE MANUAL	53

7 USER SETTINGS

USER PROGRAMS.....	54
SELECTING A SETTING FOR A USER PROGRAM.....	59

8 TROUBLESHOOTING AND MAINTENANCE

DISPLAY MESSAGES.....	61
TROUBLESHOOTING THE MACHINE	63
PROBLEMS DURING SETUP OF THE SOFTWARE	67
MISFEED REMOVAL	70
TONER CARTRIDGE REPLACEMENT	74
SCAN HEAD LOCKING SWITCH	76
CHECKING THE TOTAL COUNT.....	77
MAINTENANCE REQUIRED	77
CLEANING THE MACHINE	78

9 OPTIONAL EQUIPMENT



SYSTEM CONFIGURATION	80
FACSIMILE EXPANSION KIT (AR-FX13).....	80
NETWORK EXPANSION KIT (AR-NB2 A)	80
250-SHEET PAPER FEED UNIT (AR-D33)	80

10 APPENDIX

SPECIFICATIONS	82
MATERIAL SAFETY DATA SHEET	87
INDEX.....	95

CAUTIONS

Caution label on the machine

The label ( ) in the fusing area of the machine indicates the following:

 : Caution, risk of danger

 : Caution, hot surface

Cautions on using the machine

Follow the cautions below when using this machine.

Warning:

- The fusing area is hot. Exercise care in this area when removing misfed paper.
- Do not look directly at the light source. Doing so may damage your eyes.

Caution:

- Place the machine on a firm, level surface.
- Do not install the machine in a humid or dusty location.
- When the machine is not used for a long time, for example during prolonged holidays, turn the power switch off and remove the power cord from the outlet.
- When moving the machine, be sure to turn the power switch off and remove the power cord from the outlet.
- Do not switch the machine rapidly on and off. After turning the machine off, wait 10 to 15 seconds before turning it back on.
- Do not cover the machine with a dust cover, cloth or plastic film while the power is on. Doing so may prevent heat radiation, damaging the machine.
- Use of controls or adjustments or performance of procedures other than those specified herein may result in hazardous radiation exposure.
- The socket-outlet shall be installed near the machine and shall be easily accessible.

Important points when selecting an installation site

Do not install your machine in areas that are:

- damp, humid, or very dusty
- exposed to direct sunlight
- poorly ventilated
- subject to extreme temperature or humidity changes, e.g., near an air conditioner or heater.

Be sure to allow the required space around the machine for servicing and proper ventilation.

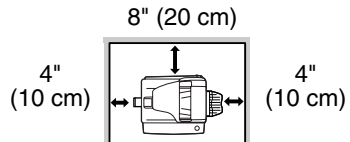

Cautions on handling the machine

Be careful in handling the machine as follows to maintain the performance of this machine.

Do not drop the machine, subject it to shock or strike it against any object.

Store spare toner cartridges in a cool dry place without removing from the package before use.

- If they are exposed to direct sunlight or excessive heat, poor copies may result.

Do not touch the photoconductive drum (green portion).

- Scratches or smudges on the drum will cause dirty copies.

Trademark acknowledgements

- Microsoft®, Windows®, Windows® 98, Windows® Me, Windows® 2000, Windows® XP, Windows Vista® and Internet Explorer® are registered trademarks or trademarks of Microsoft Corporation in the U.S.A. and other countries.
- Macintosh is a trademark of Apple Inc., registered in the U.S. and other countries.
- IBM, PC/AT, and PowerPC are trademarks of International Business Machines Corporation.
- Adobe, the Adobe logo, Acrobat, the Adobe PDF logo, and Reader are registered trademarks or trademarks of Adobe Systems Incorporated in the United States and other countries.
- All other trademarks and copyrights are the property of their respective owners.

SOFTWARE LICENSE

The SOFTWARE LICENSE will appear when you install the software from the CD-ROM. By using all or any portion of the software on the CD-ROM or in the machine, you are agreeing to be bound by the terms of the SOFTWARE LICENSE.

ENVIRONMENTAL INFORMATION

For users in the USA



Products that have earned the ENERGY STAR® are designed to protect the environment through superior energy efficiency.

Laser information

Wave length	780 nm +15 nm -10 nm
Pulse times (North America)	12.88 μ s \pm 12.88 ns/7 mm
Output power	Max 0.2 mW

At the production line, the output power of the scanner unit is adjusted to 0.18 MILLIWATT PLUS 5% and is maintained constant by the operation of the Automatic Power Control (APC).

Caution

Use of controls or adjustments or performance of procedures other than those specified herein may result in hazardous radiation exposure.

This Digital Equipment is CLASS 1 LASER PRODUCT (IEC 60825-1 Edition 1.2-2001)

SAFETY PRECAUTIONS

This Digital Copier is rated Class 1 and complies with 21 CFR 1040.10 and 1040.11 of the CDRH standards. This means that the equipment does not produce hazardous laser radiation. For your safety, observe the precautions below.

- Do not remove the cabinet, operation panel or any other covers.
- The equipment's exterior covers contain several safety interlock switches. Do not bypass any safety interlock by inserting wedges or other items into switch slots.

A small amount of ozone is produced within the unit during operation. The emission level is insufficient to cause any health hazard.

Note:

The present recommended long term exposure limit for ozone is 0.1ppm (0.2mg/m³) calculated as an 8 hr. time-weighted average concentration.

However, since the small amount that is emitted may have an objectionable odor, it is advisable to place the unit in a ventilated area.

For users in Canada

The Environmental Choice Program guidelines are applied to the products only in Canada. The products that meet the Environmental Choice Program guidelines carry the logo shown to the left. The products without the logo may not meet the Environmental Choice Program guidelines.

INTRODUCTION



Some model may not be available in some countries.

Using the manual

This machine has been designed to provide convenient copying features in a minimum amount of office space and with maximum operational ease. To get full use of all machine features, be sure to familiarize yourself with this manual and the machine. For quick reference during machine use, keep this manual in a handy location.

About the operation manuals

The operation manuals for the machine are as follows:

Operation Manual (this manual)

Explains the machine and how to use it as a copier. Also explains how to install the software that allows the machine to be used as a printer and scanner for your computer.

Online Manual (on the accessory CD-ROM)

This manual explains the procedures for using the machine as a printer or a scanner.

Conventions used in this manual and online manual

- The illustrations in this manual show the AR-208D. The appearance of your machine may be different depending on the model and options installed, however, the basic operations are the same.
- Where "AR-XXXX" appears in this manual, please substitute the name of your model for "XXXX". For the name of your model, see the operation panel on the machine.
- Illustrations of driver screens and other computer screens show the screens that appear in Windows XP Home Edition. Some of the names that appear in these illustrations may differ slightly from the screens that appear in other operating systems.
- The explanations in this manual assume that the person who will install the product and the users of the product have a working knowledge of Microsoft Windows.
- This operation manual refers to the Reversing Single Pass Feeder as the "RSPF".
- In this manual, the following icons are used to provide the user with information pertinent to the use of the machine.



Warns that injury may result if the contents of the warning are not properly followed.



Cautions that damage to the machine or one of its components may result if the contents of the caution are not properly followed.



Notes provide useful information on the specifications, functions, performance, and operation of the machine.

The display screens, messages, and key names shown in the manual may differ from those on the actual machine due to product improvements and modifications.

MAIN FEATURES

High-speed laser copying

First-copy time*¹ is only 8.0*² seconds.

Copying speed is 20 copies per minute. This is ideal for business use and provides a big boost to workplace productivity.

*¹ The first-copy time is measured after the power save indicator turns off following power on, using the document glass with the polygon rotating in the copy ready state and "LSU SETTING" set to ON in the user programs (8-1/2" x 11", paper fed from paper tray).

*² When user program 24 is set to OFF.

High-quality digital image

- High-quality copying at 600 dpi is performed.
- In addition to automatic exposure adjustment, two original modes can be selected: "TEXT" for text-only originals, and "PHOTO" for photographs. The exposure can be adjusted to five levels in each mode.
- The photo mode copying function allows clear copying of delicate halftone original images such as monochrome photos and color photos.

Enhanced copying features

- Zoom copies can be made from 25% to 400% in increments of 1%. (When the RSPF is being used, the zoom copy ratio range is 50% to 200%.)
- Continuous copying of up to 99 copies is possible.
- Sets of output can be offset from each other for easy separation (offset function).
- Sorting by sets is possible without the need for a sorter or other special device (Sort copy).
- Includes convenient features such as margin shift, 2 IN 1 copy, and automatic two-sided copying.

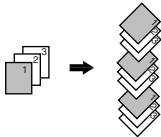

Sort copy

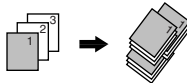

Offset function



2 IN 1 copy



Margin shift

Scan once/Print many

- The machine is equipped with a memory buffer allowing the machine to scan an original once and make up to 99 copies of the scanned image. This improves workflow, reduces operating noise from the machine and reduces wear and tear on the scanning mechanism, which provides for a higher reliability.

LCD panel displays messages

- The LCD panel displays messages that show function settings and the status of the machine.

Laser printer function

- The accompanying printer driver can be installed to enable use of the machine as a printer.

Color scanner function

- The accompanying scanner driver can be installed and the machine connected to a computer using a USB cable to enable use as a scanner.

Fax function (option)

- The optional Facsimile Expansion Kit can be installed to enable the machine to be used as a fax machine. (Facsimile Expansion Kit Operation Manual)

Network connection (option)

- The optional Network Expansion Kit can be installed to enable the machine to be used as a network printer and network scanner. (Network Expansion Kit Operation Manual)

Environment and people friendly design

- Preheat mode and auto power shut-off mode are provided to reduce power consumption when the machine is not in use.
- A universal design has been implemented in the product whereby the height of the operation panel and shape of the keys are designed to be usable by as many people as possible.

This chapter provides basic information that you should know before using the machine.

PART NAMES

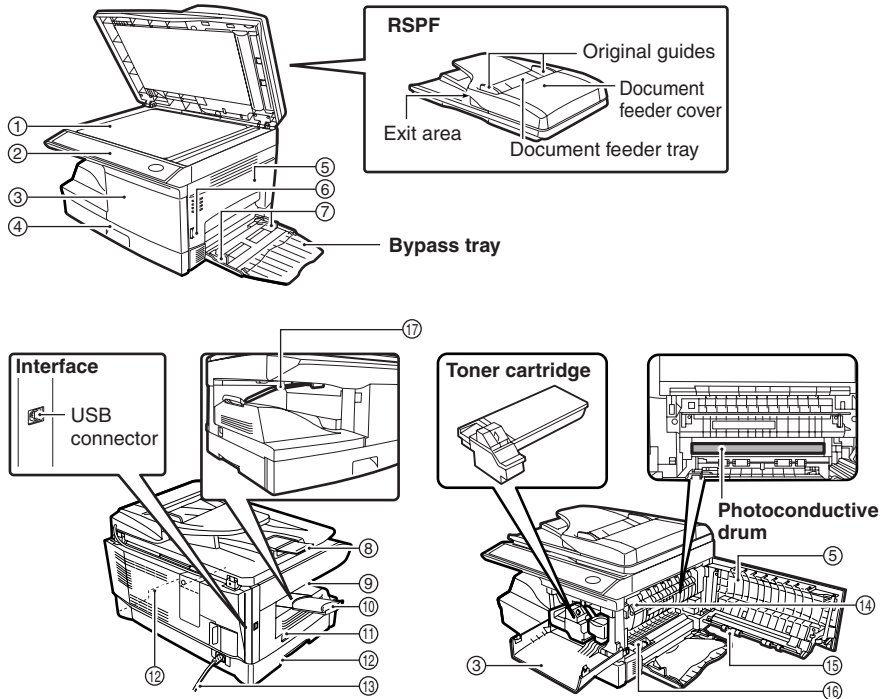

- | | |
|----------------------------------|-------------------------------|
| ① Document glass | ⑩ Paper output tray extension |
| ② Operation panel | ⑪ Power switch |
| ③ Front cover | ⑫ Handles |
| ④ Paper tray | ⑬ Power cord |
| ⑤ Side cover | ⑭ Fusing unit release lever |
| ⑥ Side cover open button | ⑮ Transfer charger |
| ⑦ Bypass tray paper guides | ⑯ Charger cleaner |
| ⑧ Original output tray extension | ⑰ Paper holder arm |
| ⑨ Paper output tray | |

Operation panel

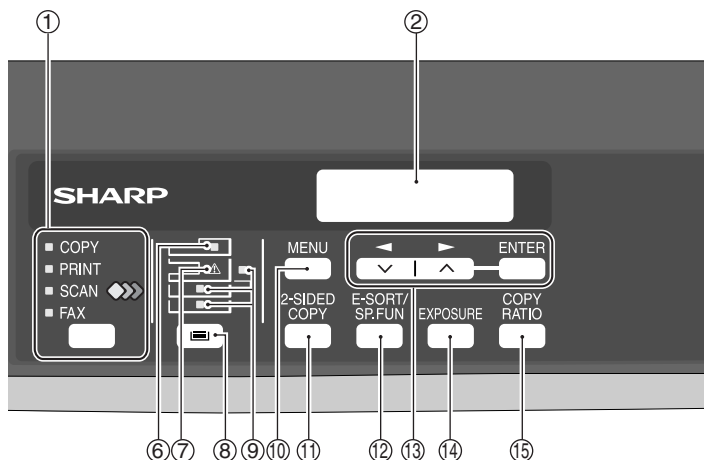
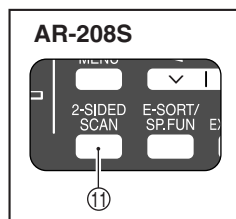

- ① **[MODE SELECT] key / Mode indicators**
 Press this key to select the mode. The indicator of the selected mode lights (copy, printer, scanner, fax mode indicators).
- ② **Display**
 This shows messages indicating the machine status and any problems that occur, as well as user programs and function setting menus.
- ③ **Numeric keys**
 Use these to enter the number of copies and other numerical settings. The keys can also be used to select items in function setting menus.
- ④ **[CLEAR] key (C)**
 Use this to clear the set number of copies, as well as cancel a job that is in progress. When a setting menu appears, use this key to move back to the previous menu level.
- ⑤ **Power save indicator**
 This lights up when the power save function is activated.
- ⑥ **RSPF indicator**
 This lights up when an original is placed in the RSPF.
- ⑦ **Error indicator**
 This lights steadily or blinks when a paper misfeed or other error occurs.
- ⑧ **[TRAY SELECT] key ()**
 Use to select the paper tray that has the desired paper for copying.
- ⑨ **Tray location indicator**
 Indicates the selected paper tray. The indicator blinks when the tray is out of paper during operation or is not closed properly.
- ⑩ **[MENU] key**
 Press this key to select the paper size for copying, to configure a user program or to display the total count.
- ⑪ **[2-SIDED COPY] key (AR-208D)**
[2-SIDED SCAN] key (AR-208S)
 Press in copy mode to select one-sided or two-sided settings for the original and for the output.
- ⑫ **[E-SORT/SP.FUN] key**
 Press to select the sort function, 2 IN 1 copy function, or margin shift function.
- ⑬ **[◀] key (), [▶] key (), [ENTER] key**
 Press the [◀] key () or [▶] key () to select an item in a function setting menu. Press the [ENTER] key to enter a selection.
- ⑭ **[EXPOSURE] key**
 Use to switch from auto exposure adjustment to text mode or photo mode.

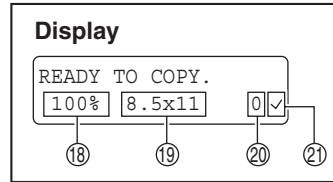
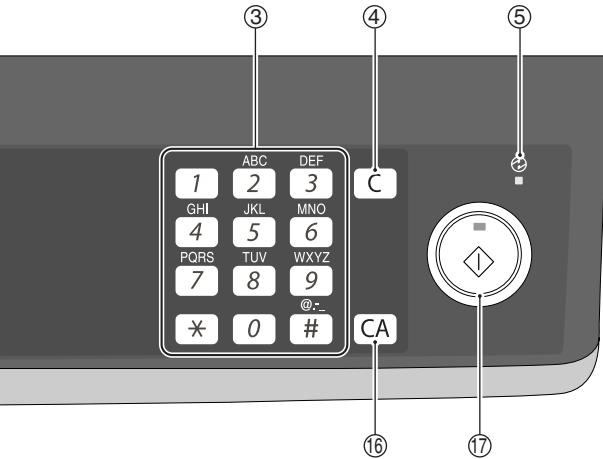

15 [COPY RATIO] key

Press to select an enlargement or reduction ratio.

To select a preset ratio setting, press the [COPY RATIO] key and select the desired preset ratio. To select a ratio that is not preset, press the [COPY RATIO] key, select the preset ratio that is closest to the desired ratio, and then press the [◀] key (◁) or [▶] key (▷) to increase or decrease the ratio in increments of 1%.

16 [CLEAR ALL] key (CA)

This returns all functions to the default settings. When pressed in a setting menu, this returns the settings and display to the initial state.

17 [START] key (⏻) / Ready indicator

The ready indicator lights up when copying or scanning is possible.

To begin copying, press the [START] key (⏻).

The [START] key (⏻) is also pressed to return to normal operation from auto power shut-off mode.

18 Shows the current copy ratio.

19 Shows the selected paper size.

20 Shows the number of copies that has been entered with the numeric keys.

21 A checkmark "✓" appears when the exposure has been changed, or when two-sided copying, sort, 2 IN 1, or margin shift is selected.

POWER ON AND OFF

The power switch is located on the left side of the machine.



If you use the machine in a country other than the country where the machine was purchased, you will need to make sure that your local power supply is compatible with your model. If you plug the machine into an incompatible power supply, irreparable damage to the machine will result.

Power on

Turn the power switch to the "ON" position.

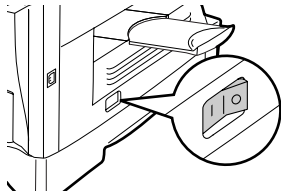

The ready indicator will light up and other indicators which show the initial settings of the display will also light up to indicate the ready condition. For the initial settings, see "Initial settings" (below).

You can select copy settings and press the [START] key (⊙) after the power switch is turned on. Copying will start automatically.



Only insert the power cord into a properly grounded wall socket. Do not use extension cords or power strips.

Language setting

The first time the power is turned on after shipment from the factory, a message will appear in English in the display prompting you to select the language. Select the language with the [◀] key (◀) or [▶] key (▶) and then press the [ENTER] key. The language can also be changed in the user programs (p.57).

Initial settings

The machine reverts to the initial settings when it is first turned on, when the [CLEAR ALL] key (CA) is pressed, or when no keys are pressed for the preset "AUTO CLEAR" time following the end of a copy job. When the machine reverts to the initial settings, all settings and functions selected to that point are canceled. The "AUTO CLEAR" can be changed in the user programs. (p.54)

When in the copy mode

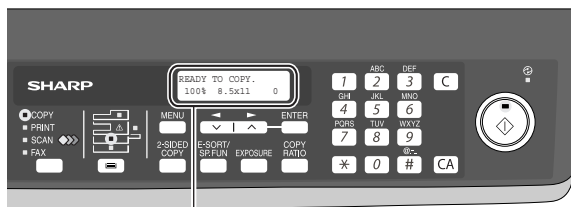

The main screen of copy mode appears.

Copy ratio: 100%, Exposure: Automatic
Copy quantity: 0, All special copier modes: Off

Scanning unit (scan head)

When the machine is able to copy or scan (the ready indicator is on), the scanning unit is lit.

Power off

Make sure that the machine is not in operation and then turn the power switch to the "OFF" position.

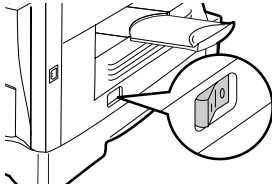

If the power switch is turned off while the machine is in operation, a misfeed may occur and the job that was in progress will be canceled.

In cases where the machine will not be used for a long time, turn off the power switch and remove the power cord from the outlet.

Check the following to make sure the machine is not in operation:

- The ready indicator is lit. (Initial state)
- The power save indicator is lit. (preheat mode or auto power shut-off mode)

Power save modes

The machine has two power save modes to reduce overall power consumption and thereby reduce the cost of operation. In addition, these modes conserve natural resources and help reduce environmental pollution. The two power save modes are preheat mode and auto power shut-off mode.

Preheat mode

This function automatically switches the machine to a low power consumption state if the set duration of time elapses without the machine being used when the power is on. In this mode, the power save indicator lights up. Normal operation automatically resumes when a key on the operation panel is pressed, an original is placed, a print job is received.

Auto power shut-off mode

This function automatically switches the machine to a state that consumes even less power than preheat mode if the set duration of time elapses without the machine being used when the power is on. The power save indicator lights up, the display shows a message indicating that the machine is in auto power shut-off mode. To resume normal operation, press the [START] key (⏻). Normal operation also resumes automatically when a print job is received or scanning is begun from a computer. While in auto power shut-off mode, no keys (except the [START] key (⏻)) can be used.



The preheat activation time and the auto power shut-off time can be changed with "PREHEAT MODE" and "AUTO SHUT-OFF TIME" in the user programs. It is suggested that you set times that are appropriate for your usage of the machine. (p.54 and p.55)

Check RSPF open function

When enabled, this function may help prevent wasteful use of toner that occurs when the RSPF cover is not completely closed.

If the start (⏻) key is pressed when the RSPF cover is not completely closed, "CLOSE THE SPF/RSPF COVER." will appear in the display and copying may not take place. If copying does not take place, copying can be performed by pressing the start (⏻) key again, however, the scan size set in "TRAY'S PAPER SIZE SETTING" (p.19) or "VALID COPY WIDTH" (program number 25) (p.57) will be used.

If the RSPF cover is completely closed after "CLOSE THE SPF/RSPF COVER." appears, copying will take place at the normal size.

The tray location indicator will blink when there is no paper in the selected paper tray, or when the selected paper tray is not closed or is improperly closed.

PAPER

For best results, use only SHARP recommended paper.

Paper tray type	Paper type	Size	Weight	Capacity
Paper tray	Standard paper Recycled paper	5-1/2" x 8-1/2" (Invoice) 8-1/2" x 11" (Letter) 8-1/2" x 13" (Foolscap) 8-1/2" x 14" (Legal)	15 lbs. to 21 lbs. (56 g/m ² to 80 g/m ²)	250 sheets * ¹ (The paper should not exceed the line on the tray)
Bypass tray	Standard paper Recycled paper	3-1/2" x 5-1/2" to 8-1/2" x 14"	15 lbs. to 21 lbs. (56 g/m ² to 80 g/m ²)	50 sheets * ¹
	Thick paper		15 lbs. to 34.5 lbs. (56 g/m ² to 128 g/m ²)* ³	
	Transparency film/Labels	Envelopes * ²		Monarch (3-7/8" x 7-1/2") Commercial 9 (3-7/8" x 8-7/8") Commercial 10 (4-1/8" x 9-1/2")

*¹ The number of sheets of paper that can be loaded varies depending on the weight of the paper.

*² Do not use non-standard envelopes or envelopes that have metal clasps, plastic snappers, strings, windows, linings, self-adhesive strips, patches or synthetic materials. Do not use envelopes that are filled with air or envelopes that have labels or stamps attached. These will damage the machine.

*³ When using paper heavier than 28 lbs. (104 g/m²), use paper that is 8-1/2" x 11" or smaller.

Special papers

Follow these guidelines when using special papers.

- Use SHARP recommended transparency film and label sheets. Using other than SHARP recommended paper may result in misfeeds or smudges on the output. If other than SHARP recommended media must be used, feed each sheet one at a time using the bypass tray (do not attempt continuous copying or printing).
- There are many varieties of special paper available on the market, and some cannot be used with this machine. Before using special paper, contact a SHARP service center.
- Before using other than SHARP recommended paper, make a test copy to see if the paper is suitable.

LOADING THE PAPER TRAY



Make sure that the paper is not torn, is free of dust, and has no wrinkles or curled edges.

- 1** Raise the handle of the paper tray and pull the paper tray out until it stops.

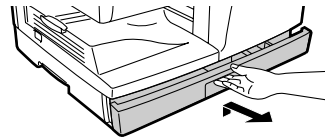

- 2** Fan the paper and insert it into the tray. Make sure that the edges go under the corner hooks.



- Do not load paper above the maximum height line (). Exceeding the line will cause a paper misfeed.
- If the paper is not fanned, double-feeds or misfeeds may occur.
- Make sure the stack of paper is straight before loading it. When adding paper, take the remaining paper out and combine it into a single stack with the new paper.
- Make sure that all the paper in the stack is the same size and type.
- When loading paper, ensure that there is no space between the paper and the guide, and make sure that the guide is not set too narrow and causes the paper to bend. Incorrect loading will cause the paper to skew or misfeed.

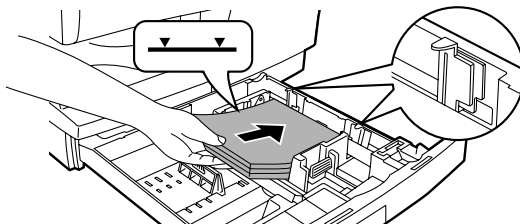

3 Gently push the paper tray back into the machine.



- If you loaded a paper size that is different from the previously loaded paper size, change the paper size setting as explained in "CHANGING A TRAY'S PAPER SIZE SETTING" (p.19)
- When not using the machine for an extended period, remove all paper from the paper tray and store it in a dry place. If paper is left in the machine for an extended period, the paper will absorb moisture from the air, resulting in paper jams.

BYPASS FEED (including special paper)

The bypass tray can be used to feed standard paper, transparency film, labels, envelopes, and other special purpose paper.

Important points when inserting paper in the bypass tray

Up to 50 sheets of standard copy paper can be inserted in the bypass tray. (Capacity will vary depending on the type of paper loaded.)

Be sure to place envelopes horizontally as shown in the following diagram.

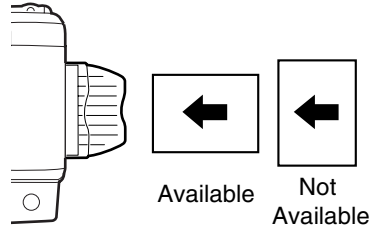

- When loading envelopes, make sure that they are straight and flat and do not have loosely glued construction flaps (not the closure flap).
- Special papers such as SHARP recommended transparency film, labels, and envelopes must be fed one sheet at a time through the bypass tray.
- When adding paper, first remove any paper remaining in the tray, combine it with the paper to be added and then reload as a single stack. The paper to be added must be the same size and type as the paper already in the tray.
- Do not use paper that is smaller than the original. This may cause smudges or unclear images.
- Do not use paper that has already been printed on by a laser printer or plain paper fax machine. This may cause smudges or unclear images.

Envelopes

Do not use the following envelopes, as misfeeds will occur.

- Envelopes with metal tabs, clasps, strings, holes, or windows.
- Envelopes with rough fibers, carbon paper, or glossy surfaces.
- Envelopes with two or more flaps.
- Envelopes with tape, film, or paper attached to the flap.
- Envelopes with a fold in the flap.
- Envelopes with glue on the flap to be moistened for sealing.
- Envelopes with labels or stamps.
- Envelopes that are slightly inflated with air.
- Envelopes with glue protruding from the seal area.
- Envelopes with part of the seal area peeled off.
- Be sure to select com9, com10 or Monarch in the paper size setting of the printer driver. (For detailed information on the printer driver, refer to the online manual.)

Loading paper in the bypass tray



- Paper must be fed narrow side first into the feed slot.
- Special papers such as transparency film, labels, and envelopes must be fed one sheet at a time through the bypass tray.
- When copying onto transparency film, remove each copy promptly. Do not let copies stack up.

1 Open the bypass tray and extend the tray.

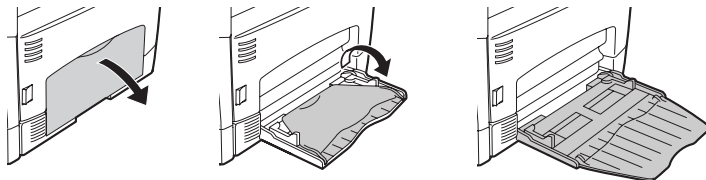

To close the bypass tray, perform step ① and then step ② in the illustration and push the round projections at the right of the tray until they click.

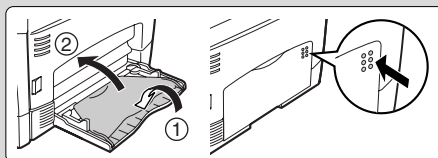

2 Set the bypass tray paper guides to the paper width. Insert the paper (print face down) all the way into the bypass tray.

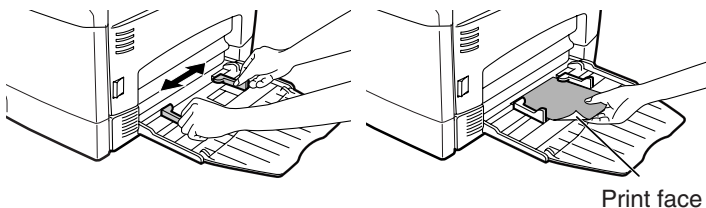

3 Press the [TRAY SELECT] key () to select the bypass tray.

Note for loading thick paper

Copying on thick paper requires higher fusing temperature setting. Set the user program 29 to "2 (HEAVY PAPER)" when using thick paper. (See page 57.)

CHANGING A TRAY'S PAPER SIZE SETTING

Follow these steps to change a tray's paper size setting.



- The paper size setting cannot be changed when the machine has stopped temporarily due to running out of paper or a misfeed.
- During printing (even in copy mode), the paper size setting cannot be changed.

1 Press the [MENU] key.
Press the [◀] key (▼) or [▶] key (▲) until "PAPER SIZE" appears, and then press the [ENTER] key.

2 Press the [◀] key (▼) or [▶] key (▲) to select the tray, and then press the [ENTER] key.

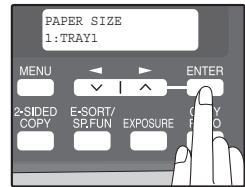

3 Press the [◀] key (▼) or [▶] key (▲) to select the paper size, and then press the [ENTER] key.

The paper size changes as follows each time the [◀] key (▼) or [▶] key (▲) is pressed:
"8.5x14" → "8.5x13" → "8.5x11" → "5.5x8.5"
→ "A4" → "B5" → "A5".

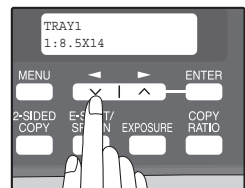

When you have finished configuring the tray's paper size setting, press the [MENU] key.

4 Squeeze the lock lever of the front guide and slide the front guide to match the width of the paper, and move the left guide to the appropriate slot as marked on the tray.

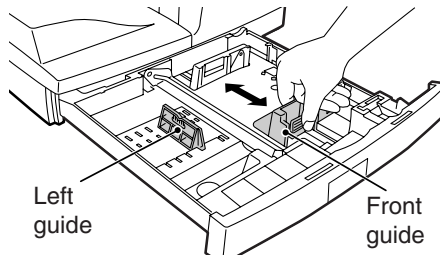

- The front guide is a slide-type guide. Grasp the locking knob on the guide and slide the guide to the indicator line of the paper to be loaded.
- The left guide is an insert-type guide. Remove it and then insert it at the indicator line of the paper to be loaded.

This chapter explains basic copying functions.

NORMAL COPYING

Using the document glass



Note

- The document glass can scan up to 8-1/2" x 14" original.
- When a copy is made, the edges will not be copied (image loss). For the image loss, see the "SPECIFICATIONS" (p.82).

- 1 Open the RSPF, and place the original face down on the document glass.**

[How to place the original]

Align the original with the original scale and the centering (▶) mark.

Original scale

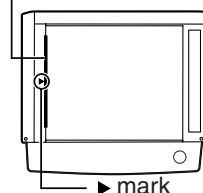

- 2 Gently close the RSPF.**

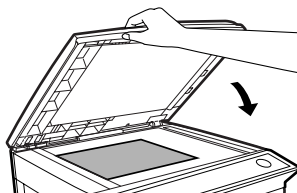

- 3 Select the number of copies and any other copy settings, and then press the [START] key (⊙).**



Note

- To stop copying in the middle of a run, press the [CLEAR] key (⊞).
- For the copy settings, see pages 23 through 35.

Copying books or originals with folds or creases

Press down on the RSPF while copying as shown. If the RSPF is not completely closed, shadows may appear on the copy or it may be fuzzy. Straighten originals that have folds or creases before placing it on the document glass.

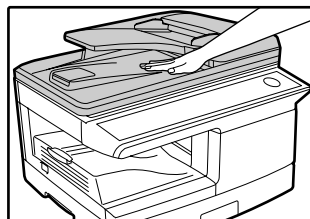

Using the RSPF



- Originals that are 5-1/2" x 8-1/2" to 8-1/2" x 14" and 14 lbs. to 24 lbs. (56 g/m² to 90 g/m²) can be used. A maximum of 50 pages can be placed at once.
- Straighten curled originals before placing them in the document feeder tray. Curled originals may cause misfeeds.
- Place originals horizontally.
- Before placing originals in the document feeder tray, be sure to remove any staples or paper clips from them.
- When a copy is made, the edges will not be copied (image loss). For the image loss, see the "SPECIFICATIONS" (p.82).
- When using the margin shift function, check the position of the margins carefully. (p.34)

1 Make sure that an original has not been left on the document glass.

2 Adjust the original guides to the size of the originals.

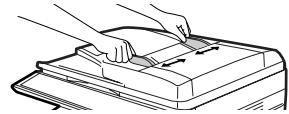

3 Place the original(s) face up in the document feeder tray without trying to force them in.

The RSPF indicator on the operation panel will light up. If this indicator does not light up, the originals are not properly set or the RSPF is not properly closed.

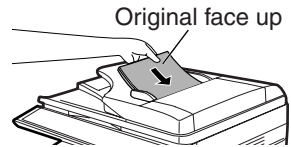

4 Select the number of copies and any other copy settings, and then press the [START] key (⊙).



- The default output mode for copying from the RSPF is sort mode (P.29), and a checkmark "✓" will automatically appear in the display (P.11). If "SORT AUTO SELECT" is disabled in the user programs, the default output mode will be non-sort mode. (P.57)
- To stop copying in the middle of a run, press the [CLEAR] key (⊞).
- For the copy settings, see pages 23 through 35.

MAKING COPIES

Originals that cannot be used in the RSPF

The following originals cannot be used. These may cause misfeeds or smudging and unclear images.

- Transparencies, tracing paper, other transparent or translucent paper, and photographs.
- Carbon paper, thermal paper.
- Originals that are creased, folded, or torn.
- Glued originals, cut-out originals.
- Originals with binder holes.
- Originals printed using an ink ribbon (thermal transfer printing), originals on thermal transfer paper.

Original output tray extension

When placing an original larger than 8-1/2" x 11" size, pull out the original output tray extension of the RSPF.

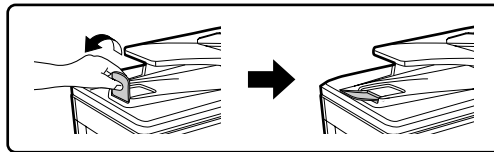

Capacity of paper output tray

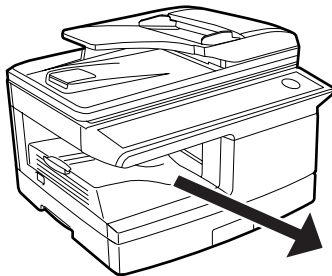

The paper output tray can hold a maximum of 200 pages. If more than 200 pages are allowed to accumulate, a paper jam may occur.

Paper output tray extension

When copying onto paper larger than 8-1/2" x 11" size, pull out the paper output tray extension.

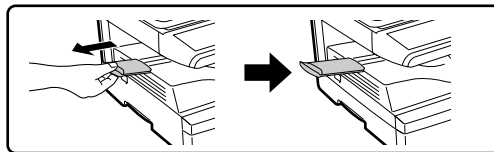

Paper holder arm

The paper output tray has a paper holder arm. The paper holder arm presses gently on the output paper to stack it (p.9).



After removing paper, if you need to return the paper to the paper output tray, lift up the paper holder arm and place the paper under the arm.

Setting the number of copies

Press the numeric keys to set the number of copies.

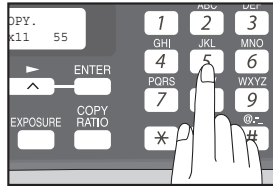

- The set number of copies appears in the display. A maximum of 99 copies can be set.
- If you wish to make only a single copy, copying is possible with the display showing "0".



If you enter the wrong number, press the [CLEAR] key (C) and enter the correct number.

SELECTING THE TRAY

Press the [TRAY SELECT] key (TRAY).

Each time, you press the [TRAY SELECT] key (TRAY), the location indicated by the tray location indicator changes in the following order : paper tray → lower paper tray (when the 250-sheet paper feed unit is installed.) → bypass tray.

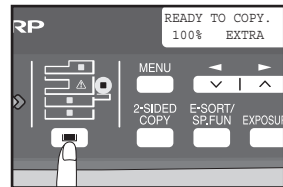

The tray location indicator will blink when there is no paper in the paper tray during operations, or when the tray is not closed or is improperly closed.

MAKING A COPY DARKER OR LIGHTER

Automatic exposure adjustment is initially enabled. This function automatically adjusts the copy image according to the original being copied. If you wish to select the exposure level yourself, follow the steps below. (Select from 2 original types and 5 exposure levels for each original type.) The exposure level used in automatic exposure adjustment can also be changed with "AE LEVEL ADJUST" in the user programs (p.57).

Original types

- AUTO Automatic exposure adjustment is enabled and the exposure is automatically adjusted according to the original being copied. The exposure is lowered for colored areas and background shadows.
- TEXT The exposure is raised for light areas and lowered for dark backgrounds to make text easier to read.
- PHOTO ... Halftones in the photo are reproduced with greater clarity.

1 Place the original(s).

2 Press the [EXPOSURE] key to select the original type.

The original image type changes as follows each time the [EXPOSURE] key is pressed: "AUTO" → "TEXT" → "PHOTO".

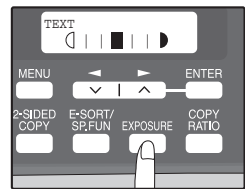

To return to auto exposure adjustment, press the [EXPOSURE] key until "AUTO" appears.

3 If needed, adjust the exposure level for TEXT or PHOTO.

For a darker image, press the [▶] key (◀▶). For a lighter image, press the [◀] key (▶◀).

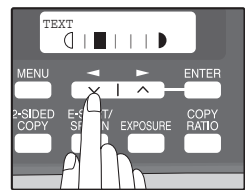

4 Press the [ENTER] key.

5 Select the number of copies and any other copy settings, and then press the [START] key (⊙).



Exposure value guidelines (When in "TEXT" setting)



- Colored text or text written in pencil
- Normal originals
- Dark originals like newspapers

REDUCTION/ENLARGEMENT/ZOOM

Copies can be reduced down to 25% or enlarged up to 400%. (When the RSPF is being used, the zoom copy ratio range is 50% to 200%.) The [COPY RATIO] key can be pressed to quickly select a ratio from among eight preset ratios. In addition, the [◀] key (▽) and [▶] key (△) can be pressed to select the ratio in increments of 1%.

1 Place the original(s) and check the paper size.

2 Press the [COPY RATIO] key.

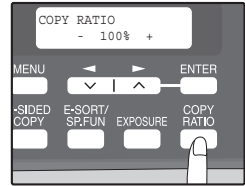

3 Press the [COPY RATIO] key and/or [◀] key (▽) or [▶] key (△) to select the desired copy ratio and then press the [ENTER] key.

Selecting a preset ratio

The preset ratios change as follows each time the [COPY RATIO] key is pressed:

"100%" → "78%" → "64%" → "50%" → "25%" →

"400%" → "200%" → "129%"

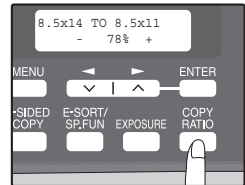

Fine adjustment of the ratio

The ratio can be adjusted from 25% to 400% in increments of 1%.

Use the [◀] key (▽) or the [▶] key (△) for fine adjustment.

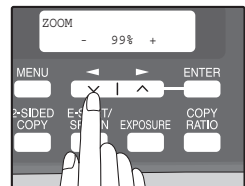



- To return the ratio to 100%, press the [COPY RATIO] key until 100% appears.
- Press the [COPY RATIO] key to set the approximate ratio, then press the [◀] key (▽) or [▶] key (△).
- To decrease or increase the zoom ratio rapidly, hold down the [◀] key (▽) or [▶] key (△).
The ratio will stop changing at each of the preset ratios. To continue changing the ratio, release the key and then hold it down again.

4 Select the number of copies and any other copy settings, and then press the [START] key (⊙).

The copy will be delivered to the paper output tray.

AUTOMATIC TWO-SIDED COPYING

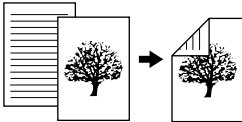
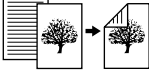
Two originals can be automatically copied onto both sides of a single sheet of paper. When the RSPF is used, two-sided copies of two-sided originals can easily be made. (On the AR-208S, only two-sided original → one sided copy is possible.)

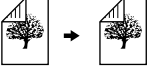
	Original → Paper			Usable paper
Document glass	One-sided original → Two sides* 			5-1/2" x 8-1/2", 8-1/2" x 11", 8-1/2" x 13", 8-1/2" x 14" • The bypass tray cannot be used.
RSPF	One-sided original → Two sides* 	Two-sided original → One side 	Two-sided original → Two sides* 	5-1/2" x 8-1/2", 8-1/2" x 11", 8-1/2" x 13", 8-1/2" x 14" • Special paper cannot be used. • The bypass tray can only be used when making one-sided copies from two-sided originals.

* AR-208D only

When performing automatic two-sided copying of one-sided originals, the orientation of the copied image can be selected according to the binding position of the paper.

SHORT EDGE: Select when binding the paper at the short edge.



(Paper orientation: Landscape) (Paper orientation: Portrait)

LONG EDGE: Select when binding the paper at the long edge.



(Paper orientation: Landscape) (Paper orientation: Portrait)

Using the document glass (AR-208D only)

1 Place the original that you wish to copy onto the front side of the paper on the document glass and close the RSPF.

2 Press the [2-SIDED COPY] key until "1 TO 2" appears, and then press the [ENTER] key.

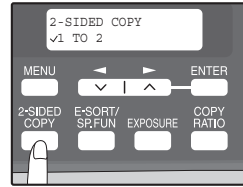

3 Press the [◀] key (◁) or [▶] key (▷) to select the binding edge and then press the [ENTER] key.

Select "LONG EDGE" or "SHORT EDGE". The "LONG EDGE" and "SHORT EDGE" are shown in the illustration on the preceding page.

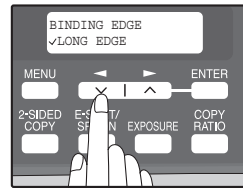

4 Select the number of copies and any other settings, and then press the [START] key (⊙).

"[START] : NEXT SCAN [#] : START PRINT" appears and the original is scanned into memory.

To immediately print the scanned image, press the [#] key.

5 Replace the original with the next original and close the RSPF, and then press the [START] key (⊙).

Repeat step 5 until all originals have been scanned.

Copies will be output each time two originals have been scanned.

When the number of original pages is odd and "[START] : NEXT SCAN [#] : START PRINT" appears, press the [#] key after all pages have been scanned.

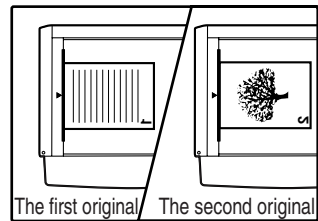

Note

- If you need to clear the data scanned into memory, press the [CLEAR] key (C). When the [CLEAR] key (C) is pressed, the number of copies setting is also cleared.
- To cancel automatic two-sided copying, press the [CLEAR ALL] key (CA) or press the [2-SIDED COPY] key, select the "1 TO 1", and then press the [ENTER] key.
- If the special function sort mode was selected in step 4, copying will not begin until the [#] key is pressed.

Using the RSPF

1 Place the original(s) in the RSPF. (p.21)

If you place an odd number of originals for one-sided to two-sided copying, the last page will be one-sided.

2 Press the [2-SIDED COPY] key*1 and select the two-sided copy mode that you wish to use.

The mode changes as follows each time you press the [2-SIDED COPY] key*1:

"1 TO 1" → "1 TO 2"*2 → "2 TO 2"*2 → "2 TO 1"

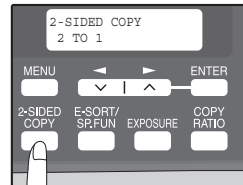

- "1 TO 2"*2: Two-sided copies from one-sided originals
- "2 TO 2"*2: Two-sided copies from two-sided originals
- "2 TO 1": One-sided copies from two-sided originals

*1 On the AR-208S, press the [2-SIDED SCAN] key.

*2 AR-208D only

3 Press the [ENTER] key.

If you selected "1 TO 2" in step 2, select "LONG EDGE" or "SHORT EDGE" and press the [ENTER] key. LONG EDGE and SHORT EDGE are shown in the illustration on page 26.

4 If you selected "2 TO 1" or "2 TO 2", press the [▼] key (▽) or [▶] key (▷) to select the original size and then press the [ENTER] key.

The following original sizes can be selected:

"8.5x14", "8.5x13", "8.5x11", "5.5x8.5", "A4", "B5", "A5"

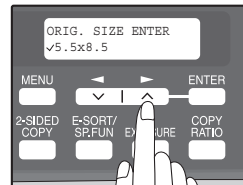

5 Select the number of copies and any other settings, and then press the [START] key (⊙).

The copy will be delivered to the paper output tray.



To cancel automatic two-sided copying, press the [CLEAR ALL] key (CA) or press the [2-SIDED COPY] key (On the AR-208S, press the [2-SIDED SCAN] key.), select the "1 TO 1", and then press the [ENTER] key.

SORT COPY

Copies of multiple original pages can be sorted into sets.



The number of pages that can be scanned varies depending on the original type (photo, text, etc.) and the amount of memory allocated to the printer. The amount of memory allocated to the printer can be changed with "MEM. FOR PRINTER" in the user programs. (p.56)

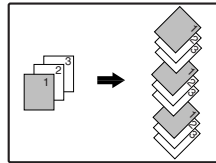

Sort copy

Using the document glass

1 Place the first original. (p.20)

2 Press the [E-SORT/SP.FUN] key until "SORT" appears and then press the [ENTER] key.

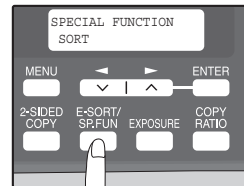

3 Press the [◀] key () to move "✓" to the "ON" position and then press the [ENTER] key.

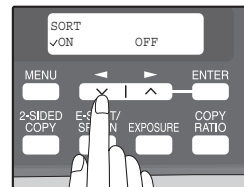

4 Select the number of copies and any other settings, and then press the [START] key ().

"[START] : NEXT SCAN [#] : START PRINT" appears and the original is scanned into memory.

5 Replace the original with the next original, and then press the [START] key ().

Repeat step 5 until all originals have been scanned into memory.



To clear the data in memory, press the [CLEAR] key (). When the [CLEAR] key () is pressed, the number of copies setting is also cleared.

6 When all originals have been scanned, press the [#] key.

The copies are delivered to the paper output tray.



- To cancel the sort copy job, press the [CLEAR] key ().
- To cancel sort copy mode, press the [CLEAR ALL] key ().

Using the RSPF

1 Place the originals. (p.21)



- If "SORT AUTO SELECT" is enabled in the user programs, the default output mode for copying from the RSPF is sort mode (p.57). In this case go directly to step 4. A checkmark "✓" will automatically appear in the display (p.11).
- If "SORT AUTO SELECT" is disabled, the default output mode will be non-sort mode. Follow the steps below to select sort mode.

2 Press the [E-SORT/SP.FUN] key until "SORT" appears and then press the [ENTER] key.

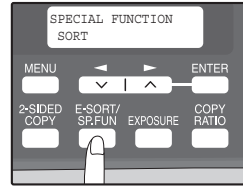

3 Press the [◀] key () to move "✓" to the "ON" position and then the [ENTER] key.

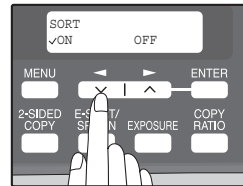

4 Select the number of copies and any other settings, and then press the [START] key ().

The copies are delivered to the paper output tray.



- To cancel the sort copy job, press the [CLEAR] key ().
- To cancel sort copy mode, press the [CLEAR ALL] key ().

If the memory becomes full

- If the memory becomes full while scanning the originals, "MEMORY FULL, PRESS START TO RESUME" will appear in the display, and the machine will stop copying.
- To copy the originals that have been scanned up to that point, press the [START] key ().
- To clear the data that has been scanned into memory, press the [CLEAR ALL] key () or the [CLEAR] key ().

Offset function during sort copy

The offset function shifts the position of each set of copies in the paper output tray for easy separation.

The offset function can be changed with "OFFSET FUNCTION" in the user programs. (p.55)

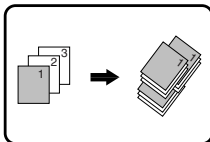

Offset function

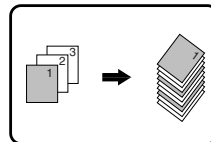

When offset function is disabled

COPYING MULTIPLE ORIGINALS ONTO A SINGLE SHEET OF PAPER (2 IN 1 copy)

Multiple originals can be copied onto a single sheet of paper in a selected layout pattern.

This function is convenient for compiling multi-page reference materials into a compact format, or for providing an overview of all pages of a document on a single page.

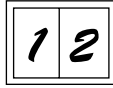

Pattern 1

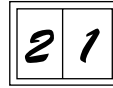

Pattern 2



- An appropriate ratio setting will be automatically selected based on the size of the originals, the size of the paper. When using the document glass, reduction is possible to 25%. When using the RSPF, reduction is possible to 50%. Certain combinations of original size and paper size may result in images being cut off.
- 2 IN 1 copying cannot be used in combination with the margin shift copying.
- The 2 IN 1 layout pattern can be changed with "LAYOUT IN 2IN1" in the user programs (p.55).
- The bypass tray cannot be used for 2 IN 1 copying.

Using the document glass

1 Place the first original. (p.20)

2 Press the [E-SORT/SP.FUN] key until "2IN1" appears and then press the [ENTER] key.

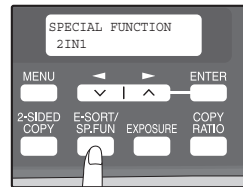

3 Press the [◀] key () to move "✓" to the "ON" position and then press the [ENTER] key.

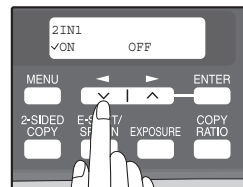

- 4** Press the [◀] key (◀) or [▶] key (▶) to select the original size and then press the [ENTER] key.

The following original sizes can be selected:
"8.5x14", "8.5x13", "8.5x11", "5.5x8.5", "A4", "B5",
"A5"

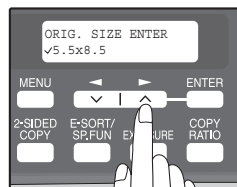

- 5** Select the number of copies and any other settings, and then press the [START] key (⊙).

"[START] : NEXT SCAN [#] : START PRINT" appears and the original is scanned into memory.

To immediately print the scanned image, press the [#] key.

- 6** Replace the original with the next original, and then press the [START] key (⊙).

Repeat step 6 until all originals have been scanned.

Copies will be output each time two originals have been scanned.

When the number of original pages is odd and "[START] : NEXT SCAN [#] : START PRINT" appears, press the [#] key after all pages have been scanned.



- To clear the data in memory, press the [CLEAR] key (C).
When the [CLEAR] key (C) is pressed, the number of copies setting is also cleared.
- To cancel 2 IN 1 copying, press the [CLEAR] key (C).
- To cancel 2 IN 1 copy mode, press the [CLEAR ALL] key (CA).

Using the RSPF

1 Place the originals. (p.21)

2 Press the [E-SORT/SP.FUN] key until "2IN1" appears and then press the [ENTER] key.

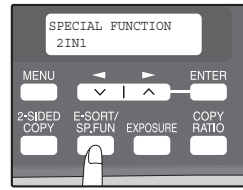

3 Press the [◀] key () to move "✓" to the "ON" position and then press the [ENTER] key.

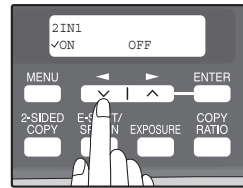

4 Press the [◀] key () or [▶] key () to select the original size and then press the [ENTER] key.

The following original sizes can be selected:
 "8.5x14", "8.5x13", "8.5x11", "5.5x8.5", "A4", "B5", "A5"

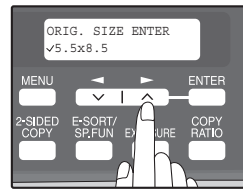

5 Select the number of copies and any other settings, and press the [START] key ().

The copy is delivered to the paper output tray.



- To cancel 2 IN 1 copying, press the [CLEAR] key ().
- To cancel 2 IN 1 copy mode, press the [CLEAR ALL] key ().

4

CREATING MARGINS WHEN COPYING

(Margin shift)

The margin shift function is used to automatically shift the text or image or the copy paper approximately 1/2".

As shown below, LONG EDGE or SHORT EDGE can be selected.

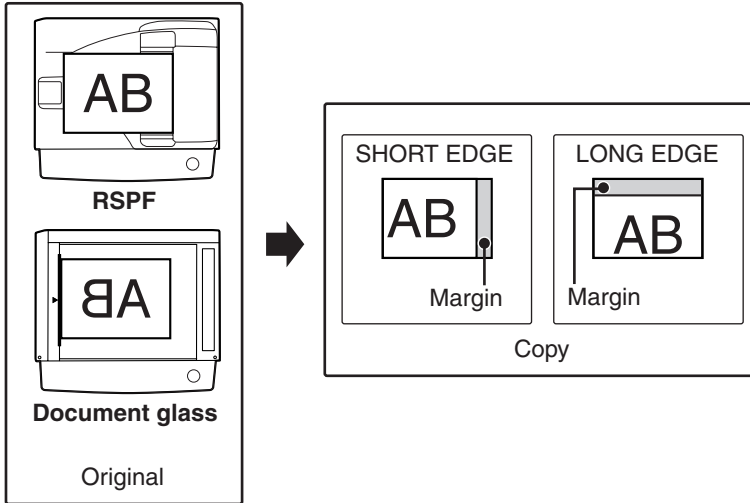

- This feature cannot be used with the 2 IN 1 feature.
- The margin width can be changed with "MARGIN WIDTH" in the user programs. (p.56)
- Note that a margin is created by shifting the image, and thus if the image is shifted too far, the edge of the image may be cut off.

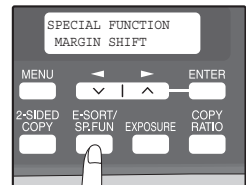

1 Place the original(s).

2 Press the [E-SORT/SP.FUN] key until "MARGIN SHIFT" appears and then press the [ENTER] key.

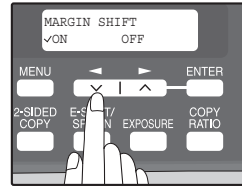

- 3** Press the [◀] key () to move "✓" to the "ON" position and then press the [ENTER] key.



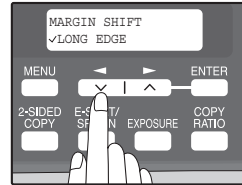

- 4** Press the [◀] key () or [▶] key () to select the margin position and then press the [ENTER] key.
 Select "LONG EDGE" or "SHORT EDGE".
 For the margin position, see the previous page.



- 5** Select the number of copies and any other settings, and then press the [START] key ().
 The copy is delivered to the paper output tray.



- To cancel margin shift copying, press the [CLEAR] key ().
- To cancel margin shift mode, press the [CLEAR ALL] key ().

This chapter explains how to install and configure the software that is required for the printer and scanner functions of the machine. The procedure for viewing the Online Manual is also explained.



This manual refers to the CD-ROM that accompanied the machine simply as "CD-ROM".

SOFTWARE

The CD-ROM that accompanies the machine contains the following software:

MFP driver

Printer driver

The printer driver enables you to use the printer function of the machine.

The printer driver includes the Print Status Window. This is a utility that monitors the machine and informs you of the printing status, the name of the document currently being printed, and error messages.

Scanner driver

The scanner driver allows you to use the scanning function of the machine with TWAIN-compliant and WIA-compliant applications.

Sharpdesk

Sharpdesk is an integrated software environment that makes it easy to manage documents and image files, and launch applications.

Button Manager

Button Manager allows you to use the scanner menus on the machine to scan a document.

BEFORE INSTALLATION

Hardware and software requirements

Check the following hardware and software requirements in order to install the software.

Computer type	IBM PC/AT or compatible computer equipped with a USB2.0 ^{*1} /1.1 ^{*2}
Operating system ^{*3} ^{*4}	Windows 98, Windows Me, Windows 2000 Professional ^{*5} , Windows XP ^{*5} , Windows Vista ^{*5}
Display	1024 x 768 dots resolution and 16-bit color or higher is recommended.
Hard disk free space	150 MB or more
Other hardware requirements	An environment on which any of the operating systems listed above can fully operate

^{*1} The machine's USB connector will transfer data at the speed specified by the USB 2.0 (Hi-Speed) only if the Microsoft USB 2.0 driver is installed in the computer.

^{*2} Compatible with Windows 98, Windows Me, Windows 2000 Professional, Windows XP or Windows Vista preinstalled model standardly equipped with a USB port.

^{*3} Printing is not available in MS-DOS mode.

^{*4} The machine does not support printing from a Macintosh environment.

^{*5} Administrator's rights are required to install the software using the installer.

INSTALLING THE SOFTWARE



Note

- The screen images in this manual are mainly for Windows XP. With other versions of Windows, some screen images may be different from those in this manual.
- In the following explanations it is assumed that the mouse is configured for right hand operation.
- If an error message appears, follow the instructions on the screen to solve the problem. After the problem is solved, the installation procedure will continue. Depending on the problem, you may have to click the "Cancel" button to exit the installer. In this case, reinstall the software from the beginning after solving the problem.

1 The USB cable must not be connected to the machine. Make sure that the cable is not connected before proceeding.

If the cable is connected, a Plug and Play window will appear. If this happens, click the "Cancel" button to close the window and disconnect the cable.



Note

The cable will be connected in step 13.

2 Insert the CD-ROM into your computer's CD-ROM drive.

3 Click the "start" button, click "My Computer" () , and then double-click the CD-ROM icon ().

- In Windows Vista, click the "Start" button, click "Computer", and then double-click the CD-ROM icon.
- In Windows 98/Me/2000, double-click "My Computer", and then double-click the CD-ROM icon.

4 Double-click the "setup" icon ().

In Windows Vista, if a message screen appears asking you for confirmation, click "Allow".

5 The "SOFTWARE LICENSE" window will appear. Make sure that you understand the contents of the software license, and then click the "Yes" button.



Note

You can show the "SOFTWARE LICENSE" in a different language by selecting the desired language from the language menu. To install the software in the selected language, continue the installation with that language selected.

6 Read the "Readme First" in the "Welcome" window and then click the "Next" button.

- 7** To install all of the software, click the "Standard" button and go to step 12. To install particular packages, click the "Custom" button and go to next step.

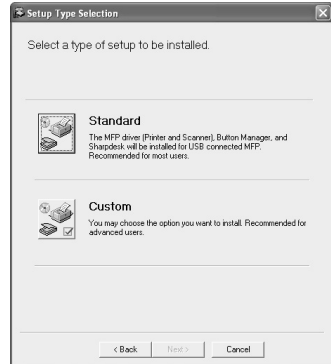

- 8** Click the "MFP Driver" button.

Click the "Display Readme" button to show information on packages that are selected.

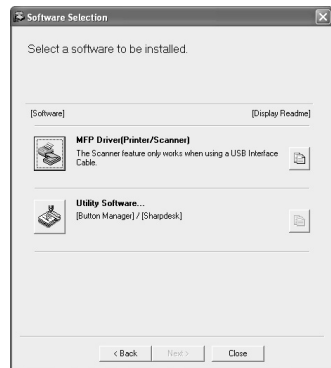

5

- 9** Select "Connected to this computer" and click the "Next" button.

Follow the on-screen instructions.

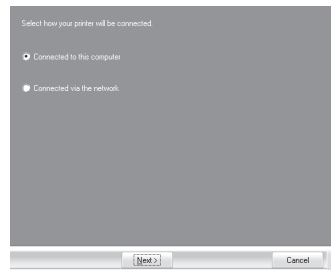

Caution

- If you are using Windows Vista and a security warning window appears, be sure to click "Install this driver software anyway".
- If you are running Windows 2000/XP and a warning message appears regarding the Windows logo test or digital signature, be sure to click "Continue Anyway" or "Yes".

10 You will return to the window of step 8. If you wish to install **Button Manager** or **Sharpdesk**, click the **"Utility Software"** button.

If you do not wish to install the Utility Software, click the "Close" button and go to step 12.



After the installation, a message prompting you to restart your computer may appear. In this case, click the "Yes" button to restart your computer.

Installing the Utility Software

11 Click the **"Button Manager"** or the **"Sharpdesk"** button.

Click the "Display Readme" button to show information on packages that are selected.

Follow the on-screen instructions.



In Windows 98/Me/2000, if the following screen appears, click the **"Skip"** button or the **"Continue"** button as appropriate to continue the Sharpdesk installation.

If "Skip" is selected, the Sharpdesk installation will continue without installing Sharpdesk Imaging.

If "Continue" is selected, Sharpdesk Imaging will be installed. If Imaging for Windows is installed on your computer, Sharpdesk Imaging will overwrite Imaging for Windows.

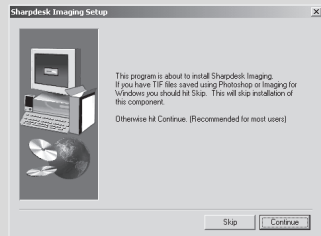

12 When installing is finished, click the "Close" button. **Caution**

- If you are using Windows Vista and a security warning window appears, be sure to click "Install this driver software anyway".
- If you are running Windows 2000/XP and a warning message appears regarding the Windows logo test or digital signature, be sure to click "Continue Anyway" or "Yes".

A message will appear instructing you to connect the machine to your computer. Click the "OK" button.

 **Note**

After the installation, a message prompting you to restart your computer may appear. In this case, click the "Yes" button to restart your computer.

13 Make sure that the power of the machine is turned on, and then connect the USB cable (p.42).

Windows will detect the machine and a Plug and Play screen will appear.

14 Follow the instructions in the plug and play window to install the driver.

Follow the on-screen instructions.

 **Caution**

- If you are using Windows Vista and a security warning window appears, be sure to click "Install this driver software anyway".
- If you are running Windows 2000/XP and a warning message appears regarding the Windows logo test or digital signature, be sure to click "Continue Anyway" or "Yes".

5**This completes the installation of the software.**

- If you installed Button Manager, set up Button Manager as explained in "SETTING UP BUTTON MANAGER" (p.45).
- If you installed Sharpdesk, the Sharpdesk setup screen will appear. Follow the instructions in the screen to set up Sharpdesk.

Connecting a USB cable

Follow the procedure below to connect the machine to your computer.

A USB cable for connecting the machine to your computer is not included with the machine. Please purchase the appropriate cable for your computer.

Caution

- USB is available with a PC/AT compatible computer that was originally equipped with USB and had Windows 98, Windows Me, Windows 2000 Professional, Windows XP or Windows Vista preinstalled.
- Do not connect the USB cable before installing the printer driver. The USB cable should be connected during installation of the printer driver.

Note

- If the machine will be connected using a USB 2.0 port of your computer, please purchase a USB cable that supports USB 2.0.
- To obtain the fastest USB 2.0 data transfer speed, "USB2.0 MODE SWITCH" in the machine's user programs must be set to "HI-SPEED". For more information, see "USER PROGRAMS" (p.58).
- Use the machine's "HI-SPEED" mode only when using a computer that is running Windows 2000/XP/Vista.
- Even when the Microsoft USB 2.0 driver is used, it may not be possible to obtain full USB 2.0 speed if a PC card supporting USB 2.0 is used. To obtain the latest driver (which may enable a higher speed), contact the manufacturer of your PC card.
- Connection is also possible using a USB 1.1 port on your computer. However, the specifications will be USB 1.1 specifications (Full-Speed).

- 1 Insert the cable into the USB connector on the machine.**

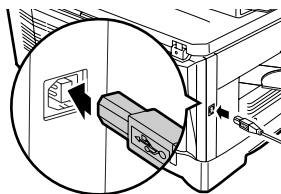

- 2 Insert the other end of the cable into your computer's USB port.**

Using the machine as a shared printer

If the machine will be used as a shared printer on a network, follow these steps to install the printer driver in the client computer.



To configure the appropriate settings in the print server, see the operation manual or help file of your operating system.

1 Perform steps 2 through 6 in "INSTALLING THE SOFTWARE" (p.38).

2 Click the "Custom" button.

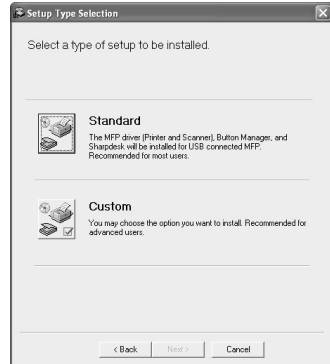

3 Click the "MFP Driver" button.

Click the "Display Readme" button to show information on packages that are selected.

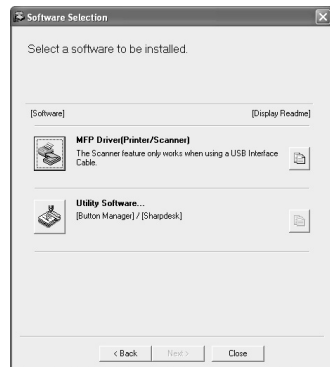

4 Select "Connected via the network" and click the "Next" button.

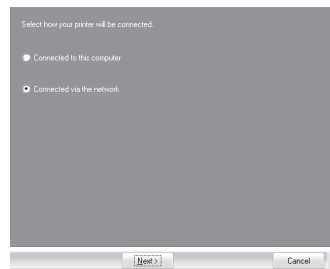

5 Click the "Add Network Port" button.

In Windows Vista, the "Add Network Port" button does not appear.

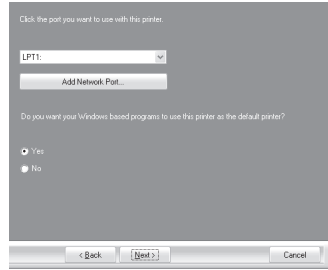

6 Select the network printer that is shared and click the "OK" button.

Ask your network administrator for the server name and printer name of the machine on the network.

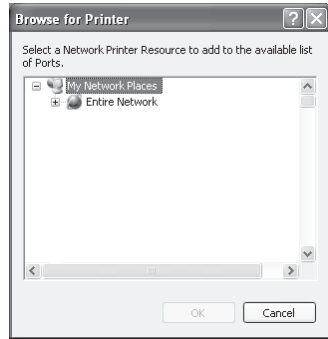

7 In the printer port selection window, verify the network printer that is shared and whether the machine is to be used as the default printer, make the selections and click the "Next" button.

Follow the on-screen instructions.

! Caution

- If you are using Windows Vista and a security warning window appears, be sure to click "Install this driver software anyway".
- If you are running Windows 2000/XP and a warning message appears regarding the Windows logo test or digital signature, be sure to click "Continue Anyway" or "Yes".

8 You will return to the window of step 3. Click the "Close" button.

Note

After the installation, a message prompting you to restart your computer may appear. In this case, click the "Yes" button to restart your computer.

This completes the installation of the software.

SETTING UP BUTTON MANAGER

Button Manager is a software program that works with the scanner driver to enable scanning from the machine.

To scan using the machine, Button Manager must be linked with the scan menu on the machine. Follow the steps below to link Button Manager to scanner events.

Windows XP/Vista

- 1** Click the "start" button, click "Control Panel", click "Printers and Other Hardware", and then click "Scanners and Cameras".

In Windows Vista, click the "Start" button, select "Control Panel" and click "Hardware and Sound", and then click "Scanners and Cameras".

- 2** Click the "SHARP AR-XXXX" icon and select "Properties" from the "File" menu.

In Windows Vista, select "Properties" from the "Organize" menu.

- 3** In the "Properties" screen, click the "Events" tab.

- 4** Select "SC1:" from the "Select an event" pull-down menu.

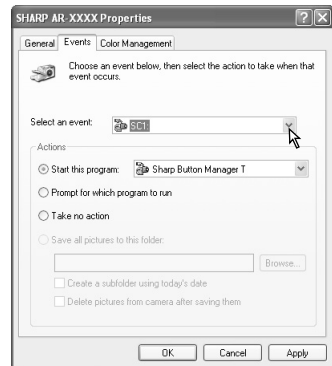

5

- 5** Select "Start this program" and then select "Sharp Button Manager T" from the pull-down menu.

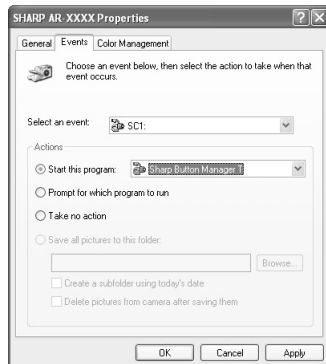

- 6** Click the "Apply" button.

- 7** Repeat Steps 4 through 6 to link Button Manager to "SC2:" through "SC6:".

Select "SC2:" from the "Select an event" pull-down menu. Select "Start this program", select "Sharp Button Manager T" from the pull-down menu, and then click the "Apply" button. Do the same for each ScanMenu through "SC6:".

When the settings have been completed, click the "OK" button to close the screen.

Button Manager is now linked to the scan menu (1 through 6).

The scan settings for each of scan menu 1 through 6 can be changed with the setting window of Button Manager.

For the factory default settings of the scan menu and the procedures for configuring Button Manager settings, see "Button Manager Settings" in the Online Manual.

Windows 98/Me/2000

1 Click the "Start" button, select "Settings", and then click "Control Panel".

2 Double-click the "Scanners and Cameras" icon.



If the "Scanners and Cameras" icon does not appear in Windows Me, click "view all Control Panel options".

3 Select "SHARP AR-XXXX" and click the "Properties" button.

In Windows Me, right click "SHARP AR-XXXX" and click "Properties" in the pop-up menu.

4 In the "Properties" screen, click the "Events" tab.

5 Select "SC1:" from the "Scanner events" pull-down menu.

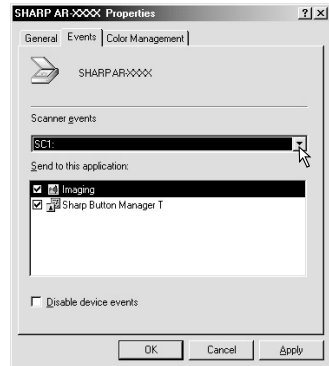

5

6 Select "Sharp Button Manager T" in "Send to this application".

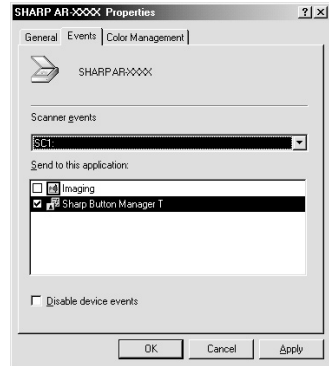

If other applications are shown, deselect the checkboxes for the other applications and leave only the Button Manager checkbox selected.

7 Click the "Apply" button.

8 Repeat Steps 5 through 7 to link Button Manager to "SC2:" through "SC6:".

Select "SC2:" from the "Scanner events" pull-down menu. Select "Sharp Button Manager T" in "Send to this application" and click the "Apply" button. Do the same for each ScanMenu through "SC6:". When the settings have been completed, click the "OK" button to close the screen.

Button Manager is now linked to the scan menu (1 through 6). The scan settings for each of scan menus 1 through 6 can be changed with the setting window of Button Manager. For the factory default settings of the scan menu and the procedures for configuring Button Manager settings, see "Button Manager Settings" in the Online Manual.

The machine includes a USB connector as standard equipment.

The machine has the following features:

- High-speed data transfer (when connected to a USB 2.0 connector)
- ROPM* function

* ROPM is an acronym for "Rip Once Print Many" processing. The ROPM function stores multiple pages of print data in memory before printing. When printing multiple copies, this eliminates the need for the computer to repeatedly transmit the print data.

To use the machine as a printer or scanner, the printer driver or scanner driver must first be installed as explained in the "INSTALLING THE SOFTWARE".

**Note**

- If a problem occurs in printer or scanner mode, see the Online Manual.
- When using USB 2.0 (Hi-Speed mode), be sure to read "System requirements for USB 2.0 (Hi-Speed mode)" (below) to verify that your system and the machine settings are configured appropriately.

System requirements for USB 2.0 (Hi-Speed mode)

The following system is required to use USB 2.0 (Hi-Speed mode):

- Your computer must be running Windows 2000 Professional/XP/Vista and the Microsoft USB 2.0 driver must be installed.
- The "USB 2.0 MODE SWITCH" setting in the machine's user programs must be set to "HI-SPEED". To change the setting, see "USB 2.0 MODE SWITCH" in the user programs (p.58).
- * Even when the Microsoft USB 2.0 driver is installed, some USB 2.0 expansion cards are not capable of attaining the speed stipulated by the Hi-Speed standard. This problem can often be fixed by installing a more recent driver for the card. To obtain the most recent driver for your card, contact the card's manufacturer.

USING THE PRINTER MODE

The procedure for loading paper for printing is the same as for loading copy paper. See "LOADING PAPER" (p.14).



- Print jobs received while the machine is copying will be stored in memory. When the copy job is finished, the print jobs will begin printing.
- Printing is not possible when the front or side cover is opened for machine maintenance, or when a misfeed occurs or the machine runs out of paper or toner.

BASIC PROCEDURE FOR PRINTING

The basic procedure for printing is explained in the following. To use convenient printer functions, see the "Online Manual" or the printer driver help file.

1 Make sure that paper is loaded in the tray.

The procedure for loading paper is the same as for copying. See "LOADING PAPER" (p.14) and make sure that the paper you wish to use is loaded.



Make sure that the paper size setting on the machine is the same as the paper size set in the printer driver.

2 Open the file that you wish to print and select "Print" from the File menu.

3 Make sure that the printer driver for the machine is selected, and select print settings in the printer driver.

For information on the settings in the printer driver, see the "Online Manual" or the printer driver help file.

4 Click the "Print" button or the "OK" button to begin printing.

The print job will be delivered to the paper output tray.

Canceling a print job

1 Select printer mode with the [MODE SELECT] key on the operation panel of the machine, and then press the [CLEAR] key (C) or the [CLEAR ALL] key (CA).

2 "CANCEL PRINT JOB?" will appear in the display. Make sure that a checkmark appears in front of "YES" and press the [ENTER] key.



For limitations on copying in print mode, scanner mode limitations, and print mode limitations in copy and scanner mode, see "OPERATION IN COPY, PRINTER, AND SCANNER MODES" (p.52).

USING THE SCANNER MODE

The procedure for placing the original is the same as for copying. See "NORMAL COPYING" (p.20).



Scanner mode cannot be used at the following times:

- A misfeed has occurred (paper misfeed or original misfeed in the RSPF).
- The user programs are being used.
- The tray paper size is being set.
- The machine is being used in copy mode.
- The front cover or side cover is open.

SCANNING USING THE KEYS ON THE MACHINE

When scanning is performed by this method, the application that has been set in Button Manager will automatically start and the scanned image will be pasted into the application.



If the machine is in copy mode, press the [MODE SELECT] key to switch to scanner mode and clear the previously set copy settings.

Scanning from the operation panel of the machine

- 1 Press the [MODE SELECT] key to select scanner mode.**

The "SCAN" indicator lights up to indicate that scanner mode is selected.

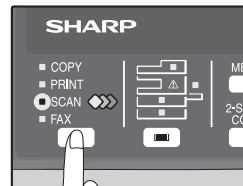

- 2 Place the original. (p.20)**

- 3 Press the [◀] key () or [▶] key () to select the desired Button Manager scan menu setting.**

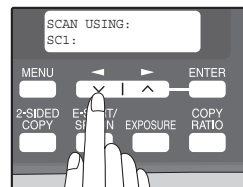

- 4 Press the [START] key () to begin scanning.**



Scanner mode remains selected after scanning is finished. (To change to a different mode, use the [MODE SELECT] key.)

Button Manager scan menu

For information on Button Manager settings, see the Button Manager help file. The names in the Button Manager menu ("xxxx" in "SC1:xxxx", etc.) can be changed. See the online manual.

SCANNING FROM YOUR COMPUTER

The machine supports the TWAIN standard, making it possible to scan from TWAIN-compliant applications. The machine also supports WIA (Windows Image Acquisition), making it possible to scan from the "Scanner and Camera Wizard" in Windows XP. See the Online Manual for the procedures for TWAIN and WIA scanning. For information on TWAIN and WIA settings, see the help file for the scanner driver or Windows Help.

OPERATION IN COPY, PRINTER, AND SCANNER MODES

Some operations cannot be performed simultaneously when the machine is being used in printer mode, copy mode, or scanner mode.

Modes		Copying	Printing	Scanning from a computer	Scanning from the machine
Copy	Copy key input	Yes	Yes	Yes	No
	During copying		No	No	No
Printer	During printing	Yes*		Yes	Yes
Scanner	During scan preview/ during scanning	No	Yes		

* During two-sided printing (AR-208D only), the copy job begins after the print job finishes.

HOW TO USE THE ONLINE MANUAL

The online manual provides detailed instructions for operating the unit as a printer and scanner. It also provides methods for dealing with printing or scanner problems.

1 Turn on your computer.

2 Insert the supplied CD-ROM into your CD-ROM drive.

3 Click the "start" button, click "My Computer" () , and then double-click the CD-ROM () icon.

- In Windows Vista, click the "Start" button, click "Computer", and then double-click the CD-ROM icon.
- In Windows 98/Me/2000, double-click "My Computer" and then double-click the CD-ROM icon.

4 Double-click the "Manual" folder, double-click the "EnglishA" folder, and then double-click the "AR_208S_208D.pdf" icon.

5 Click  to read the online manual.

To close the online manual, click the () button located at the top-right of the window.



- The online manual can be printed out using Acrobat Reader. It is useful to print out sections that you refer to frequently.
- Refer to Acrobat Reader "Help" for more details on the operation and functions of Acrobat Reader.

Viewing the online manual

The "CD-ROM" that accompanies the machine contains an online manual in PDF format. To view the manual in PDF format, Acrobat Reader or Adobe Reader of Adobe Systems Incorporated is required. If neither program is installed on your computer, the programs can be downloaded from the following URL:

<http://www.adobe.com/>

7 Chapter 7 USER SETTINGS

The user settings allow you to customize machine settings to better meet your needs.



USER PROGRAMS

The user settings consist of the following items.

To change a user program setting, see "SELECTING A SETTING FOR A USER PROGRAM" (p.59).

Copy mode

Program number	Program name	Setting codes (factory default setting appears in bold)	Explanation
1	AUTO CLEAR	1: 10 SEC. 2: 30 SEC. 3: 60 SEC. 4: 90 SEC. 5: 120 SEC. 6: OFF	<ul style="list-style-type: none">• Auto clear time automatically returns the copy settings to the initial settings (p.12) if no keys are pressed for a preset period of time following the end of a copy job.• This program is used to select the period of time. Auto clear time can also be disabled.
2	PREHEAT MODE	1: 30 SEC. 2: 1 MIN. 3: 5 MIN. 4: 30 MIN. 5: 60 MIN. 6: 120 MIN. 7: 240 MIN.	<ul style="list-style-type: none">• This function automatically switches the machine to a low power consumption state if the set duration of time elapses without the machine being used when the power is on. The power save indicator lights up, however, the keys on the operation panel can be used. Normal operation automatically resumes when a key on the operation panel is pressed, an original is placed, a print job is received.
3	AUTO SHUT-OFF	1: ON 2: OFF	<ul style="list-style-type: none">• Use this setting to enable or disable auto power shut-off mode.

Program number	Program name	Setting codes (factory default setting appears in bold)	Explanation
4	AUTO SHUT-OFF TIME	1: 5 MIN. 2: 30 MIN. 3: 60 MIN. 4: 120 MIN. 5: 240 MIN.	<ul style="list-style-type: none"> This function automatically switches the machine to a state that consumes even less power than preheat mode if the set duration of time elapses without the machine being used when the power is on. All lights except the power save indicator go off. To resume normal operation, press the [START] key (). Normal operation also resumes automatically when a print job is received or scanning is begun from a computer. While in auto power shut-off mode, no keys (except the [START] key ()) can be used.
7	LAYOUT IN 2IN1	1: PATTERN 1 2: PATTERN 2	<ul style="list-style-type: none"> Use this setting to select the layout pattern when two original pages are copied onto a single sheet of paper (see page 31 for the layout patterns).
8	OFFSET FUNCTION	1: ON 2: OFF	<ul style="list-style-type: none"> When enabled, this function offsets the position of each set of copies in the output tray in copy mode, and each print job in printer mode.
9	ROTATE ORIG. IMAGE*	1: ON 2: OFF	<ul style="list-style-type: none"> When two-sided copying is performed, this function rotates the image on the back of the original. This is convenient when binding the copies at the top (tablet binding).
10	AE/TEXT RESOLUTION	1: 300dpi 2: 600dpi	<ul style="list-style-type: none"> This setting is used to change the copy resolution in AUTO and TEXT mode from 600 x 300 dpi to 600 x 600 dpi (high-quality mode). Scanning is slower when high-quality mode is used.

* AR-208D only

USER SETTINGS

Program number	Program name	Setting codes (factory default setting appears in bold)	Explanation
11	2-SIDED COPY MODE*	1: HI-SPEED 2: NORMAL	<ul style="list-style-type: none"> If the memory fills up when two-sided copying is performed, "NORMAL" can be selected to make copying possible. However, "NORMAL" results in a slower copying speed. Normally "HI-SPEED" is selected to enable fast two-sided copying.
12	MARGIN WIDTH	1: 1/4" 2: 1/2" 3: 3/4" 4: 1"	<ul style="list-style-type: none"> Use this setting to set the margin width.
13	MEM. FOR PRINTER	1: 30% 2: 40% 3: 50% 4: 60% 5: 70%	<ul style="list-style-type: none"> Use this to change the proportion of machine memory used for printer mode.
14	AUTO KEY REPEAT	1: ON 2: OFF	<ul style="list-style-type: none"> Use this setting to select whether or not holding down a key causes repeated input of the key. For keys that normally cause a set value to decrease or increase when held down (for example, the [◀] key (◀) or [▶] key (▶)), this program can be used to have the set value not change when the key is held down.
15	KEY PRESS TIME	1: NORMAL 2: 0.5 SEC. 3: 1.0 SEC. 4: 1.5 SEC. 5: 2.0 SEC.	<ul style="list-style-type: none"> Use this setting to select how long a key must be pressed for the input to be accepted. By selecting a longer time, you can prevent settings from being changed by the accidental pressing of a key.
16	KEY TOUCH SOUND	1: LOW 2: HIGH 3: OFF	<ul style="list-style-type: none"> This sets the volume of beep signals. (p.60)
17	SOUND AT DEFAULT	1: ON 2: OFF	<ul style="list-style-type: none"> Use this to sound a beep when a base setting is selected. (p.60)
18	TONER SAVE MODE	1: ON 2: OFF	<ul style="list-style-type: none"> This mode reduces toner usage by about 10% when copying. Toner save mode is effective when the exposure mode is AUTO or TEXT.

* AR-208D only

Program number	Program name	Setting codes (factory default setting appears in bold)	Explanation
19	AE LEVEL ADJUST	1: SPFF/RSPF (Adjustment to 5 levels is possible.) 2: DOCUMENT GLASS (Adjustment to 5 levels is possible.)	<ul style="list-style-type: none"> • This is used to adjust the exposure level. • The automatic exposure level can be adjusted separately for the document glass and the RSPF. • For the procedure for adjusting the exposure and guidelines for numeric values, see page 24. The factory default setting for the exposure level is center.
20	LANGUAGE	1: AMERICAN ENGLISH 2: ENGLISH 3: FRENCH 4: SPANISH	<ul style="list-style-type: none"> • This is used to set the language used in the display.
21	RESET FACTORY	1: YES 2: NO	<ul style="list-style-type: none"> • This is used to return all settings to the factory default settings.
22	SORT AUTO SELECT	1: ON 2: OFF	<ul style="list-style-type: none"> • Use this setting to enable or disable sort auto select mode.
24	CHECK RSPF OPEN	1: ON 2: OFF	<ul style="list-style-type: none"> • You can set the operation that takes place if the [START] key () is pressed when the RSPF is not completely closed. (For details on the "Check RSPF open function", see page 13.)
25	VALID COPY WIDTH	1: 8.5x11 2: 5.5x8.5	<ul style="list-style-type: none"> • Set the allowed paper sizes for copying from the bypass tray. When "5.5x8.5" is selected, a copy of a letter size original will only be printed up to invoice size.
28	LSU SETTING	1: ON 2: OFF	<ul style="list-style-type: none"> • Select whether copying is only allowed when the polygon motor is rotating, or also when the polygon motor is stopped.
29	PAPER TYPE	1: PLAIN PAPER 2: HEAVY PAPER	<ul style="list-style-type: none"> • Set the temperature of the fusing unit when the bypass tray is used. Normally "PLAIN PAPER" should be selected.
30	DISPLAY CONTRAST	1: LIGHTER 2: LIGHT 3: NORMAL 4: DARK 5: DARKER	<ul style="list-style-type: none"> • Set the contrast of the display.

USER SETTINGS

Print mode

Program number	Program name	Setting codes (factory default setting appears in bold)	Explanation
1	FORCED OUTPUT	1: ON 2: OFF	<ul style="list-style-type: none">When this function is enabled, printing in printer mode will automatically continue using a different size of paper if the specified size of paper runs out in all trays. This feature does not function in copy mode.
2	USB 2.0 MODE SWITCH* ¹	1: FULL-SPEED 2: HI-SPEED	<ul style="list-style-type: none">This sets the USB 2.0 data transfer speed. To obtain the fastest speed when using the USB 2.0 connector, first verify that your computer meets the system requirements (operating system and driver), and then use this program to change the USB 2.0 mode to "Hi-Speed". Note that the setting should not be changed while running a TWAIN driver. (For the system requirements, see "System requirements for USB 2.0 (Hi-Speed mode)" (p.49).)
3	AUTO TRAY SWITCH* ²	1: ON 2: OFF	<ul style="list-style-type: none">If the paper runs out during printing and there is paper of the same size in another tray, this function automatically switches to that tray (excluding the bypass tray). The function can be disabled.

*¹ The scanning speed increases when the USB 2.0 mode is set to "HI-SPEED", however, the printing speed does not increase considerably.

*² When the 250-sheet paper feed unit is installed.

SELECTING A SETTING FOR A USER PROGRAM

- 1 Press the [MENU] key and then press the [ENTER] key.**

In printer mode, the user programs are accessed by simply pressing the [MENU] key.

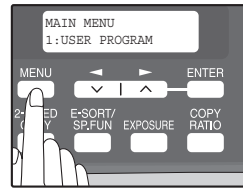

- 2 Press the [◀] key (▽) or [▶] key (△) to select the item that you wish to configure in the USER PROGRAM items, and then press the [ENTER] key.**

- See "USER PROGRAM" (p.54 to p.58) for the program name and program code.
- You can also select a program by directly entering the program number with the numeric keys.

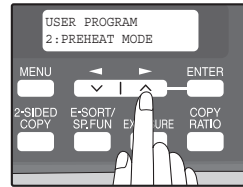

- 3 Press the [◀] key (▽) or [▶] key (△) to change the setting of the selected item.**

See "USER PROGRAM" (p.54 to p.58) for the program code.

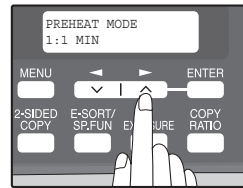

- If you mistakenly select the wrong item, press the [CLEAR] key (□) and repeat the procedure from step 2.
- To cancel a setting for a user program, press the [MENU] key.

- 4 Press the [ENTER] key.**

Your selection appears briefly and then the previous screen appears.



When "AE LEVEL ADJUST" is selected in the user programs and the [ENTER] key is pressed, the automatic exposure adjustment screen appears. Adjust the exposure and press the [ENTER] key.

USER SETTINGS

Audible signals (key entry beep, invalid key beep, base setting beep)

The machine sounds three different types of beep signals: a key entry beep that sounds when a valid key is pressed, an invalid key beep that sounds when an invalid key is pressed, and a base setting beep that sounds when a setting is the same as the base setting (base settings are explained below). The base setting beep is initially disabled. If you wish to enable the base setting beep, see "SOUND AT DEFAULT" on page 56. If you wish to change the volume of the beep signals or disable them, see "KEY TOUCH SOUND" on page 56.

The beep patterns of each type of beep signal are as follows:

Key entry beep One beep **Invalid key beep** Two beeps
Base setting beep Three beeps

Base settings

The base settings are preset standard selections for each copy setting. The base settings are as follows:

Copy ratio 100% **Paper feed location** Tray 1
Light and Dark level Center (Upper paper tray)
AUTO/TEXT/PHOTO AUTO

Problems related to general use of the machine, the copy function, and software setup are explained here. Be sure to check the problem carefully before calling for service, as many problems can be solved by the user.

If you are unable to solve the problem, turn off the main switch, unplug the power cord from the outlet, and contact your dealer.



For problems related to the printer and scanner functions, see the online manual.

DISPLAY MESSAGES

When the following indicators light up or blink on the operation panel or the following alphanumeric codes appear in the display, solve the problem immediately referring to both the table below and the indicated page.



Be sure to use only genuine SHARP parts and supplies.

Indication		Cause and remedy	Page	
Lamp indicator	Display			
Tray location indicator	Blinks	BYPASS : ADD PAPER	15	
		TRAY<*> : ADD PAPER		
		CLOSE PAPER TRAY<*>		
Error indicator	Blinks	CLEAR PAPER JAM.	70	
		SPF/RSPF JAM.		
		FRONT OR SIDE COVER OPEN. CLOSE COVERS.	-	
		CLOSE THE SPF/RSPF COVER.	-	
		REPLACE THE TONER CARTRIDGE.	74	
		SYSTEM ERROR [XX - XX] REFER TO USER GUIDE	When [L1-00] appears, the scan head locking switch is locked. Turn off the power, release the scan head locking switch, and turn the power back on.	76
			When [F2-02] appears, check the toner cartridge and make sure that the seal is not still affixed.	-
	The machine will not function. Turn the power switch off, wait about 10 seconds, and then turn on the switch again. If this does not clear the error, remove the power cord from the outlet, and contact your SHARP service center.	-		

TROUBLESHOOTING AND MAINTENANCE

Indication		Cause and remedy	Page
Lamp indicator	Display		
Error indicator	Blinks	INSTALL A TONER CARTRIDGE. The toner cartridge is not installed correctly. Reinstall the toner cartridge.	74
	Steadily lit	TONER CARTRIDGE IS NEAR EMPTY. Replacement of toner cartridge will be needed soon. Prepare a new cartridge.	74
		MAINTENANCE REQUIRED CALL FOR SERVICE Service by an authorized SHARP service technician is required.	-
MEMORY FULL, PRESS START TO RESUME.		Data is being held in memory. Print the data or clear it from memory.	30
NO 2-SIDED COPY FROM BYPASS TRAY.		Two sided printing or 2 IN 1 copying is selected when the bypass tray is already selected ,or the bypass tray is selected when two-sided printing or 2 IN 1 copying is already selected. The bypass tray cannot be used. Press the [TRAY SELECT] key (☐) to select a paper tray.	26 31
NO 2IN1 COPY FROM BYPASS TRAY.			
NO 2IN1 COPY WITH MARGIN SHIFT.		2 IN 1 copy and margin shift cannot be used in combination. Cancel the function that was selected last.	31 34
COPY RATIO CAN NOT BE CHANGED IN 2IN1.		Copy ratio can not be changed in 2 IN 1 copy.	25 31
THIS MENU IS NOT SELECTABLE WITH DATA.		This appears if you attempt to change a user program setting while a print job is in progress.	54
NO XXXX SIZE TRAY		There is no paper for printing. Press the [MODE SELECT] key to switch to printer mode and follow the instructions in the display. ("XXXX" indicates paper size)	-
CHECK SPF/RSPF. START TO RESUME.		An original remains on the document glass, or the original is too thick to scan. Remove the original.	21
		If the message is not cleared when there is no original on the document glass, the underside of the RSPF is dirty. Clean the underside of the RSPF. (especially areas where black lines appear.)	78
LOAD XXXX PAPER INTO TRAY<*>.		Printing is not possible if the paper size setting is different from the size of paper loaded in the tray. Load the same size of paper as the paper size setting and then press the [START] key (⊙). Printing will begin. ("XXXX" indicates paper size. The tray is indicated in <*>.)	15
NO PC COMMUNICATION; CHECK CABLE.		The machine is not correctly connected to the computer. Check the cable (when using the scanner function).	42

TROUBLESHOOTING THE MACHINE

The following problems are related to the general operation of the machine and copying.

Problem	Cause and solution	Page
The machine does not operate.	The machine is not plugged into a power outlet. → Plug the machine into a grounded outlet.	-
	Power switch OFF. → Turn the power switch ON.	12
	The power save indicator is blinking. Indicates that the machine is warming up. → Copies cannot be made until the machine has finished warming up.	-
	The front cover or the side cover is not completely closed. → Close the front cover or the side cover.	-
	The machine is in auto power shut-off mode. → In auto power shut-off mode, all lights are off except the power save indicator. Press the [START] key (⊙) to resume normal operation.	13
	The scan head locking switch is locked. → Unlock the scan head locking switch.	76
Copies are too dark or too light.	Select the correct original type for the original. → Select AUTO with the [EXPOSURE] key or press the [◀] key (▽) or [▶] key (△) to manually select an appropriate exposure.	24
	→ If the copy is too light or too dark even though AUTO was selected with the [EXPOSURE] key, adjust the automatic exposure level.	57
Blank copies.	The original is not placed face up in the RSPF or face down on the document glass. → Place the original face up in the RSPF or face down on the document glass.	20, 21
	The scan head locking switch is locked. → Unlock the scan head locking switch.	76

TROUBLESHOOTING AND MAINTENANCE

Problem	Cause and solution	Page
Part of the image is cut off or there is too much blank space.	The original was not placed in the correct position. → Place the original correctly.	20, 21
	An appropriate ratio was not used for the size of the original and the size of the paper. → Press the [COPY RATIO] key to change the ratio to a setting that is suitable for the original and the copy paper.	25
	The size of paper loaded in the tray was changed without changing the tray's paper size setting. → Be sure to change the tray's paper size setting whenever you change the size of paper loaded in the tray.	19
Wrinkles appear in the paper or the image disappears in places.	The paper is outside of the specified size and weight range. → Use copy paper within the specified range.	14
	Paper curled or damp. → Do not use curled or crimped paper. Replace with dry copy paper. During periods when the machine is not used for a long time, remove the paper from the tray and store it in a dark place in a bag to prevent moisture absorption.	-
Copies are smudged or dirty.	The document glass or the underside of the RSPF is dirty. → Clean regularly.	78
	Original smudged or blotchy. → Use a clean original.	-
Images rub off the copy easily.	The fusing temperature is not appropriate. → In the user programs, set "PAPER TYPE" (program 29) to "2 (HEAVY PAPER)".	57
Printing is not uniform between the edges of the paper and the center.	The fusing temperature is not appropriate. → In the user programs, set "PAPER TYPE" (program 29) to "1 (PLAIN PAPER)".	57

Problem	Cause and solution	Page
Paper misfeed.	Misfeed occur. → To remove the misfeed, see "MISFEED REMOVAL".	70
	The paper is outside of the specified size and weight range. → Use copy paper within the specified range.	14
	Paper curled or damp. → Do not use curled or crimped paper. Replace with dry copy paper. During periods when the machine is not used for a long time, remove the paper from the tray and store it in a dark place in a bag to prevent moisture absorption.	-
	Paper is not loaded properly. → Make sure that the paper is properly loaded.	15
	Pieces of paper inside machine. → Remove all pieces of misfed paper.	71
	Too much paper is loaded in the tray. → If the stack of paper is higher than the indicator line on the tray, remove some of the paper and reload so that the stack does not exceed the line.	15
	Some sheets of paper stick together. → Fan the paper well before loading it.	15
	The guides on the bypass tray do not match the width of the paper. → Adjust the guides to match the width of the paper.	18
	The bypass tray extension is not opened. → When loading a large size of paper, open the extension.	18
White or black lines appear on copies.	The scanner glass for the RSPF is dirty. → Clean the long, narrow scanning window.	78
	The transfer charger is dirty. → Clean the transfer charger.	79

TROUBLESHOOTING AND MAINTENANCE

Problem	Cause and solution	Page
Paper size for a paper tray cannot be set.	Copying or printing is performed. → Set the paper size after copying or printing is complete.	-
	The machine has stopped temporarily due to running out of paper or a misfeed. → Load paper or remove the misfeed, and then set the paper size.	19, 70
Output does not stack neatly in the paper output tray.	Both ends of the paper are curled upward. → Turning the paper over in the paper tray may help.	15
A copy job stops before it is finished.	"MEMORY FULL, PRESS START TO RESUME." appears in the display. → The memory became full during sort copy. Copy only the originals that have been scanned to that point, or cancel the job and clear the data from memory.	30
	The tray is out of paper. → Load paper.	15
The power save indicator is lit.	Other indicators are lit. → If other indicators are lit, the machine is in preheat mode. Press any key on the operation panel to resume normal operation.	13
	Only the power save indicator is lit. → If only the power save indicator is lit, the machine is in auto power shut-off mode. Press the [START] key (⊙) to resume normal operation.	13
Error indicator (⚠) is lit or blinking.	See "DISPLAY MESSAGES" to check the meaning of the error indicator and error message in the display, and take appropriate action.	61
Lighting fixture flickers.	The same power outlet is used for the lighting fixture and the machine. → Connect the machine to a power outlet which is not used for other electric appliances.	-

PROBLEMS DURING SETUP OF THE SOFTWARE

If the software does not install correctly, check the following items on your computer. To remove the software, see "Removing the software" (p.69).

MFP driver cannot be installed (Windows 2000/XP)

If the MFP driver cannot be installed in Windows 2000/XP, follow these steps to check your computer's settings.

1 Click the "start" button and then click "Control Panel".

In Windows 2000, click the "Start" button, select "Settings", and then click "Control Panel".

2 Click "Performance and Maintenance", and then click "System".

In Windows 2000, double-click the "System" icon.

3 Click the "Hardware" tab and then click the "Driver Signing" button.

4 Check "What action do you want Windows to take?" ("File signature verification" in Windows 2000).

If "Block" has been selected, it will not be possible to install the MFP driver. Select "Warn" and then install the MFP driver as explained in "INSTALLING THE SOFTWARE".



Plug and play screen does not appear

If the Plug and Play screen does not appear after you connect the machine to your computer with a USB cable and turn on the machine, follow the steps below to verify that the USB port is available.

1 Click the "start" button, click "Control Panel", and then click "Performance and Maintenance".

- In Windows Vista, click the "Start" button, select "Control Panel", and then click "System and Maintenance".
- In Windows 98/Me/2000, click the "Start" button, select "Settings", and then click "Control Panel".

2 Click "System", click the "Hardware" tab, and click the "Device Manager" button.

"Universal Serial Bus controllers" will appear in the list of devices.



- In Windows 98/Me, double-click the "System" icon and click the "Device Manager" tab.
- In Windows 2000, double-click the "System" icon, click the "Hardware" tab, and click the "Device Manager" button.
- In Windows Vista, click the "Device Manager", and if a message screen appears asking you for confirmation, click "Continue".
- If the "System" icon does not appear in Windows Me, click "view all Control Panel options".

3 Click the icon beside "Universal Serial Bus controllers".

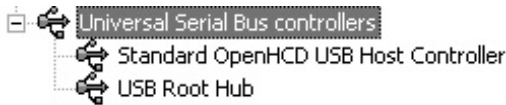

Two items should appear: your controller chipset type and Root Hub. If these items appear, you can use the USB port. If the "Universal Serial Bus controllers" shows a yellow exclamation point or does not appear, you must check your computer manual for USB troubleshooting or contact your computer manufacturer.

4 Once you have verified that the USB port is enabled, install the software as explained in "INSTALLING THE SOFTWARE".

The MFP driver cannot be correctly installed by Plug and Play (Windows 2000/XP/Vista)

In Windows 2000/XP/Vista, if the MFP driver cannot be correctly installed by Plug and Play (for example, Plug and Play takes place without copying the required files for the MFP driver installation), follow these steps to remove unneeded devices and then install the MFP driver as explained in "INSTALLING THE SOFTWARE" (p.36).

1 Click the "start" button, click "Control Panel", and then click "Performance and Maintenance".

- In Windows Vista, click the "Start" button, select "Control Panel", and then click "System and Maintenance".
- In Windows 2000, click the "Start" button, select "Settings", and then click "Control Panel".

2 Click "System", click the "Hardware" tab, and click the "Device Manager" button.



Note

- In Windows 2000, double-click the "System" icon, click the "Hardware" tab, and click the "Device Manager" button.
- In Windows Vista, click the "Device Manager", and if a message screen appears asking you for confirmation, click "Continue".

3 Click the icon beside "Other devices".

If "AR-XXXX" and "SHARP AR-XXXX" appear, select and delete both of these items.

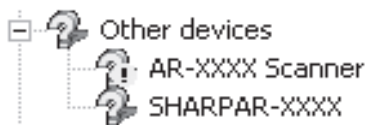

Note

If "Other devices" does not appear, close the "Device Manager" window.

4 Install the software as explained in "INSTALLING THE SOFTWARE".

Removing the software

If you need to remove the software, follow these steps.

1 Click the "start" button and then click "Control Panel".

In Windows 98/Me/2000, click the "Start" button, select "Settings", and then click "Control Panel".

2 Click "Add or Remove Programs".

- In Windows Vista, click the "Uninstall a program".
- In Windows 98/Me/2000, double-click the "Add/Remove Programs" icon.

3 Select "SHARP AR-208 Series MFP Driver" and Button Manager from the list, and remove the software.

For more information, refer to your operating manual or to the help files for your operating system.

MISFEED REMOVAL

When a misfeed occurs, the error indicator blinks, "CLEAR PAPER JAM" appears in the display, and the machine stops operating. If a misfeed occurs when using the RSPF, "RETURN X ORIGINAL(S) START TO RESUME" will appear in the display. ("X" indicates the number of pages to be returned.) This indicates the number of the originals that must be returned to the document feeder tray after a misfeed. Return the required number of originals. This number will be cleared when copying is resumed or the [CLEAR] key () is pressed. If an original misfeed occurs in the RSPF, the machine will stop and the error indicator will blink. To remove a misfeed from the RSPF, see "D: Misfeed in the RSPF" (p.73).

- 1** Open the bypass tray, and then open the side cover.

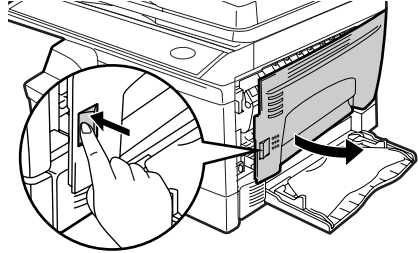

- 2** Check the misfeed location. Remove the misfed paper following the instructions for each location in the illustration below. If the error indicator blinks, proceed to "A: Misfeed in the paper feed area" (p.71).

If the misfed paper is seen from this side, proceed to "C: Misfeed in the transport area". (p.72)

If paper is misfed here, proceed to "B: Misfeed in the fusing area". (p.71)

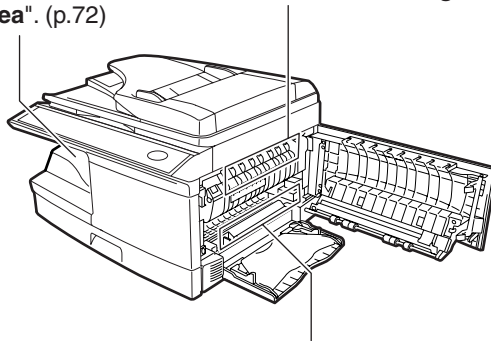

If paper is misfed here, proceed to "A: Misfeed in the paper feed area". (p.71)

A: Misfeed in the paper feed area

- 1** Gently remove the misfed paper from the paper feed area as shown in the illustration. If the error indicator blinks and the misfed paper is not visible in the paper feed area, pull out the paper tray and remove the misfed paper. If the paper cannot be removed, proceed to "B: Misfeed in the fusing area".



Warning The fusing unit is hot. Do not touch the fusing unit when removing misfed paper. Doing so may cause a burn or other injury.



- Do not touch the photoconductive drum (green portion) when removing the misfed paper. Doing so may damage the drum and cause smudges on copies.
- If the paper has been fed through the bypass tray, do not remove the misfed paper through the bypass tray. Toner on the paper may stain the paper transport area, resulting in smudges on copies.

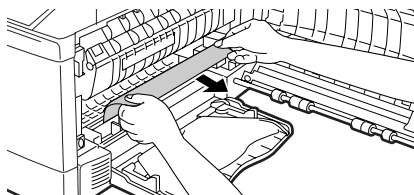

- 2** Close the side cover by pressing the round projections near the side cover open button. The error indicator will go out and the ready indicator will light up.

B: Misfeed in the fusing area

- 1** Lower the fusing unit release lever.

Fusing unit release lever

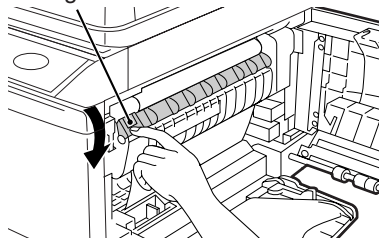

- 2 Gently remove the misfed paper from under the fusing unit as shown in the illustration. If the paper cannot be removed, proceed to "C: Misfeed in the transport area".**

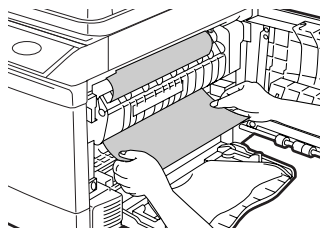

The fusing unit is hot. Do not touch the fusing unit when removing misfed paper. Doing so may cause a burn or other injury.



- Do not touch the photoconductive drum (green portion) when removing the misfed paper. Doing so may damage the drum and cause smudges on copies.
- Do not remove the misfed paper from above the fusing unit. Unfixed toner on the paper may stain the paper transport area, resulting in smudges on copies.

- 3 Raise the fusing unit release lever and then close the side cover by pressing the round projections near the side cover open button. The error indicator will go out and the ready indicator will light up.**

C: Misfeed in the transport area

- 1 Lower the fusing unit release lever.**

See "B: Misfeed in the fusing area" (p.71).

- 2 Open the front cover.**

To open the front cover, see "TONER CARTRIDGE REPLACEMENT" (p.74).

- 3 Rotate the roller rotating knob in the direction of the arrow and gently remove the misfed paper from the exit area.**

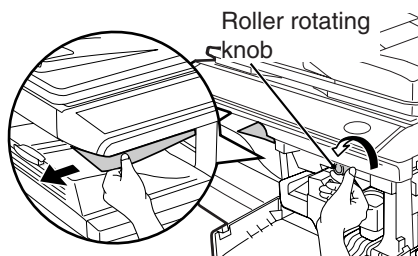

- 4** Raise the fusing unit release lever, close the front cover and then close the side cover by pressing the round projections near the side cover open button. The error indicator will go out and the ready indicator will light up.

**Caution**

When closing the covers, be sure to close the front cover securely and then close the side cover. If the covers are closed in the wrong order, the covers may be damaged.

D: Misfed in the RSPF

If the misfed original is at the top of the document feeder tray or in the exit area, follow procedure (A) to remove the misfed. If the misfed original is inside the document feeder and is not visible, follow procedure (B).

- (A)** If the misfed original is at the top of the document feeder tray or in the exit area, open the document feeder cover and pull out the original. If the original resists your pulling, press down on the RSPF jam release lever while pulling out the original. When finished, close the document feeder cover.

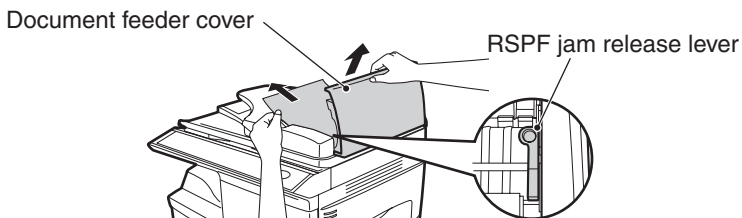

- (B)** Open the document feeder cover. Next, open the RSPF and rotate the roller in the direction of the arrow. If the misfed original is in the state (X), pull the original out as it feeds out into the exit area. If the misfed original is in the state (Y), pull the original down and out. When finished, lower the RSPF and close the document feeder cover.

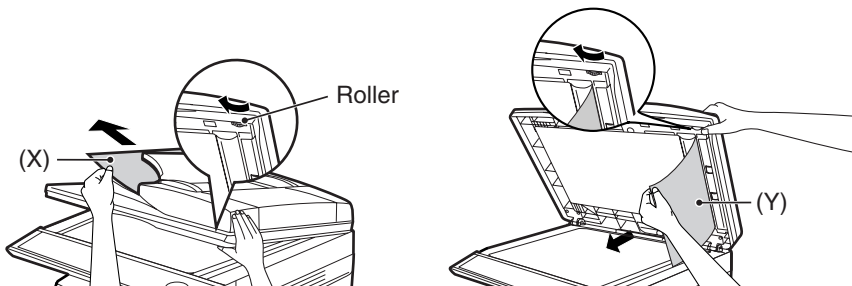
**Note**

Open and close the RSPF to clear the error indicator. "RETURN X ORIGINAL(S) START TO RESUME" will appear in the display. Return the indicated number of pages to the document feeder tray. Press the [START] key () to resume copying.

TONER CARTRIDGE REPLACEMENT

When toner is low, the error indicator will light up and "TONER CARTRIDGE IS NEAR EMPTY." will appear in the display to alert you to purchase a new toner cartridge. If copying is continued while the indicator is lit, copies will gradually become lighter until the toner runs out. When the toner runs out, the machine will stop operating, the error indicator will blink, and "REPLACE THE TONER CARTRIDGE" will appear in the display. Follow the procedure below to replace the toner cartridge.



- After the machine stops, it may be possible to make a few more copies by taking the toner cartridge out of the machine, shaking it horizontally, then reinstalling it. If copying is not possible after this operation, replace the toner cartridge.
- During a long copy run of a dark original, "TONER REPLENISHMENT IN PROGRESS" appears in the display, and the machine may stop even though toner is left. The machine will feed toner up to 2 minutes and then the ready indicator will light up. Press the [START] key () to resume copying.

-
- 1** Open the bypass tray, and then open the side cover while pressing the side cover open button.

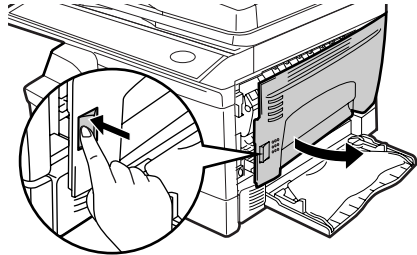

-
- 2** Push gently on both sides of the front cover to open the cover.

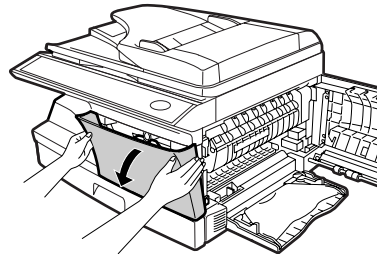

- 3 Gently pull the toner cartridge out while pressing the lock release lever.**

Toner cartridge lock release lever

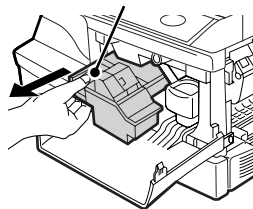

- After removing the toner cartridge, do not shake it or tap on it. Doing so may cause toner to leak from the cartridge. Put the old cartridge immediately in the bag contained in the box of the new cartridge.
- Dispose of the old toner cartridge in accordance with local regulations.

- 4 Remove the toner cartridge from the bag. Grasp the cartridge on both sides and shake it horizontally four or five times. After shaking the cartridge, remove the toner seal.**

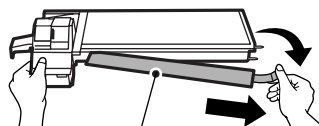
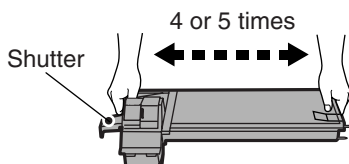

Toner seal



Grasp the toner cartridge as shown in the illustration. Do not hold the cartridge by the shutter. Be sure to only shake the cartridge before the toner seal is removed.

- 5 Gently insert the toner cartridge along the guides until it locks in place while pushing the lock release lever. Remove the tape from the shutter. Pull the shutter out of the toner cartridge as shown in the illustration. Discard the shutter.**

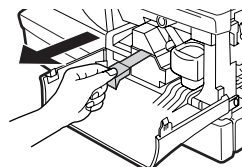
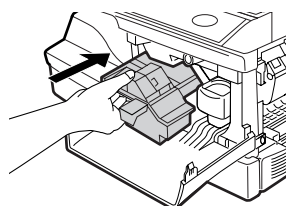

- 6** Close the front cover and then the side cover by pressing the round projections near the side cover open button. The error indicator will go out and the ready indicator will light up.

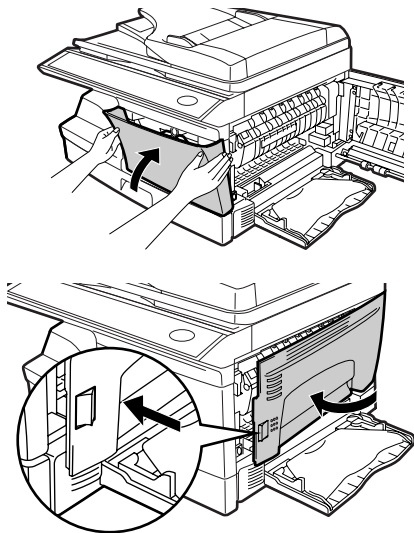

When closing the covers, be sure to close the front cover securely and then close the side cover. If the covers are closed in the wrong order, the covers may be damaged.



Even after a new toner cartridge is installed, the start (⊙) indicator may not light up, indicating copying cannot be restarted (toner is not sufficiently fed). In this case, open and close the side cover. The copier will feed toner again approximately 2 minutes and then copying can be restarted.

SCAN HEAD LOCKING SWITCH

The scan head locking switch is under the original table. If the switch is locked (🔒), the machine will not operate. Unlock the switch (🔓) as shown below.

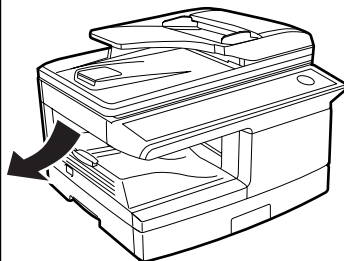
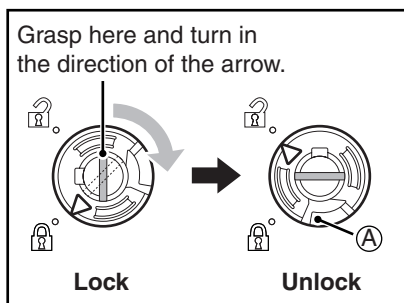

To lock the scan head locking switch, hold up the catch in illustration **A** and turn the center knob counter-clockwise 90 degrees until you hear a click.

CHECKING THE TOTAL COUNT

You can check the total number of pages output by the machine (all pages printed by the copy function and printer function), as well as the output counts of each function (number of copies, number of scanned pages, number of faxes, etc.). When a count reaches 999,999 it returns to 0.

- 1** Press the [MENU] key.
Press the [◀] key (▼) or [▶] key (▲)
until "TOTAL COUNT" appears, and then
press the [ENTER] key.

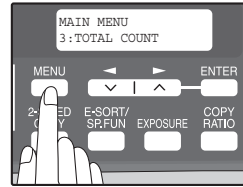

- 2** Press the [◀] key (▼) or [▶] key (▲) to
display the count of each function.

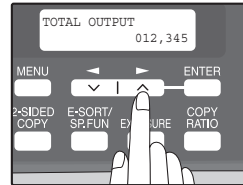

The count of each function changes as follows each the [◀] key (▼) or [▶] key (▲) is pressed:

- "TOTAL OUTPUT": Total number of pages output by the machine
- "COPIES": Total number of copies
- "SPF/RSPF": Total number of pages scanned using the RSPF
- "2-SIDED PRINT":*1 Total number of pages printed by two-sided print
- "PRINTS": Total number of pages printed the printer function
- "FAX":*2 Total number of sent and received faxes
- "FAX SEND":*2 Total number of sent faxes
- "SCAN SEND": Total number of scans
- "TONER REMAINING": The approximate amount of toner remaining in the toner cartridge is displayed as a percentage.

*1 AR-208D only

*2 When the optional Facsimile Expansion Kit is installed.

MAINTENANCE REQUIRED

When the error indicator will blink and "MAINTENANCE REQUIRED CALL FOR SERVICE" will appear in the display, service by an authorized SHARP service technician is required. Contact your service center as soon as possible.

CLEANING THE MACHINE

Proper care is essential in order to get clean, sharp copies. Be sure to take a few minutes to clean the machine on a regular basis.



Do not spray flammable cleaner gas. Gas from the spray may come in contact with the internal electrical components or high-temperature parts of the fusing unit, creating a risk of fire or electrical shock.



- Before cleaning, be sure to turn the power switch off and remove the power cord from the outlet.
- Do not use thinner, benzene or other volatile cleaning agents. Doing so may cause deformation, discoloration, deterioration or malfunction.

Cabinet

Wipe the cabinet with a soft, clean cloth.

Document glass and the back side of the RSPF

Stains on the glass, RSPF scanning window, cover or RSPF roller will also be copied. Wipe the glass, RSPF scanning window, cover and RSPF roller with a soft, clean cloth. If necessary, dampen the cloth with a glass cleaner.

Document glass/scanning window

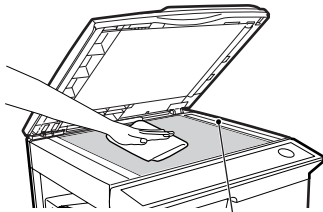

RSPF scanning window

RSPF

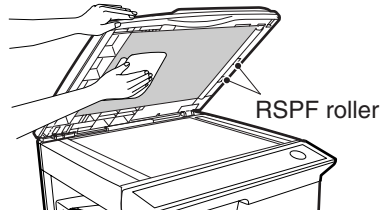

RSPF roller

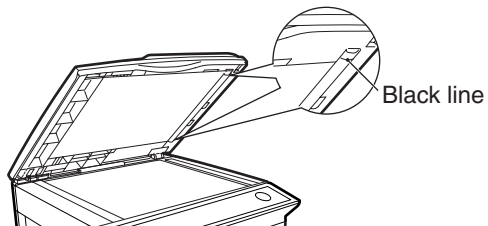

If this area is dirty, copying from the RSPF will not be possible.

Transfer charger

- 1** Turn the power switch off. (p.13)
- 2** Ensure that the bypass tray is open and then open the side cover while pressing the side cover open button.
- 3** Take the charger cleaner out by holding the tab. Set the charger cleaner onto the right end of the transfer charger, gently slide the cleaner to the left end, and then remove it. Repeat this operation two or three times.



Note

Slide the charger cleaner from the right end to the left end along the groove of the transfer charger. If the cleaner is stopped on the way, smudges on copies may occur.

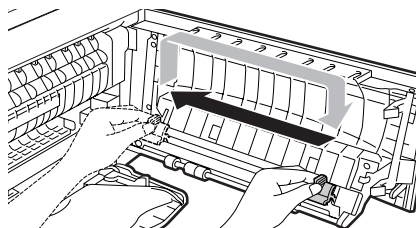
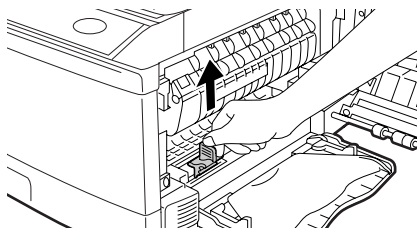

- 4** Return the charger cleaner to its original position. Close the side cover by pressing the round projections near the side cover open button.

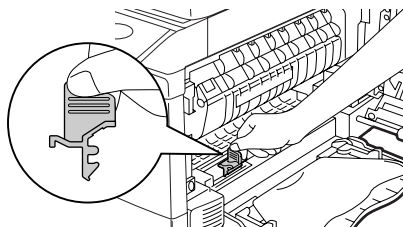

- 5** Turn the power switch on. (p.12)

SYSTEM CONFIGURATION

A number of options are available for the unit which allow you to configure a system to meet your particular needs. The options include the following.



Be sure to use only genuine SHARP parts and supplies.



For best copying results, be sure to use only SHARP Genuine Supplies which are designed, engineered and tested to maximize the life and performance of SHARP copiers. Look for the Genuine Supplies label on the toner package.

**Facsimile
Expansion Kit
(AR-FX13)**

**Network
Expansion Kit
(AR-NB2 A)**



**250-sheet paper
feed unit (AR-D33)**

FACSIMILE EXPANSION KIT (AR-FX13)

This allows the machine to be used as a facsimile machine.

NETWORK EXPANSION KIT (AR-NB2 A)

This allows the machine to be used as a network printer/network scanner.

PS3 EXPANSION KIT (AR-PK1N)

This allows the machine to be used as a Postscript compatible printer.

250-SHEET PAPER FEED UNIT (AR-D33)

The paper feed unit provide the convenience of increased paper capacity for the unit and a greater choice of paper size readily available for copying.

The procedures for loading paper in the paper tray of paper feed unit, changing the paper size, and selecting the paper tray are same as for the paper tray in the unit. See "LOADING THE PAPER TRAY" (p.15) and "SELECTING THE TRAY" (p.23).

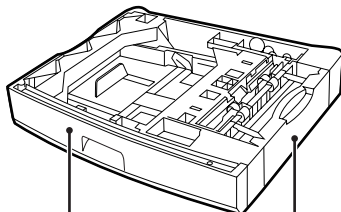

Tray

Lower side cover

Using the AR-D33 with the printer function

To use the AR-D33 with the printer function, follow these steps to adjust the settings in the printer driver.



The printer driver cannot be set for use with the AR-D33 when opened from the application.

1 Click the "start" button.

2 Click "Control Panel", select "Printer and Other Hardware", and then click "Printer and Faxes".

- In Windows Vista, click "Control Panel", and then click "Printer".
- In Windows 98/Me/2000, select "Setting" and click "Printers".

3 Click the "SHARP AR-XXXX" printer driver icon and from the "File" menu select "Properties".

- In Windows Vista, from the "Organize" menu select "Properties".
- In Windows 98/Me, click the "SHARP AR-XXXX" printer driver icon, select "Properties" from the "File" menu, and then click the "Setup" tab.

4 Click the "Configuration" tab.

5 Select "Two trays" for "Input tray option", and click "OK".

The printer driver closes. This completes the settings needed to use the AR-D33.

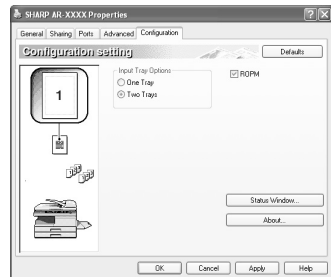

Interface cable

Please purchase the appropriate cable for your computer.

USB interface cable

USB cable that supports USB 2.0.

SPECIFICATIONS

Model	AR-208S	AR-208D
Type	Digital Multifunctional System, Desktop	
Photoconductive type	OPC drum	
Document glass type	Fixed	
Copy/printing system	Dry, electrostatic transfer	
Originals	Sheets, bound documents	
Originals size	Max. 8-1/2" x 14"	
Copy size	Max. 8-1/2" x 14" Min. 3-1/2" x 5-1/2" Image loss: Max. 11/64" (4 mm) (leading and trailing edges) Max. 3/16" (4.5 mm) (along other edges in total)	
Copying speed*1	20 copies/min. (8-1/2" x 11", one-sided copying at 100% copy ratio)	
Continuous copy	Max. 99 copies; subtractive counter	
First-copy time*2	8.0 seconds (When user program 24 is set to OFF) 10.7 seconds (When user program 24 is set to ON) (paper: 8-1/2" x 11", exposure mode: AUTO, copy ratio: 100%)	
Warm-up time*3	Approx. 0 sec.	
Copy ratio	Document glass: Variable: 25% to 400% in 1% increments (total 376 steps) Fixed preset: 25%, 50%, 64%, 78%, 100%, 129%, 200%, 400% RSPF: Variable: 50% to 200% in 1% increments (total 151 steps) Fixed preset: 50%, 64%, 78%, 100%, 129%, 200%	
Exposure system	Document glass: Moving optical source, slit exposure (stationary platen) with automatic exposure function RSPF: Moving original	
Paper feed	One automatic feeding paper tray (250 sheets) + bypass tray (50 sheets)	

Fusing system	Heat rollers	
Developer system	Magnetic brush development	
Light source	Cold cathode fluorescent lamp (CCD: 3 components; R, G, and B)	
Resolution	Scan: 600 x 300 dpi Output: 600 x 600 dpi(AUTO/TEXT mode) Scan: 600 x 600 dpi Output: 600 x 600 dpi(PHOTO mode)	
Gradation	256 tones (8 bits)	
Power supply	120 V, 60 Hz, 8.0 A	
Power consumption	Max. 1.0 kW	
Space requirements (with trays extended)	31.6" (W) x 17.6" (D) (802 mm (W) x 445 mm (D))	
Weight^{*4}	Approx. 43.9 lbs. (19.9 kg)	Approx. 45.4 lbs. (20.6 kg)
Dimensions	20.4" (W) x 17.6" (D) x 14.6" (H) (518 mm (W) x 445 mm (D) x 371 mm (H))	
Operating conditions	Temperature: 50°F to 86°F (10°C to 30°C) Humidity: 20% to 85%	
Noise level	Sound Power Level LwA(1B=10dB) Copying: 6.2[B] Standby: 3.2[B] Sound Pressure Level LpA (bystander positions) Copying: 48[dB(A)] Standby: 17[dB(A)] Sound Pressure Level LpA (operator position) Copying: 52[dB(A)] Standby: 17[dB(A)] Noise emission measurement in accordance with ISO 7779.	
Emission concentration (measured according to RAL-UZ62 : Edition Jan. 2002)	Ozone: 0.02 mg/m ³ or less Dust: 0.075 mg/m ³ or less Styrene: 0.07 mg/m ³ or less	

*1 When making multiple duplex copies, the copy speed will vary based on the environment conditions.

*2 The first-copy time is measured after the power save indicator turns off following power on, using the document glass with the polygon rotating in the copy ready state and "LSU SETTING" set to ON in the user programs (8-1/2" x 11", paper fed from paper tray).

The first-copy time may vary depending on machine operating conditions and ambient conditions such as temperature.

The time from power off until the first copy is output varies depending on the installation site and the state of the machine in use.

*3 The warm-up time may vary depending on machine operating conditions and ambient conditions such as temperature.

*4 Not including toner cartridges.

Printer Function

Print speed*	20 ppm
Resolution	600 dpi
Memory	Approx. 30 MB
Emulation	SPLC (Sharp Printer Language with Compression)
Interface	USB 2.0 (Full-Speed/Hi-Speed compatible interface)
Interface cables	[USB cable] USB cable that supports USB 2.0. Please purchase a commercially available USB cable.

* When printing same document continuously on 8-1/2" x 11" plain paper in non-offset mode, excluding processing time.

Scanner Function

Type	Flatbed scanner
Scanning method	Document glass/RSPF
Light source	Cold cathode fluorescent lamp (CCD: 3 components; R, G, and B)
Resolution	Basic: 600 dpi x 1200 dpi Setting range: 50dpi - 9600dpi
Original types	Sheet media, books
Effective scanning area	8.5" (216 mm) (Lengthwise) x 14" (356 mm) (Width)
Scanning speed	2.88 msec/line
Input Data	1 bit or 12 bit
Output Data	R.G.B 1 or 8 bits / pixel / A/D 16 bit
Scanning colors	Black and white 2 value, Grayscale, Full color
Protocol	TWAIN WIA (Windows XP/Vista only) STI
Interface	USB 2.0 (Full-Speed/Hi-Speed compatible interface)
Drop out color	Yes
Supported operating systems	Windows 98/Me/2000 Professional/XP/Vista (Detailed information can be found in "BEFORE INSTALLATION" (p.37))
Void area	None
Interface cables	[USB cable] USB cable that supports USB 2.0. Please purchase a commercially available USB cable.
Scanner utilities	Button Manager / Sharpdesk

250-sheet paper feed unit (AR-D33)

Paper size	5-1/2" x 8-1/2" to 8-1/2" x 14"
Paper weight	15 lbs. to 21 lbs. (56g/m ² to 80g/m ²)
Paper capacity	One paper tray with capacity for 250 sheets of 21 lbs. bond paper
Weight	6.6 lbs. (3kg)
Dimensions	19.5" (W) x 15.6" (D) x 3.5" (H) (495mm (W) x 395mm (D) x 88mm (H))
Power supply	Drawn from the unit



As a part of our policy of continuous improvement, SHARP reserves the right to make design and specification changes for product improvement without prior notice. The performance specification figures indicated are nominal values of production units. There may be some deviations from these values in individual units.

Date Issued : Nov. 1, 2007
MSDS No. F-01601

1.PRODUCT AND COMPANY IDENTIFICATION

Product Name : AR-208NT/ AR-208T (Black Toner)

Supplier Identification : Sharp Corporation
22-22 Nagaïke-cho, Abeno-ku, Osaka, Japan

Local suppliers are listed below. Please contact the nearest supplier for additional information.

Area	(Country)	(Name and Telephone Number)
North America	U.S.A.	Sharp Electronics Corporation Sharp Plaza, Mahwah, NJ Telephone number for information : 1-800-237-4277 Emergency telephone number : 1-800-255-3924
	Canada	Sharp Electronics of Canada Ltd. Telephone number for information : 905-890-2100 Emergency telephone number : 1-800-255-3924
Oceania	Australia	Sharp Corporation of Australia PTY. Ltd. No1 Huntingwood Drive Huntingwood Blacktown N.S.W. Telephone number for information : 1300-13-50-22
Europe	Germany	Sharp Electronics (Europe) GMBH Sonninstrasse 3, 20097 Hamburg Telephone number to access MSDS : 040-2376-2185 For more information : 040-2376-2613
	United Kingdom	Sharp Electronics (U. K.) Ltd. Telephone number for information : 08705-274-277
	France	Sharp Electronics France S.A. Telephone number for information : 01-49-90-34-00
	Austria	Sharp Electronics GMBH Telephone number for information : 01-727-19-0
	Italy	Sharp Electronics (Italy) S.P.A. Telephone number for information : 02895951
	Spain	Sharp Electronics (España) S.A. Telephone number for information : 93-581-97-00
	Netherlands	Sharp Electronics Benelux B.V. Telephone number for information : 30-6359500
	Sweden	Sharp Electronics Nordic AB Telephone number for information : 08-634-36-00
Middle East	U.A.E.	Sharp Electronics (Schweiz)AG Telephone number for information : 01-846-6111
		Sharp Middle East FZE P.O.Box 17115 Jebel Ali, Dubai Telephone number for information : 04-815311

2.COMPOSITION / INFORMATION ON INGREDIENTS

Substance[]	Preparation[X]					
Ingredient	CAS No.	Proportion	OSHA PEL	ACGIH TLV	MAK-TWA	NOHSC-TWA
Styrene-Acrylate copolymer	29497-14-1	85-95%	Not listed	Not listed	Not listed	Not listed
Carbon black	1333-86-4	5-10%	3.5mg/m ³	3.5mg/m ³	Not listed	3mg/m ³
Iron oxide	1309-38-2	1-5%	Not listed	Not listed	Not listed	Not listed
Metal Complex dye*	109125-51-1 84179-66-8	< 2%	0.5mg/m ³	0.5mg/m ³	Not listed	Not listed

* EC NO. : 400-110-2, Symbol letter : F,N , R Phrase : R11, R50/53

Date Issued : Nov. 1, 2007
MSDS No. F-01601

3.HAZARDS IDENTIFICATION

Most Important Hazards and Effects of the Products

Human Health Effects : There are no anticipated carcinogenic effects from exposure based on animal tests performed using toner. When used as intended according to instructions, studies do not indicate any symptoms of fibrosis will occur.

Environmental Effects : Not toxic to aquatic organisms
[Estimated from the other product containing similar material]

Specific Hazards : Dust explosion (like most finely divided organic powders)

Directive 1999/45/EC(Europe) : Not classified as dangerous

4.FIRST-AID MEASURES

Route(s) of Entry :	<u>Inhalation?</u>	<u>Skin?</u>	<u>Ingestion?</u>
	Yes	No	Possible but very unusual.

Inhalation : Remove to fresh air. If symptoms occur, consult medical personnel.

Skin Contact : Wash with soap and water for 15 minutes or until particle is removed.
If irritation does occur, consult medical personnel.

Eye Contact : Flush eyes immediately with water for 15 minutes. If irritation does occur, consult medical personnel.

Ingestion : Rinse with water and drink several glasses of water. If irritation or discomfort does occur, consult medical personnel.

5.FIRE-FIGHTING MEASURES

Extinguishing Media : Water, CO₂, foam and dry chemicals

Special Fire Fighting Procedures : None

Fire and Explosion Hazards : Toner material, like most finely divided organic powders, may form an explosive mixture.

6.ACCIDENTAL RELEASE MEASURES

Personal Precautions : None

Environmental Precautions : None

Methods for Cleaning Up : Wipe off with paper or cloth. Do not use vacuum cleaner when a large amount is released. It, like most finely divided organic powders, is capable of creating a dust explosion.

7.HANDLING AND STORAGE

Handling

Technical Measures : None

Precautions : None

Safe Handling Advice : Use of a dust mask is recommended when handling a large quantity of toner or during long term exposure, as with any non-toxic dust. Try not to disperse the particles.

Storage

Technical Measures : None

Storage Conditions : Keep container closed and Store in a cool and dry place.

Keep out of the reach of children.

Incompatible Products : None

Date Issued : Nov. 1, 2007
MSDS No. F-01601

8.EXPOSURE CONTROLS / PERSONAL PROTECTION

Engineering Measures

Ventilation : Not required under intended use.

Exposure Limit Values

OSHA-PEL(USA) : 15mg/m³ (Total Dust), 5mg/m³ (Respirable Dust)

ACGIH-TLV(USA) : 10mg/m³ (Total Dust), 3mg/m³ (Respirable Dust)

Personal Protective Equipment

Respiratory Protection : Not required under intended use.

Hand Protection : Not required under intended use.

Eye Protection : Not required under intended use.

Skin Protection : Not required under intended use.

Other Protective Equipment : Use of a dust mask and goggles are recommended when handling a large quantity of toner or during long term exposure, as with any non-toxic dust.

9.PHYSICAL AND CHEMICAL PROPERTIES

Appearance

Physical State : Solid Form : Powder Color : Black Odor : odorless

Ph : Not applicable

Boiling / Melting Point : Not applicable

Softening Point(°C) : 100 - 130

Flash Point(°C) : Not applicable

Ignition Point(°C) : > 350

Explosion Properties : No data

Density(g/cm³) : 1.1 (bulk density : 0.35)

Solubility in Water : Negligible

10.STABILITY AND REACTIVITY

Stability : Stable

Hazardous Reactions : Dust explosion, like most finely divided organic powders.

Conditions to Avoid : Electric discharge, throwing into fire.

Materials to Avoid : Oxidizing Materials

Hazardous Decomposition Products : CO, CO₂ and NO_x

Further Information : None

11.TOXICOLOGICAL INFORMATION

Acute Toxicity

Ingestion(oral) : LD₅₀ > 2500mg/kg [Estimated from the other product containing similar material]

Inhalation : No data

Eye irritation : Not an irritant [Estimated from the other product containing similar material]

Skin irritation : Not an irritant [Estimated from the other product containing similar material]

Skin sensitizer : No sensitized [Estimated from the other product containing similar material]

Mutagenicity : Negative (Ames Test) [Estimated from the other product containing similar material]

Carcinogenicity : In 1996 the IARC reevaluated carbon black as a Group 2B carcinogen (possible human carcinogen). This classification is given to chemicals for which there is inadequate human evidence, but sufficient animal evidence on which to base an opinion of carcinogenicity. The classification is based upon the development of lung tumors in rats receiving chronic inhalation exposures to free carbon black at levels that induce particle overload of the lung. Studies performed in animal models other than rats did not show any association between carbon black and lung tumors. Moreover, a two-year cancer bioassay using a typical toner preparation containing carbon black demonstrated no association between toner exposure and tumor development in rats.

Date Issued : Nov. 1, 2007
MSDS No. F-01601

Chronic Effect : In a study in rats of chronic inhalation exposure to a typical toner, a mild to moderate degree of lung fibrosis was observed in 92% of the rats in the high concentration (16mg/m³) exposure group, and a minimal to mild degree of fibrosis was noted in 22% of the animals in the middle (4mg/m³) exposure group, but no pulmonary change was reported in the lowest (1mg/m³) exposure group, the most relevant level to potential human exposures.

12.ECOLOGICAL INFORMATION

Ecotoxicity : On available data, toner is not harmful to aquatic organisms
[Estimated from the other product containing similar material]

13.DISPOSAL CONSIDERATIONS

Waste from Residues : Waste material may be dumped or incinerated under conditions which meet all federal, state and local environmental regulations.

Contaminated Packaging : Waste may be disposed or incinerated under conditions which meet all federal, state and local environmental regulations.

14.TRANSPORT INFORMATION

UN Classification : None
Not classified as hazardous for transport.

15.REGULATORY INFORMATION

US Information

TSCA(Toxic Substances Control Act) :

All chemical substances in this product comply with all applicable rules or order under TSCA.

SARA(Superfund Amendments and Reauthorization Act) Title III

302 Extreme Hazardous Substance : None

311/312 Hazard Classification : None

EU Information

1999/45/EC and 67/548/EEC

Symbol & Indication : Not required

R-Phrase : Not required

76/769/EEC : All chemical substances in this product comply with all applicable rules or order under 76/769/EEC.

16.OTHER INFORMATION

NFPA Rating (USA) : Health=1 Flammability=1 Reactivity=0

WHMIS Legislation (Canada) : This product is not a controlled product.

List of R phrases : R11 : Highly flammable

R50/53 : Very toxic to aquatic organisms, may cause long-term adverse effects in the aquatic environment.

References

IARC(1996) : IARC monographs on the Evaluation of the Carcinogenic Risk of Chemicals to Humans, Vol. 65, Printing Process And Printing Inks, Carbon Black and Some Nitro Compounds, Lyon, pp.149-261

H.Muhle, B.Bellmann, O.Creutzenberg, C.Dasenbrock, H.Ernst, R.Kilpper, J.C.MacKenzie, P.Morrow, U.Mohr, S.Takenaka, and R.Mermelstein(1991) Pulmonary Response to Toner upon Chronic Inhalation Exposure in Rats. Fundamental and Applied Toxicology 17, pp.280-299.

The information on this data sheet represents our current data and best opinion as to the proper use in handling of this product under normal conditions. However, all materials may present unknown hazards and should be used with caution. Although certain hazards are described herein, we do not guarantee that these are the only hazards which exist.

Date Issued : Nov.01, 2007
 MSDS No. F-31601

1.PRODUCT AND COMPANY IDENTIFICATION

Product Name : AR-208ND / AR-208DV (Black Developer)
Supplier Identification : Sharp Corporation
 22-22 Nagaike-cho, Abeno-ku, Osaka, Japan

Local suppliers are listed below. Please contact the nearest supplier for additional information.

Area	(Country)	(Name and Telephone Number)
North America	U.S.A.	Sharp Electronics Corporation Sharp Plaza, Mahwah, NJ Telephone number for information : 1-800-237-4277 Emergency telephone number : 1-800-255-3924
	Canada	Sharp Electronics of Canada Ltd. Telephone number for information : 905-890-2100 Emergency telephone number : 1-800-255-3924
Oceania	Australia	Sharp Corporation of Australia PTY. Ltd. No1 Huntingwood Drive Huntingwood Blacktown N.S.W. Telephone number for information : 1300-13-50-22
Europe	Germany	Sharp Electronics (Europe) GMBH Sonninstrasse 3, 20097 Hamburg Telephone number to access MSDS : 040-2376-2185 For more information : 040-2376-2613
	United Kingdom	Sharp Electronics (U. K.) Ltd. Telephone number for information : 08705-274-277
	France	Sharp Electronics France S.A. Telephone number for information : 01-49-90-34-00
	Austria	Sharp Electronics GMBH Telephone number for information : 01-727-19-0
	Italy	Sharp Electronics (Italy) S.P.A. Telephone number for information : 02895951
	Spain	Sharp Electronics (Espana) S.A. Telephone number for information : 93-581-97-00
	Netherlands	Sharp Electronics Benelux B.V. Telephone number for information : 30-6359500
	Sweden	Sharp Electronics Nordic AB Telephone number for information : 08-634-36-00
Middle East	Switzerland	Sharp Electronics(Schweiz)AG Telephone number for information : 01-846-6111
	U.A.E.	Sharp Middle East FZE P.O.Box 17115 Jebel Ali, Dubai Telephone number for information : 04-815311

2.COMPOSITION / INFORMATION ON INGREDIENTS

Substance[]	Preparation[X]					
<u>Ingredient</u>	<u>CAS No.</u>	<u>Proportion</u>	<u>OSHA PEL</u>	<u>ACGIH TLV</u>	<u>MAK-TWA</u>	<u>NOHSC-TWA</u>
Iron powder	7439-89-6	85-95 %	Not listed	Not listed	Not listed	Not listed
Styrene-Acrylate copolymer	29497-14-1	5-10 %	Not listed	Not listed	Not listed	Not listed
Carbon black	1333-86-4	< 1 %	3.5mg/m ³	3.5mg/m ³	Not listed	3mg/m ³

Date Issued : Nov.01, 2007
MSDS No. F-31601

3.HAZARDS IDENTIFICATION

Most Important Hazards and Effects of the Products

Human Health Effects : There are no anticipated carcinogenic effects from exposure based on animal tests performed using toner. When used as intended according to instructions, studies do not indicate any symptoms of fibrosis will occur.

Environmental Effects : Not toxic to aquatic organisms
[Estimated from the other product containing similar material]

Specific Hazards : Dust explosion (like most finely divided organic powders)

Directive 1999/45/EC(Europe) : Not classified as dangerous

4.FIRST-AID MEASURES

Route(s) of Entry :	<u>Inhalation?</u>	<u>Skin?</u>	<u>Ingestion?</u>
	No	No	Possible but very unusual.

Inhalation : Remove to fresh air. If symptoms occur, consult medical personnel.

Skin Contact : Wash with soap and water for 15 minutes or until particle is removed.
If irritation does occur, consult medical personnel.

Eye Contact : Flush eyes immediately with water for 15 minutes. If irritation does occur, consult medical personnel.

Ingestion : Rinse with water and drink several glasses of water. If irritation or discomfort does occur, consult medical personnel.

5.FIRE-FIGHTING MEASURES

Extinguishing Media : Water, CO₂, foam and dry chemicals

Special Fire Fighting Procedures : None

Fire and Explosion Hazards : Toner material, like most finely divided organic powders, may form an explosive mixture.

6.ACCIDENTAL RELEASE MEASURES

Personal Precautions : None

Environmental Precautions : None

Methods for Cleaning Up : Wipe off with paper or cloth. Do not use vacuum cleaner when a large amount is released. It, like most finely divided organic powders, is capable of creating a dust explosion.

7.HANDLING AND STORAGE

Handling

Technical Measures : None

Precautions : None

Safe Handling Advice : Use of a dust mask is recommended when handling a large quantity of toner or during long term exposure, as with any non-toxic dust. Try not to disperse the particles.

Storage

Technical Measures : None

Storage Conditions : Keep container closed and Store in a cool and dry place.
Keep out of the reach of children.

Incompatible Products : None

Date Issued : Nov.01, 2007
MSDS No. F-31601

8.EXPOSURE CONTROLS / PERSONAL PROTECTION

Engineering Measures

Ventilation : Not required under intended use.

Exposure Limit Values

OSHA-PEL(USA) : 15mg/m³ (Total Dust), 5mg/m³ (Respirable Dust)

ACGIH-TLV(USA) : 10mg/m³ (Total Dust), 3mg/m³ (Respirable Dust)

Personal Protective Equipment

Respiratory Protection : Not required under intended use.

Hand Protection : Not required under intended use.

Eye Protection : Not required under intended use.

Skin Protection : Not required under intended use.

Other Protective Equipment : Use of a dust mask and goggles are recommended when handling a large quantity of toner or during long term exposure, as with any non-toxic dust.

9.PHYSICAL AND CHEMICAL PROPERTIES

Appearance

Physical State : Solid Form : Powder Color : Black Odor : odorless

Ph : Not applicable

Boiling / Melting Point : Not applicable

Flash Point(°C) : Not applicable

Ignition Point(°C) : No data

Explosion Properties : No data

Density(g/cm³) : 7.3 (bulk density : 2.0)

Solubility in Water : Negligible

10.STABILITY AND REACTIVITY

Stability : Stable

Hazardous Reactions : Dust explosion, like most finely divided organic powders.

Conditions to Avoid : Electric discharge, throwing into fire.

Materials to Avoid : Oxidizing Materials

Hazardous Decomposition Products : CO, CO₂ and NO_x

Further Information : None

11.TOXICOLOGICAL INFORMATION

Acute Toxicity

Ingestion(oral) : LD₅₀ > 2000mg/kg [Estimated from the other product containing similar material]

Inhalation : No data

Eye irritation : Not an irritant [Estimated from the other product containing similar material]

Skin irritation : Not an irritant [Estimated from the other product containing similar material]

Skin sensitizer : No sensitized [Estimated from the other product containing similar material]

Mutagenicity : Negative (Ames Test) [Estimated from the other product containing similar material]

Carcinogenicity : In 1996 the IARC reevaluated carbon black as a Group 2B carcinogen (possible human carcinogen). This classification is given to chemicals for which there is inadequate human evidence, but sufficient animal evidence on which to base an opinion of carcinogenicity. The classification is based upon the development of lung tumors in rats receiving chronic inhalation exposures to free carbon black at levels that induce particle overload of the lung. Studies performed in animal models other than rats did not show any association between carbon black and lung tumors. Moreover, a two-year cancer bioassay using a typical toner preparation containing carbon black demonstrated no association between toner exposure and tumor development in rats.

Date Issued : Nov.01, 2007
MSDS No. F-31601

Chronic Effect : In a study in rats of chronic inhalation exposure to a typical toner, a mild to moderate degree of lung fibrosis was observed in 92% of the rats in the high concentration (16mg/m³) exposure group, and a minimal to mild degree of fibrosis was noted in 22% of the animals in the middle (4mg/m³) exposure group, but no pulmonary change was reported in the lowest (1mg/m³) exposure group, the most relevant level to potential human exposures.

12.ECOLOGICAL INFORMATION

Ecotoxicity : On available data, toner is not harmful to aquatic organisms
[Estimated from the other product containing similar material]

13.DISPOSAL CONSIDERATIONS

Waste from Residues : Waste material may be dumped or incinerated under conditions which meet all federal, state and local environmental regulations.

Contaminated Packaging : Waste may be disposed or incinerated under conditions which meet all federal, state and local environmental regulations.

14.TRANSPORT INFORMATION

UN Classification : None
Not classified as hazardous for transport.

15.REGULATORY INFORMATION

US Information

TSCA(Toxic Substances Control Act) :

All chemical substances in this product comply with all applicable rules or order under TSCA.

SARA(Superfund Amendments and Reauthorization Act) Title III

302 Extreme Hazardous Substance : None

311/312 Hazard Classification : None

EU Information

1999/45/EC and 67/548/EEC

Symbol & Indication : Not required

R-Phrase : Not required

76/769/EEC : All chemical substances in this product comply with all applicable rules or order under 76/769/EEC.

16.OTHER INFORMATION

NFPA Rating (USA) : Health=1 Flammability=1 Reactivity=0

WHMIS Legislation (Canada) : This product is not a controlled product.

References

IARC(1996) : IARC monographs on the Evaluation of the Carcinogenic Risk of Chemicals to Humans, Vol. 65, Printing Process And Printing Inks, Carbon Black and Some Nitro Compounds, Lyon, pp.149-261

H.Muhle, B.Bellmann, O.Creutzenberg, C.Dasenbrock, H.Ernst, R.Kilpper, J.C.MacKenzie, P.Morrow, U.Mohr, S.Takenaka, and R.Mermelstein(1991) Pulmonary Response to Toner upon Chronic Inhalation Exposure in Rats. Fundamental and Applied Toxicology 17, pp.280-299.

The information on this data sheet represents our current data and best opinion as to the proper use in handling of this product under normal conditions. However, all materials may present unknown hazards and should be used with caution. Although certain hazards are described herein, we do not guarantee that these are the only hazards which exist.

INDEX

Symbols

[#] key.....	10, 27, 29, 32
[◀] key	10
[▶] key	10

2

2 IN 1 copy	31
250-sheet paper feed unit	80, 86
[2-SIDED COPY] key	10, 27, 28
[2-SIDED SCAN] key.....	10, 28

A

About the operation manuals	6
Appendix	82
Audible signals	60
Auto clear	12
Auto power shut-off mode	13
Automatic two-sided copying.....	26

B

Basic procedure for printing	50
Before installation.....	37
Button Manager.....	36
Bypass feed.....	17
Bypass tray.....	9, 17, 18, 70, 74
Bypass tray paper guides.....	9, 18

C

Canceling a print job.....	50
Capacity of paper output tray	22
Caution	
- Handling the machine.....	4
- Label on the machine.....	3
- Selecting an installation site	3
- Using the machine.....	3
Changing a tray's paper size setting.....	19
Charger cleaner.....	9, 79
Checking the total count.....	77
Cleaning the machine	
- Cabinet.....	78
- Document glass.....	78
- RSPF.....	78
- RSPF scanning window	78
- Transfer charger.....	79
[CLEAR ALL] key	11, 12, 50

[CLEAR] key	
.....	10, 20, 21, 23, 29, 30, 50, 70
Connecting the machine to your computer	
- USB cable	42
Convenient copy functions	26
Conventions used in this manual and online manual	6
[COPY RATIO] key.....	11, 25

D

Display.....	10
Display messages	61
Document feeder cover	9, 73
Document feeder tray.....	9, 21
Document glass.....	9, 31

E

[ENTER] key.....	10
Envelopes.....	17
Environmental information.....	4
Error indicator.....	10, 61, 70
[E-SORT/SP.FUN] key	
.....	10, 29, 30, 31, 33, 34
Exit area	9
[EXPOSURE] key.....	10, 24
Exposure value guidelines	24

F

Facsimile expansion kit	80
Front cover	9, 72, 74
Fusing unit release lever	9, 71, 72

H

Handles	9
Hardware and software requirements	37
How to place the original.....	20
How to use the online manual	53

I		O	
Initial settings.....	12	Offset function during sort copy.....	30
Installing the software.....	36	Operation in copy, printer, and scanner modes.....	52
Interface cable.....	81	Operation panel.....	9, 10
Introduction.....	6	Optional equipment	80
L		Original guides	9, 21
Language setting.....	12	Original output tray extension.....	9, 22
Loading paper	14	Original types	24
Loading paper in the bypass tray	18	P	
Loading the paper tray	15	Paper.....	14
Long edge	26	Paper holder arm.....	9, 22
M		Paper output tray.....	9
Main features.....	7	Paper output tray extension	9, 22
Maintenance.....	61	Paper tray.....	9, 15
Maintenance required.....	77	Part names	9
Making copies	20	Photoconductive drum.....	9
Margin shift.....	34	Plug and play screen does not appear	68
Margin width	56	Power cord	9
[MENU] key	10	Power off	13
MFP driver.....	36	Power on	12
Misfeed removal		Power save indicator.....	10
- Fusing area	71	Power save modes.....	13
- Paper feed area.....	71	Power switch	9, 12, 13
- RSPF.....	73	Preheat mode.....	13
- Transport area.....	72	Preparations	9
Mode indicators	10	Printer driver.....	36
[MODE SELECT] key	10	Printer/scanner functions.....	49
N		Problems during setup of the software.....	67
Network expansion kit	80		
Normal copying			
- Document glass.....	20		
- RSPF.....	21		
Numeric keys.....	10, 23		

R

Ready indicator	11, 12, 76
Reduction/enlargement/zoom	25
Removing the software.....	69
Roller rotating knob	72
RSPF	9
RSPF indicator	10

S

Scan head locking switch	76
Scanner driver	36
Scanning from the operation panel ..	51
Scanning from your computer	52
Selecting a setting for a user program	59
Selecting the tray.....	23
Setting the number of copies.....	23
Setting up button manager	45
Sharpdesk	36
Short edge	26
Side cover	9, 70, 74
Side cover open button	9
Sort copy	29
Special papers.....	15
Specifications	82
[START] key	11, 20, 21
System configuration	80
System requirements for USB 2.0....	49

T

Toner cartridge	9, 74
Toner cartridge lock release lever	75
Toner cartridge replacement	74
Transfer charger.....	9
Tray location indicator	10, 61
[TRAY SELECT] key	10, 18, 23
Troubleshooting.....	61

U

USB connector	9, 42
User programs	
- Copy mode	54
- Print mode	58
User settings	54
Using the manual	6
Using the printer mode	50
Using the scanner mode	51

INDEX BY PURPOSE

Preparations

Paper, loading	
- Bypass tray.....	17
- Paper tray.....	15
Power, turn off.....	13
Power, turn on.....	12
Scan head locking switch, releasing.....	76
Tray's paper size, setting.....	19
User program, setting.....	54

Making copies

Copying	
- Document glass.....	20
- RSPF.....	21
Enlarging/reducing copies.....	25
Exposure, adjusting.....	24
Exposure, selecting.....	24
Setting the number of copies.....	23
Tray, selecting.....	23

Using convenient copy functions

2 IN 1 copying, using	
- Document glass.....	31
- RSPF.....	33
Automatic two-sided copying	
- Document glass.....	27
- RSPF.....	28
Margin shift, using.....	34
Sort copying, using	
- Document glass.....	29
- RSPF.....	30

Connecting the computer

Basic procedure for printing.....	50
Button Manager, setting up	
- Windows 98/Me/2000.....	47
- Windows XP/Vista.....	45
Installing the software.....	38
Online manual, using.....	53
Print job, canceling.....	50
Printer mode, using.....	50
Scanner mode, using.....	51
Scanning from your computer.....	52
Scanning using the keys on the machine.....	51

Troubleshooting and maintenance

Checking the total count.....	77
Cleaning the machine	
- Cabinet.....	78
- Document glass.....	78
- RSPF.....	78
- Transfer charger.....	79
Misfeeds, removing	
- Fusing area.....	71
- RSPF.....	73
- Paper feed area.....	71
- Transport area.....	72
Toner cartridge, replacing.....	74

MEMO

MEMO

For users in the USA

This device complies with Part 15 of the FCC Rules. Operation is subject to the following two conditions: (1) This device may not cause harmful interference, and (2) this device must accept any interference received, including interference that may cause undesired operation.

WARNING:

FCC Regulations state that any unauthorized changes or modifications to this equipment not expressly approved by the manufacturer could void the user's authority to operate this equipment.

Note:

This equipment has been tested and found to comply with the limits for a Class B digital device, pursuant to Part 15 of the FCC Rules. These limits are designed to provide reasonable protection against harmful interference in a residential installation. This equipment generates, uses and can radiate radio frequency energy and, if not installed and used in accordance with the instructions, may cause harmful interference to radio communications.

However, there is no guarantee that interference will not occur in a particular installation. If this equipment does cause harmful interference to radio or television reception, which can be determined by turning the equipment off and on, the user is encouraged to try to correct the interference by one or more of the following measures:

- Reorient or relocate the receiving antenna.
- Increase the separation between the equipment and receiver.
- Connect the equipment into an outlet on a circuit different from that to which the receiver is connected.
- Consult the dealer or an experienced radio/TV technician for help.

Notice for Users in U.S.A.

Declaration of Conformity

SHARP Digital Multifunctional System, AR-208S/AR-208D

This device complies with Part 15 of the FCC Rules. Operation is subject to the following two conditions: (1) This device may not cause harmful interference, and (2) this device must accept any interference received, including interference that may cause undesired operation.

Responsible Party: SHARP ELECTRONICS CORPORATION
Sharp Plaza, Mahwah, New Jersey 07430

TEL: 1-800-BE-SHARP

This product utilizes tin-lead solder, and fluorescent lamp containing a small amount of mercury. Disposal of these materials may be regulated due to environmental consideration. For disposal or recycling information, please contact your local authorities, the Electronics Industries Alliance: www.eiae.org, the lamp recycling organization: www.lamprecycle.org or Sharp at 1-800-BE-SHARP.
(For U.S.A. Only)

SHARP®

SHARP ELECTRONICS CORPORATION

1 Sharp Plaza, Mahwah, New Jersey 07430-1164.

www.sharppusa.com

SHARP ELECTRONICS OF CANADA LTD.

335 Britannia Road East, Mississauga, Ontario, L4Z 1W9

SHARP CORPORATION



This manual has been printed using a vegetable-based soy oil ink to help protect the environment.
Printed on 100% post-consumer recycled paper

PRINTED IN CHINA
2007M KS2
TINSE1862QSZZ

SHARP®



FACSIMILE EXPANSION KIT

OPERATION MANUAL

	Page
• INSTALLATION	11
• INITIAL SETTINGS	13
• CHOOSING SUITABLE MEDIA	50
• HOW TO USE THE FAX FUNCTION	52
• SPECIAL FUNCTIONS	67
• TROUBLESHOOTING	85
• APPENDIX	92

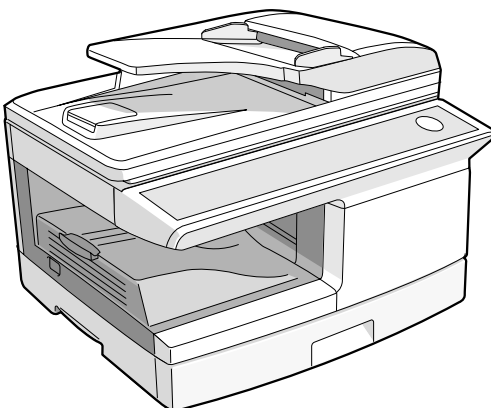

For users in the USA

This device complies with Part 15 of the FCC Rules. Operation is subject to the following two conditions: (1) This device may not cause harmful interference, and (2) this device must accept any interference received, including interference that may cause undesired operation.

WARNING:

FCC Regulations state that any unauthorized changes or modifications to this equipment not expressly approved by the manufacturer could void the user's authority to operate this equipment.

Note:

This equipment has been tested and found to comply with the limits for a Class B digital device, pursuant to Part 15 of the FCC Rules. These limits are designed to provide reasonable protection against harmful interference in a residential installation. This equipment generates, uses and can radiate radio frequency energy and, if not installed and used in accordance with the instructions, may cause harmful interference to radio communications.

However, there is no guarantee that interference will not occur in a particular installation. If this equipment does cause harmful interference to radio or television reception, which can be determined by turning the equipment off and on, the user is encouraged to try to correct the interference by one or more of the following measures:

- Reorient or relocate the receiving antenna.
- Increase the separation between the equipment and receiver.
- Connect the equipment into an outlet on a circuit different from that to which the receiver is connected.
- Consult the dealer or an experienced radio/TV technician for help.

This product utilizes a CR coin Lithium battery which contains a Perchlorate material. Special handling for this material may apply, California residents, See www.dtsc.ca.gov/hazardouswaste/perchlorate/
Others, consult local environmental officers.

Caution

- Use only the line cable that was provided with the machine.
- To reduce the risk of fire, use only UL-Listed No.26 AWG or larger telecommunication line cord.

Note

- This manual (fax function) describes the AR-208S/AR-208D model with optional facsimile expansion kit (AR-FX13) installed. Depending on the model you have and on the options installed, some of the illustrations in this manual may be different, however, the basic operations are the same.
- This manual describes how to use the fax function of the machine. Part names and functions shared with the copy function (for example, the misfeed indicator and add paper indicator), are described in the Operation Manual (for general information). For more information, please read the Operation Manual (for general information).
- This operation manual refers to the Reversing Single Pass Feeder as the "RSPF".

INTRODUCTION

TYPE OF SERVICE

This equipment may not be used on coin-operated (pay phone) phone service. Connection to party lines service is subject to state tariffs. Contact your state's public utility commission, public service commission, or corporation commission for more information.

ABOUT THE TELEPHONE CONSUMER PROTECTION ACT OF 1991

The Telephone Consumer Protection Act of 1991 makes it unlawful for any person to use a computer or other electronic device, including FAX machines, to send any message unless such message clearly contains in a margin at the top or bottom of each transmitted page or on the first page of the transmission, the date and time it is sent and an identification of the business or other entity, or other individual sending the message and the telephone number of the sending machine or such business, other entity, or individual.

(The telephone number provided may not be a 900 number or any other number for which charges exceed local or long-distance transmission charges.)

In order to program this information into your FAX machine, you should complete the following steps:
See page 21 of this Operation Manual.

Important safety instructions

- If any of your telephone equipment is not operating properly, you should immediately remove it from your telephone line, as it may cause harm to the telephone network.
- The AC power outlet shall be installed near the equipment and shall be easily accessible.
- Never install telephone wiring during a lightning storm.
- Never install telephone jacks in wet locations unless the jack is specifically designed for wet locations.
- Never touch uninsulated telephone wires or terminals unless the telephone line has been disconnected at the network interface.
- Use caution when installing or modifying telephone lines.
- Avoid using a telephone (other than a cordless type) during an electrical storm. There may be a remote risk of electric shock from lightning.
- Do not use a telephone to report a gas leak in the vicinity of the leak.
- Do not install or use the machine near water, or when you are wet. Take care not to spill any liquids on the machine.
- Save these instructions.

FCC Notice to users:

This equipment complies with Part 68 of the FCC rules and the requirements adopted by the ACTA. On this equipment is a label that contains, among other information, a product identifier in the format US:AAAEQ##TXXXX.

If requested, this number must be provided to the telephone company.

The REN is used to determine the number of devices that may be connected to a telephone line. Excessive RENs on a telephone line may result in the devices not ringing in response to an incoming call. In most but not all areas, the sum of RENs should not exceed five (5.0).

To be certain of the number of devices that may be connected to a line, as determined by the total RENs, contact the local telephone company.

For products approved after July 23, 2001, the REN for this product is part of the product identifier that has the format US:AAAEQ##TXXXX.

The digits represented by ## are the REN without a decimal point (e.g., 03 is a REN of 0.3).

For earlier products, the REN is separately shown on the label.

If this equipment causes harm to the telephone network, your telephone company may disconnect your service temporarily. If possible, They will notify you in advance. If advance notice is not practical, you will be notified as soon as possible. You will also be advised of your right to file a complaint with the FCC.

Your telephone company may make changes in its facilities, equipment, operations, or procedures that could affect the operation of your equipment. If this happens, the telephone company will provide advance notice in order for you to make necessary modifications to maintain uninterrupted service. If the equipment is causing harm to the telephone network, your telephone company may ask you to disconnect the equipment until the problem is resolved.

If you have any questions or problems which cannot be solved by reading this manual, please contact

<p>Sharp Electronics Corporation 1 Sharp Plaza, Mahwah, New Jersey 07430 Telephone: 1-800-BE-SHARP</p>

A plug and jack used to connect this equipment to the premises wiring and telephone network must comply with the applicable FCC Part 68 rules and requirements adopted by the ACTA.

A compliant telephone cord and modular plug is provided with this product.

It is designed to be connected to a compatible modular jack that is also compliant. See installation instructions for details.

This equipment connects to the telephone network through a standard USOC RJ-11C network interface jack.

If your home has specially wired alarm equipment connected to the telephone line, ensure the installation of this equipment does not disable your alarm equipment.

If you have questions about what will disable alarm equipment, consult your telephone company or a qualified installer.

TABLE OF CONTENTS

INTRODUCTION	i
QUICK REFERENCE GUIDE	3
LIST OF FAX FUNCTIONS.....	6

1 INSTALLATION

CONNECTIONS	11
● CONNECTING THE TELEPHONE LINE CORD ...	11
FINAL PREPARATIONS	12
● CONNECTING OTHER DEVICES	12

2 INITIAL SETTINGS

PART NAMES	13
A LOOK AT THE FAX OPERATION PANEL	14
ABOUT THE LIQUID CRYSTAL DISPLAY	16
USING THE ARROW KEYS	16
ADJUSTING THE BEEP VOLUME	16
ADJUSTING THE RINGING VOLUME.....	17
SETTING THE LENGTH OF ALARM BEEPS	18
ADJUSTING THE ALARM BEEP VOLUME ..	19
FAX SETUP	20
● HOW TO ENTER CHARACTERS	20
● ENTERING YOUR NAME AND FAX NUMBER.....	21
● SETTING THE DATE AND TIME	22
● SELECTING THE TRANSMISSION MODE ..	26
● SELECTING THE RECEPTION MODE.....	27
● SETTING THE NUMBER OF RINGS FOR AUTO RECEPTION	28
● SETTING THE NUMBER OF RINGS FOR MANUAL RECEPTION	29
● SELECTING THE RECEPTION PAPER SIZE ..	29
● SETTING THE TRAY SELECTION.....	30
● SETTING THE DIAL MODE	31
● SETTING THE NUMBER OF RECALL TIMES.....	32
● SETTING THE RECALL INTERVAL.....	34
● SETTING THE INDEX FUNCTION.....	36
● SETTING RESOLUTION PRIORITY	37
● SETTING UP THE MACHINE FOR USE WITH A PC MODEM.....	38
● USING THE REMOTE RECEPTION FUNCTION	39
● DISTINCTIVE RINGING	41
● STORING NUMBERS FOR AUTOMATIC DIALING.....	42
● STORING NUMBERS UNDER GROUP KEYS	45

USING THE MACHINE WITH AN ANSWERING MACHINE.....	48
● QUIET DETECT TIME	48
● ANSWERING MACHINE BACKUP.....	49

3 CHOOSING SUITABLE MEDIA

ORIGINALS SUITABLE FOR FAXING	50
● SIZE AND WEIGHT	50
● UNSUITABLE ORIGINALS	51

4

HOW TO USE THE FAX FUNCTION

SENDING ORIGINALS	52
● SETTING THE ORIGINAL	52
OPTIONAL TRANSMISSION SETTINGS	54
● ORIGINAL SIZE	54
● RESOLUTION	55
● CONTRAST	55
● COVER SHEET	56
● MESSAGE FUNCTION	57
● TWO-SIDED ORIGINAL TRANSMISSION FUNCTION	58
DIALING AND TRANSMITTING	59
● DIRECT KEYPAD DIALING	59
● RAPID KEY DIALING	59
● SPEED DIALING	59
● CHAIN DIALING	60
● NORMAL DIALING USING THE [SPEAKER] KEY	60
● USING THE SEARCH KEY	61
● REDIALING	61
IF THE MEMORY BECOMES FULL WHILE SCANNING AN ORIGINAL	62
CANCELING (DELETING) A STORED FAX JOB ..	62
RECEIVING FAXES	63
● USING AUTO MODE	63
● USING MAN. MODE	63
● USING A.M. MODE	63
OPTIONAL RECEPTION SETTINGS	64
● TWO-SIDED RECEPTION (AR-208D only) ..	64
● RECEIVE REDUCE	65
WHEN USING MANUAL SENDING AND RECEIVING	66

5

SPECIAL FUNCTIONS

MEMORY	67
DATA TRANSFER	68
TRANSMISSION RESERVATION	70
BROADCASTING	71
POLLING	73
● POLLING	73
● SERIAL POLLING	74
● POLLING TRANSMISSION (MEMORY POLLING)	75
● RESTRICTING POLLING MACHINES (POLLING SECURITY)	77
TIMER OPERATIONS	79
● CANCELING A TIMER TRANSMISSION JOB ..	80
ANTI JUNK FAX	81
OPERATION IN COPY, PRINTER, SCANNER, AND FAX MODES	84

6

TROUBLESHOOTING

PRINTING OUT REPORTS	85
● ACTIVITY REPORT AUTO LISTING	88
● PRINTING TRANSACTION REPORTS	89
TROUBLESHOOTING	90
MESSAGES AND SIGNALS	91
● DISPLAY MESSAGES	91
● AUDIBLE SIGNALS	91

7

APPENDIX

SPECIFICATIONS	92
INDEX	93

QUICK REFERENCE GUIDE

The following quick reference guide provides brief explanations the operation of the machine.

Selecting the transmission mode (p.26)

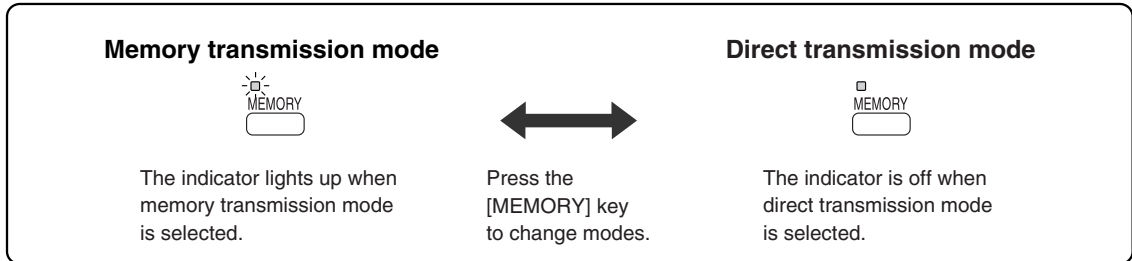



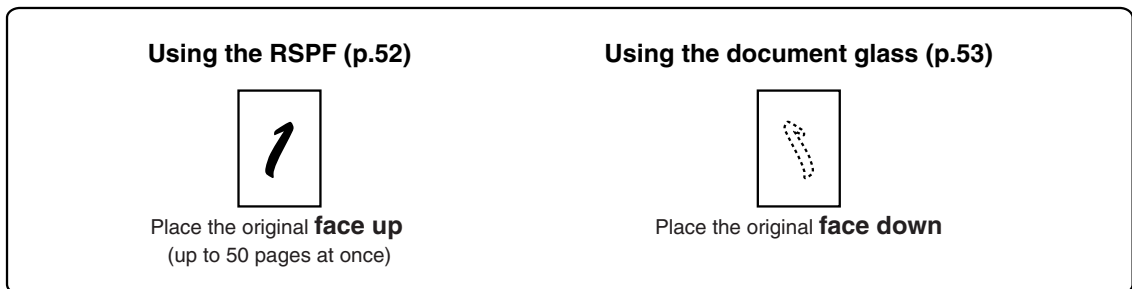

Place the original

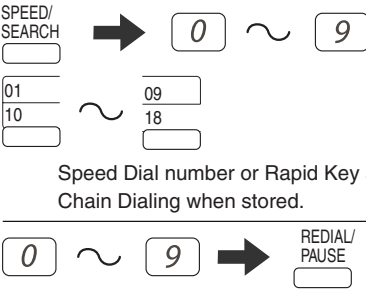
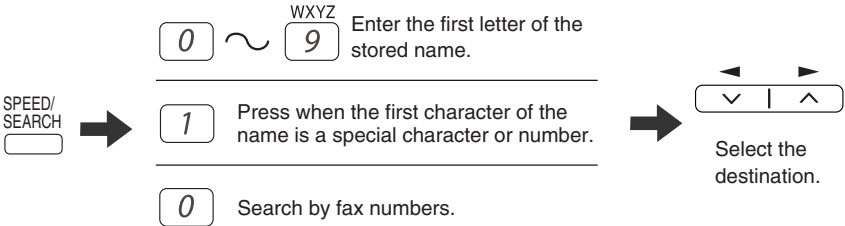

Sending a fax

Dialing methods

Direct Dialing (p.59)	 Press the numeric keys to dial.
Speed Dialing (p.59)	 Enter a two-digit Speed Dial number.
Rapid Key Dialing (p.59)	 * It is not necessary to press the [START] key after pressing a Rapid Key.
Chain Dialing (p.60)	 <p>Speed Dial number or Rapid Key set for Chain Dialing when stored.</p> <p>Dial with the numeric keys and then press the [REDIAL/PAUSE] key.</p> <p>→ Dial the next part of the number (a Group Key cannot be used).</p>
Search Dialing (p.61)	 <p>Enter the first letter of the stored name.</p> <p>Press when the first character of the name is a special character or number.</p> <p>Search by fax numbers.</p> <p>Select the destination.</p>
Redialing (p.61)	 Redial the last number dialed.

Sending a fax

Using the RSPF

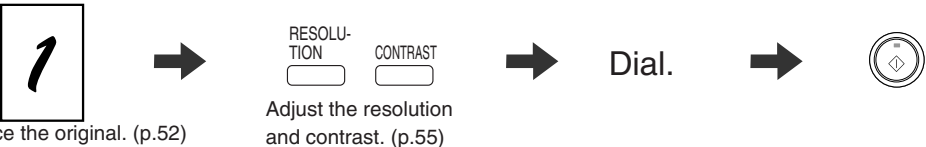

Place the original. (p.52)

Adjust the resolution and contrast. (p.55)

Dial.

Start key (⊙)

Using the document glass



Place the original. (p.53)

Specify the original size. (p.54)

Adjust the resolution and contrast. (p.55)

Dial.

If you are faxing a multi-page original, change pages and press the [START] key (⊙).

#

Sending a fax to multiple destinations (Broadcasting) (p.71)

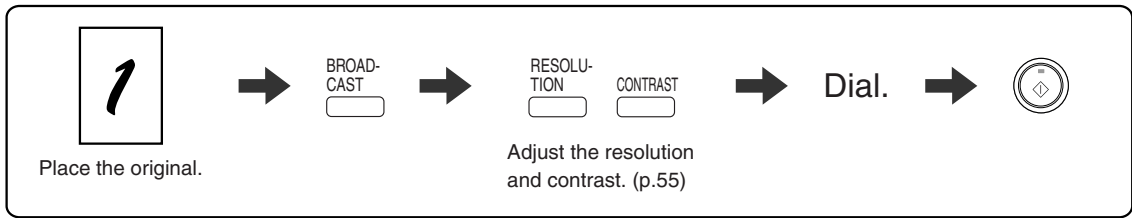

Storing a fax job while another job is in progress

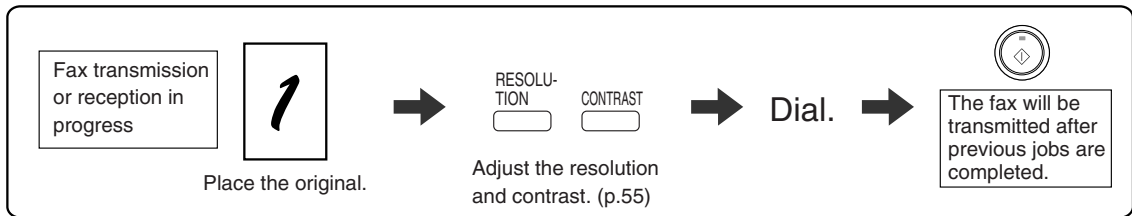

Automatically sending a fax at a specified time (timer transmission)

To set up a timer transmission, see "TIMER OPERATIONS" (p.79).

Receiving a fax

Selecting the reception mode (p.63)

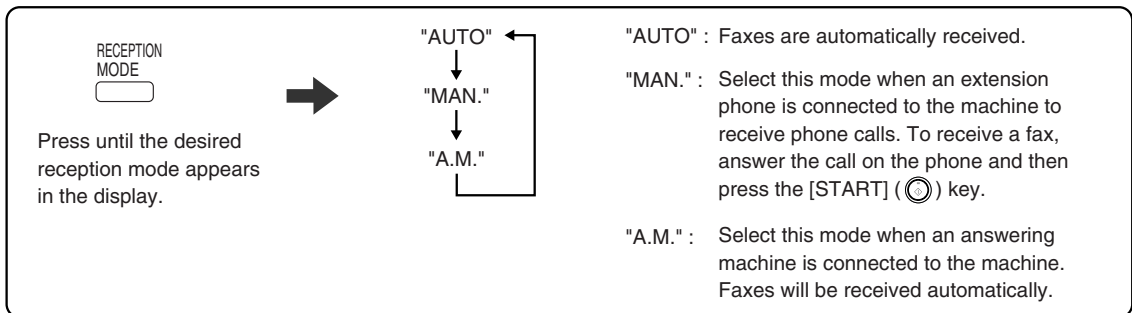

Calling a fax machine and requesting automatic transmission of an original placed in that machine (p.73)

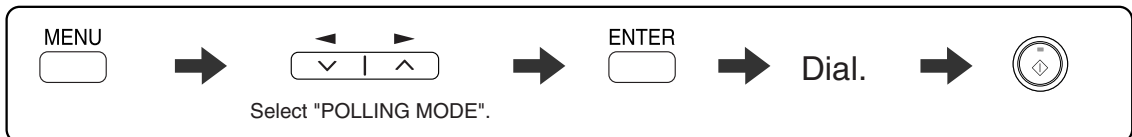

* Another fax machine can also call your fax machine and request automatic transmission of a original placed in your machine. For this to take place, the reception mode of your machine must be set to "AUTO".

LIST OF FAX FUNCTIONS

The FAX MAIN MENU is used to configure settings for the fax function and program information such as the fax number of the machine. The settings in the FAX MAIN MENU are shown below.

The procedure for configuring settings is explained in "SELECTING SETTINGS FOR THE FUNCTION" (p.10).

Menu item	Settings (factory default setting appears in bold)	Page
0 : RX DATA TRANSFER		
1 : DATA TRANSFER	Enable transfer of received faxes to another fax machine when printing is not possible.	69
2 : FAX NUMBER	Program the fax number of the machine to which received faxes will be transferred.	68
1 : TIMER MODE		
1 : SET	Set up a transmission or polling job to take place automatically at a specified time.	79
2 : CLEAR	Cancel a timer transmission job.	79
2 : ENTRY MODE		
1 : FAX NUMBER	Store (or delete) fax numbers in Rapid Keys, Speed Dial numbers, and Group Keys. 1 : RAPID KEY 2 : SPEED # 3 : GROUP KEY	42, 44, 45, 47
2 : DATE&TIME SET	Set the date and time in the machine.	22
3 : OWN PASSCODE SET	Program the name and phone number of the user of the machine.	21
4 : PASSCODE # MODE	Store fax numbers that are allowed to poll the machine when polling security is used.	78
5 : DAY LIGHT SAVING	Enable automatic adjustment of the clock at the beginning and end of daylight savings time.	25
3 : MEMORY STATUS	Check and delete stored fax jobs waiting for transmission and automatic recall jobs.	62
4 : USER PROGRAM		
1 : DOC. GLASS SIZE	Set the size of an original faxed from the document glass. 1 : 8.5x11 2 : 8.5x14 3 : A4	54
2 : FIXED DOC. SIZE	Set the default size of originals faxed from the document glass. 1 : 8.5x11 2 : 8.5x14 3 : A4	54
3 : RESO. PRIORITY	Set the default resolution for fax transmission. 1 : STANDARD 2 : FINE 3 : SUPER FINE	37
4 : # OF RINGS (AUTO)	Set the number of rings on which the machine answers calls in automatic reception mode. 0 - 9 (2)	28
5 : # OF RINGS (MANUAL)	Set the number of rings on which the machine answers calls in manual reception mode. 0 - 9 (0)	29

Menu item	Settings (factory default setting appears in bold)	Page
6 : AUTO LISTING	Enable automatic printing of the Activity Report when information on a total of 50 fax transmissions/receptions accumulates. 1 : ON 2 : OFF	88
7 : PRINT SELECTION	1 : TRANSMISSION Select the condition for printing reports on fax transmissions. 1 : ALWAYS PRINTS 2 : ERROR ONLY 3 : NEVER PRINTS	89
	2 : BROADCAST Select the condition for printing reports on broadcast transmissions. 1 : ALWAYS PRINTS 2 : ERROR ONLY 3 : NEVER PRINTS	89
	3 : RECEPTION Select the condition for printing reports on received faxes. 1 : ALWAYS PRINTS 2 : ERROR ONLY 3 : NEVER PRINTS	89
	4 : IMAGE MEM. PRINT Enable printing of the original image on transaction reports. 1 : ALWAYS PRINTS 2 : ERROR ONLY 3 : NEVER PRINTS	89
8 : RECALL TIMES BUSY	Set the number of recall attempts that are made when the line is busy. 00 - 14 (02)	32
9 : RECALL TIMES ERR	Set the number of recall attempts that are made when a communication error occurs. 0 - 1 (1)	33
10 : RECALL INT. BUSY	Set the interval between recall attempts when the line is busy. 1 to 15 minutes can be selected. 01 - 15 min. (03 min.)	34
11 : RECALL INT. ERR	Set the interval between recall attempts when a communication error occurs. 0 to 15 minutes can be selected. 00 - 15 min. (01 min.)	35
12 : SECURITY SELECT	Enable the polling security function. 1 : ON 2 : OFF	77
13 : FAX REMOTE NUMBER	Set the 1-digit number used to activate remote fax reception. 0 - 9 (5)	40
14 : REMOTE RECEPTION	Enable the remote reception function. 1 : ON 2 : OFF	39
15 : FAX SIGNAL RCV	Enable automatic fax reception when a fax tone is heard after answering a call on an extension phone. 1 : ON 2 : OFF	38

Menu item	Settings (factory default setting appears in bold)	Page
16 : RCV REDUCE	When a fax is received that is larger than the printing paper, enable reduction of the fax to the size of the paper to avoid the fax being cut off. 1 : ON 2 : OFF	65
17 : BEEP LENGTH	Set the length of the beep that sounds when fax transmission or reception ends. 1 : 3 SEC 2 : 1 SEC 3 : NO BEEP	18
18 : RINGER VOLUME	Set the volume of the ringer. 1 : OFF 2 : LOW 3 : MIDDLE 4 : HIGH	17
19 : BEEPER VOLUME	Set the volume of the beep that sounds when a key is pressed. 1 : OFF 2 : LOW 3 : MIDDLE 4 : HIGH	19
20 : DIAL MODE	Set the dial mode for the type of line you are on. 1 : TONE 2 : PULSE	31
21 : DISTINCTIVE RING	Set the ring pattern for distinctive ring. 1 : OFF 2 : STANDARD 3 : PATTERN 1 4 : PATTERN 2 5 : PATTERN 3 6 : PATTERN 4 7 : PATTERN 5	41
22 : INDEX PRINT	Enable printing of a black mark (index) at the top of each received fax page. 1 : ON 2 : OFF	36
23 : DATE&TIME FORMAT	1 : TIME FORMAT Select 12-hour or 24-hour format for the time set in the machine. 1 : 12 HOUR 2 : 24 HOUR	23
	2 : DATE FORMAT Set the format of the date in the display and in printouts. 1 : MMDDYYYY 2 : DDMMYYYY 3 : YYYYMMDD	24
24 : 2-SIDED RX (AR-208D only)	Print on both sides of the paper when a multi-page fax is received. 1 : ON 2 : OFF	64
25 : TRAY SELECTION (When the 250-sheet paper feed unit is installed.) ("24: TRAY SELECTION" when the AR-208S is used.)	Set the tray for printing received faxes. 1 : AUTO 2 : TRAY 1 3 : TRAY 2	30

Menu item	Settings (factory default setting appears in bold)	Page
5 : ANTI JUNK FAX		
1 : ANTI JUNK SELECT	Enable the anti junk function to block fax reception from specified fax numbers. 1 : ON 2 : OFF	81
2 : JUNK FAX #	Program (or delete) fax numbers from which fax reception is to be blocked. 1 : SET 2 : CLEAR	82
6 : A.M. MODE		
1: QUIET DETECT TIME	Activate fax reception when a period of silence longer than the set time is detected. 00 - 10 (05)	48
2 : AUTO RECEIVE	Enable fax reception when the answering machine is full and cannot receive messages or otherwise fails. 1 : ON 2 : OFF	49
7 : MEMORY POLL MODE		
1 : 1 TIME	Perform polling transmission once.	75
2 : REPEAT	Perform polling transmission repeatedly.	75
8 : POLLING MODE	Poll another fax machine.	73
9 : SERIAL POLL MODE	Sequentially poll multiple fax machines.	74

SELECTING SETTINGS FOR THE FUNCTION

The general procedure for configuring settings for the fax function is explained below. Follow this procedure to configure the settings explained on pages 6 through 9.



An item can also be selected after pressing the [MENU] key by pressing the numeric key for the item (the key corresponding to the number that appears in front of the item). When the numeric key is pressed, the item is selected or entered.

1 Press the [MODE SELECT] key to select fax mode.

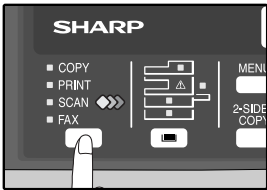

The "FAX" indicator lights up to indicate that fax mode is selected.

2 Press the [MENU] key.

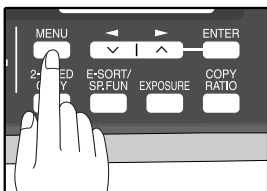

"FAX MAIN MANU" will appear in the display.

3 Press the [◀] key (◀) or [▶] key (▶) to select a menu item and press the [ENTER] key.

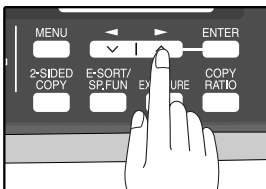

The item is selected. Repeat this step until the item that you wish to configure appears.

4 Select a setting or enter information.

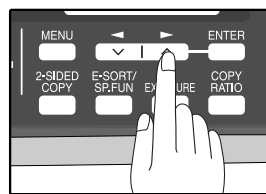

To select a setting:
Press the [◀] key (◀) or [▶] key (▶) until the setting is selected.

To enter information:
Press the numeric keys to enter characters or numbers.



- If you mistakenly select the wrong item, press the [CLEAR] key (C) and repeat the procedure from step 2.
- To cancel a setting for a fax function, press the [MENU] key.

5 Press the [ENTER] key.

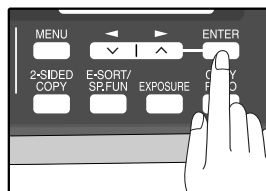

The setting or information is entered.

6 Press the [MENU] key.

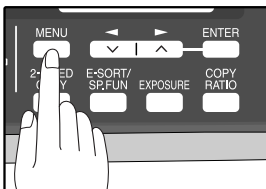

Press the [MENU] key to exit.

CONNECTIONS

CONNECTING THE TELEPHONE LINE CORD

Plug one end of the telephone line cord into the jack on the machine marked "LINE." Plug the other side into a standard (RJ11C) single-line telephone wall jack. Be sure not to plug this telephone line cord into the "TEL" jack. The "TEL" jack is used to attach an extension telephone or answering machine to the machine. (See "CONNECTING OTHER DEVICES" (p.12))



If your area experiences a high incidence of lightning or power surges, we recommend that you install surge protectors for the power and telephone lines. Surge protectors can be purchased from your retailer or at most telephone specialty stores.

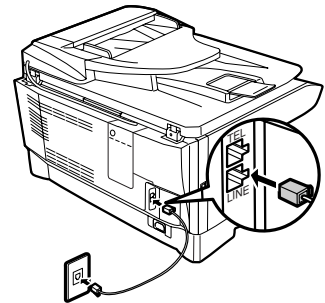

ABOUT THE OPERATION MANUALS

The operation manuals for the machine are as follows:

Facsimile Expansion Kit Operation Manual (this manual)

This manual explains the procedures for using the machine as a fax machine.

This manual only explains the fax functions of the machine. For general information on using the machine, including safety information, installation, paper loading, removal of paper misfeeds, and peripheral equipment, see the operation manual for the machine.

Operation Manual (for general information)

Explains the machine and how to use it as a copier. Also explains how to install the software that allows the machine to be used as a printer and scanner for your computer.

The following information is contained in the operation manual for the machine :

OPERATION MANUAL contents	Page
CAUTIONS	3
PART NAMES	9
POWER ON AND OFF	12
LOADING THE PAPER TRAY	15
BYPASS FEED (including special paper)	17

OPERATION MANUAL contents	Page
CHANGING A TRAY'S PAPER SIZE SETTING	19
MISFEED REMOVAL	70
TONER CARTRIDGE REPLACEMENT	74
CHECKING THE TOTAL COUNT	77
CLEANING THE MACHINE	78

Online Manual (on the CD-ROM)

This manual explains the procedures for using the machine as a printer and a scanner.

FINAL PREPARATIONS

CONNECTING OTHER DEVICES

If desired, an answering machine or external telephone can be connected to the machine through the telephone jack, labeled "TEL," on the rear of the machine.

- Connecting an answering machine to the machine allows you to receive both voice and fax messages when you are out. To use this feature, first change the outgoing message of your answering machine, and then set the reception mode of the machine to "A.M." (Answering Machine mode) when you go out.



If you are using distinctive ringing with an answering machine, you do not need to follow the procedure described below. (Please note that when distinctive ringing is used, the answering machine must be distinctive ring compatible.)

Comments:

1. It is advisable to keep the length of the message under 10 seconds. If it is too long, you may have difficulty receiving faxes sent by automatic dialing.
 2. Your callers can even leave a voice message and send a fax message on the same call. Modify your outgoing message to explain that this can be done by pressing their [START] key (Ⓢ) after leaving their voice message.
- You can connect an extension phone to the machine to make and receive calls like any other extension phone on your line. Even if you pick up the extension phone and hear a fax tone, the machine will automatically cut in and take over the line. Note, however, if you also have a PC modem on the same line, you must turn on the Remote Reception function, and deactivate the Fax Signal Receive function. See "SETTING UP THE MACHINE FOR USE WITH A PC MODEM" (p.38) and "USING THE REMOTE RECEPTION FUNCTION" (p.39).



The Remote Reception function is initially set to "ON".

2

Chapter 2

INITIAL SETTINGS

PART NAMES

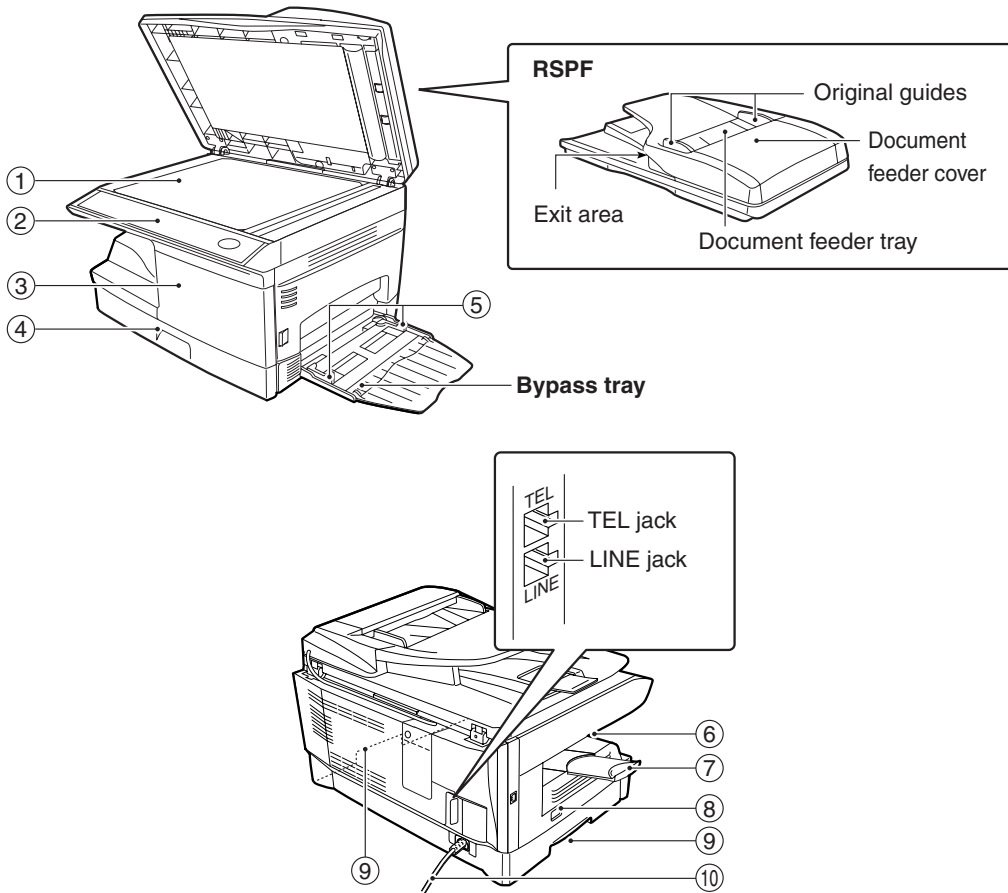

- ① Document glass
- ② Operation panel
- ③ Front cover
- ④ Paper tray
- ⑤ Bypass tray paper guides

- ⑥ Paper output tray
- ⑦ Paper output tray extension
- ⑧ Power switch
- ⑨ Handles
- ⑩ Power cord

A LOOK AT THE FAX OPERATION PANEL

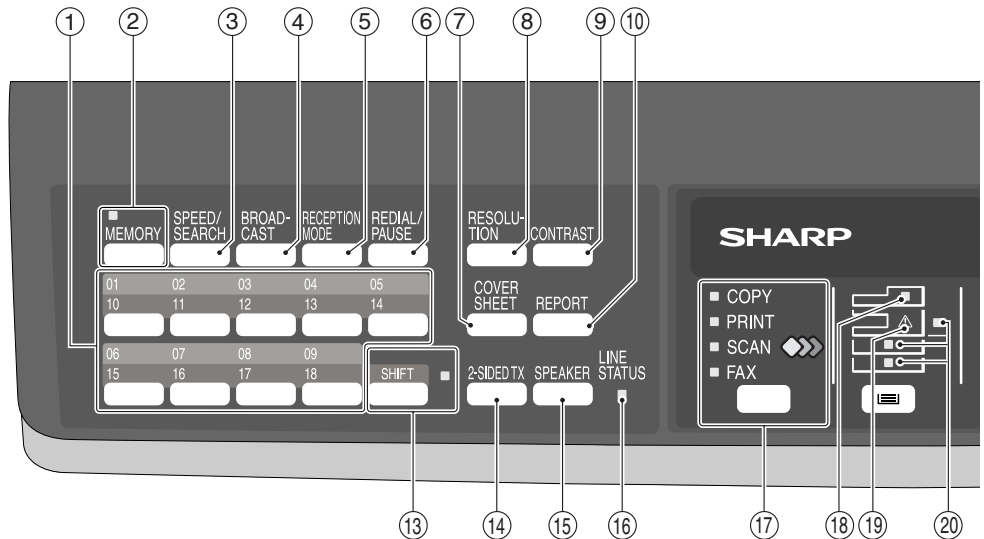

- ① **Rapid keys**
Press one of these keys to dial a fax or telephone number automatically.
- ② **[MEMORY] key / indicator**
Used for sending faxes in memory (indicator is lit) or direct sending (indicator is not lit).
- ③ **[SPEED/SEARCH] key**
Press this key to dial a two digit Speed Dial number.
During character inputting, use this key to delete an incorrect entry.
Also, press this key twice to search for an automatic dialing number.
- ④ **[BROADCAST] key**
Press this key to send originals to a group of receiving fax machines.
- ⑤ **[RECEPTION MODE] key**
Press this key to select the mode of reception.
- ⑥ **[REDIAL/PAUSE] key**
Press this key to automatically redial the last number you dialed.
Also, press this key to insert a pause when entering numbers.
- ⑦ **[COVERSHEET] key**
Press this key to automatically add a cover sheet and message to a fax.
- ⑧ **[RESOLUTION] key**
Press this key to adjust the resolution before sending faxes.
- ⑨ **[CONTRAST] key**
Press this key to adjust the contrast before sending faxes.
- ⑩ **[REPORT] key**
Press this key to print out a report of a fax transaction and also when receiving a confidential fax.
- ⑪ **Display**
Shows various messages during fax operation and programming.
- ⑫ **[CLEAR] key (C)**
Press this key to stop an operation before it is completed, or to delete the number that was last input.
When a setting menu appears, use this key to move back to the previous menu level.
- ⑬ **[SHIFT] key / indicator**
Press this key to switch between upper and lower case.
- ⑭ **[2-SIDED TX] key**
Press this key to fax a two-sided original.

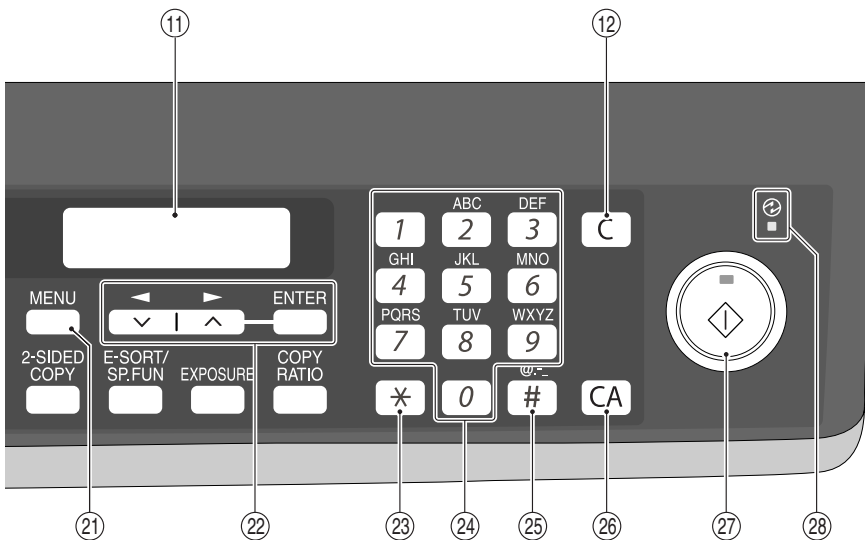

- 15 [SPEAKER] key**
Press this key to begin manual dialing. (To close the line, press the [SPEAKER] key again.)
- 16 LINE STATUS indicator**
Lit when sending/receiving faxes, blinking when receiving data.
- 17 [MODE SELECT] key / Mode indicators**
Press this key to select the mode. The indicator of the selected mode lights (copy, printer, scanner, fax mode indicators).
- 18 RSPF indicator**
This lights up when an original is placed in the RSPF.
- 19 Error indicator**
This lights steadily or blinks when a paper misfeed or other error occurs.
- 20 Tray location indicator**
Indicates the selected paper tray. The indicator blinks when the tray is out of paper or is not closed.
- 21 [MENU] key**
Press this key to configure a user program.
- 22 [◀] key (◀), [▶] key (▶), [ENTER] key**
Press the [◀] key (◀) or [▶] key (▶) to select an item in a function setting menu.
Press the [ENTER] key to enter a selection.
- 23 [*] key**
Press this key to enter symbols during a name storing procedure.
Press the "*" key to change from pulse dialing to tone dialing mode.
- 24 Numeric keys**
Press these keys to dial numbers, and enter numbers and letters during number/name storing procedures.
- 25 [#] key**
Press this key to enter symbols during a name storing procedure. The [#] key scrolls through symbols in the opposite direction of the [*] key.
When dialing, press this key after you are finished scanning originals into memory from the document glass.
- 26 [CLEAR ALL] key (CA)**
This returns all functions to the default settings.
When pressed in a setting menu, this returns the settings and display to the initial state.
- 27 [START] key (▶) / indicator**
Used for the following:
 - To begin sending a fax.
 - Reading an original into memory from the document glass.
 - Manually receiving a fax.
 - Entering and setting information.
- 28 Power save indicator**
This lights up when the power save function is activated.

ABOUT THE LIQUID CRYSTAL DISPLAY

The machine is equipped with a two-line liquid crystal display (LCD) on the operation panel for displaying various messages and settings during operation. This LCD can display up to 20 characters on each line. When the machine is idle, the LCD shows the date, time, reception mode and the stand-by memory available.

Example:

```
NOV 05 WED   08:20 AM
STAND-BY     AUTO 100%
```

When an original is placed in the RSPF, the second line changes from "STAND-BY" to "SEND READY".

When the [MENU] key is pressed to configure a setting, the display appears as shown below.

Example:

```
FAX MAIN MENU
1:TIMER MODE
```

The selected setting or entered information appears on the second line.

USING THE ARROW KEYS

To configure settings and program information, press the [MENU] key and then press the [◀] key (◁) or [▶] key (▷) to select the item that you wish to configure.

The arrows keys can also be used while entering characters to move the cursor.

Example:

```
FAX MAIN MENU
1:TIMER MODE
```

Press the [◀] key (◁) or [▶] key (▷) to change the item selection that appears on the second line.



An item can also be selected after pressing the [MENU] key by pressing the numeric key for the item (the key corresponding to the number that appears in front of the item). When the numeric key is pressed, the item is selected or entered.

ADJUSTING THE BEEP VOLUME

You can adjust the volume of the beep that sounds when a key is pressed.

The key beep volume is adjusted with "KEY TOUCH SOUND" (Program number 15) in the user programs of copy mode. See "User Programs" in the Operation Manual (for general information).

ADJUSTING THE RINGING VOLUME

Adjust the ringing volume of the machine following the procedure below.

1 Press the [MENU] key.

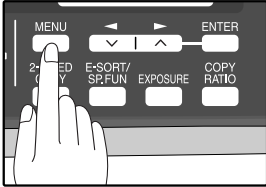

2 Press the [◀] key (⏪) or [▶] key (⏩) until "4:USER PROGRAM" appears, and then press the [ENTER] key.

Selection

"4:USER PROGRAM"

3 Press the [◀] key (⏪) or [▶] key (⏩) until "18:RINGER VOLUME" appears, and then press the [ENTER] key.

Selection

"18:RINGER VOLUME"

4 Press the [◀] key (⏪) or [▶] key (⏩) to set the ringer volume.

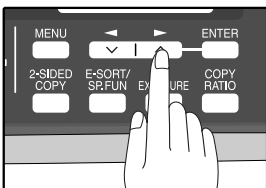

The selections are as follows:

- 1:OFF
- 2:LOW
- 3:MIDDLE
- 4:HIGH

To turn off the ringer, select "1:OFF".



An extension phone will still ring when the machine ringer is set to "1:OFF".

5 Press the [ENTER] key.

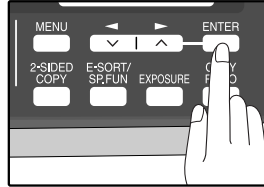

6 Press the [MENU] key.

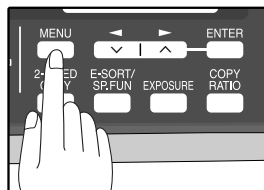

Press the [MENU] key to exit.

2

SETTING THE LENGTH OF ALARM BEEPS

You can select the length in seconds of the alarm beeps (emitted at the end of transmission and reception) following the procedure below.

1 Press the [MENU] key.

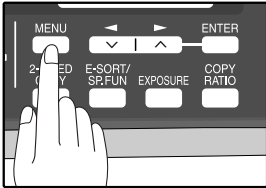

6 Press the [MENU] key.

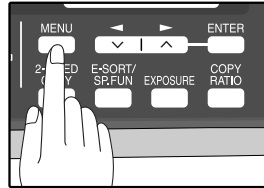

Press the [MENU] key to exit.

2 Press the [◀] key (▽) or [▶] key (▷) until "4:USER PROGRAM" appears, and then press the [ENTER] key.

Selection

"4:USER PROGRAM"

3 Press the [◀] key (▽) or [▶] key (▷) until "17:BEEP LENGTH" appears, and then press the [ENTER] key.

Selection

"17:BEEP LENGTH"

4 Press the [◀] key (▽) or [▶] key (▷) to set the alarm beeps to the desired length or to turn them off.

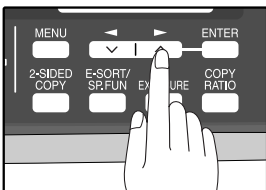

The selections are as follows:

1:3SEC

2:1SEC

3:NO BEEP

5 Press the [ENTER] key.

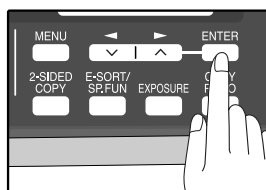

ADJUSTING THE ALARM BEEP VOLUME

Adjust the volume of alarm beeps (emitted at the end of transmission and reception) following the procedure below.

1 Press the [MENU] key.

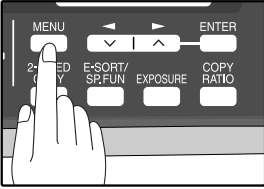

6 Press the [MENU] key.

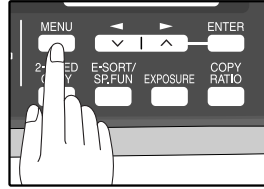

Press the [MENU] key to exit.

2 Press the [◀] key (⏪) or [▶] key (⏩) until "4:USER PROGRAM" appears, and then press the [ENTER] key.

Selection

"4:USER PROGRAM"

3 Press the [◀] key (⏪) or [▶] key (⏩) until "19:BEEPER VOLUME" appears, and then press the [ENTER] key.

Selection

"19:BEEPER VOLUME"

4 Press the [◀] key (⏪) or [▶] key (⏩) to set the alarm volume.

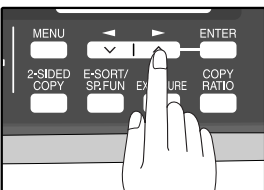

The selections are as follows:

- 1:OFF
- 2:LOW
- 3:MIDDLE
- 4:HIGH

To turn off the alarm, select "1:OFF".

5 Press the [ENTER] key.

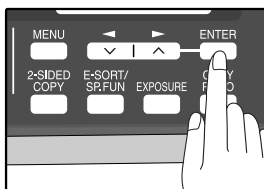

2

FAX SETUP

HOW TO ENTER CHARACTERS

You can enter letters with the numeric keys. Letters are marked above each of the numeric keys [2] through [9]. To enter a letter, press the appropriate key repeatedly until the desired letter appears (the number of the key appears first, followed by letters in the order marked above the key). The keys used for entering characters are shown below.



The following characters can be entered with the numeric keys:

key	Characters that can be entered
1	1 Space
2	A B C 2 a b c
3	D E F 3 d e f
4	G H I 4 g h i
5	J K L 5 j k l
6	M N O 6 m n o
7	P Q R S 7 p q r s
8	T U V 8 t u v
9	W X Y Z 9 w x y z
*	* } [[? > = ; : , +) (& % \$! / _ . @ #
0	0
#	# @ . _ / ! " \$ % & ' () + , ; : = > ? [] { } *

- To enter two characters in succession which require using the same key, press the [▶] key (◀) once after entering the first character, and then enter the second character.
- If you enter an incorrect character or number, follow these steps to correct the mistake.
 1. Press the [◀] key (◀) or [▶] key (◀) to move the cursor to the character immediately following the incorrect character.
 2. Press the [CLEAR] key (□).
The character in front of the cursor is deleted.
 3. Enter the correct character.
The character is inserted in front of the cursor.

ENTERING YOUR NAME AND FAX NUMBER



You can view all of the items in the menu display by pressing the [MENU] key, then using the [◀] key (◀) or [▶] key (▶) to scroll through the function list. Pressing the [ENTER] key chooses the displayed function. Procedures for inputting various items (name, telephone number, date, etc.) are given as follows.

To have your name and fax number printed at the top of every page you transmit, program them by pressing the operation panel keys as shown below.

- If you enter an incorrect character or number, follow these steps to correct the mistake.
 1. Press the [◀] key (◀) or [▶] key (▶) to move the cursor to the character immediately following the incorrect character.
 2. Press the [CLEAR] key (C). The character in front of the cursor is deleted.
 3. Enter the correct character.

IMPORTANT

FCC regulations require that your name, telephone/fax number, and the date and time appear on each fax message you send. Enter your name and fax number here and set the date and time as explained in the following section to have the fax machine include this information automatically at the top of your fax messages.

Use the following procedure to enter your name and fax number:

1 Press the [MENU] key.

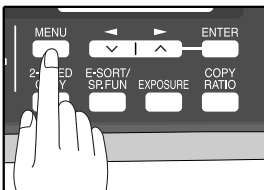

2 Press the [◀] key (◀) or [▶] key (▶) until "2:ENTRY MODE" appears, and then press the [ENTER] key.

Selection

"2:ENTRY MODE"

3 Press the [◀] key (◀) or [▶] key (▶) until "3:OWN PASSCODE SET" appears, and then press the [ENTER] key.

Selection

"3:OWN PASSCODE SET"

4 Press the [◀] key (◀) or [▶] key (▶) to select "1:SET" and then press the [ENTER] key.

Selection

"1:SET"

5 Enter your fax number with the numeric keys.

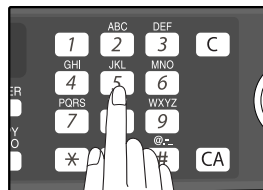

Enter your own fax number (maximum 20 digits) by pressing the Numeric keys.

To insert a "+", press the [*] key.

6 Press the [ENTER] key.

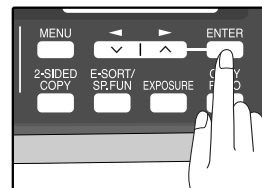

"ENTER NAME" will appear in the display.

7 Enter your name with the numeric keys.

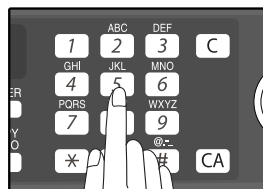

Enter your name by pressing the appropriate Numeric keys as shown on the left. Press each key repeatedly until the desired letter appears in the display (maximum of 36 characters).

To enter a space, press the [1] key twice.

8 Press the [ENTER] key.

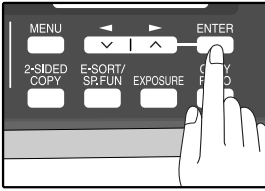

9 Press the [MENU] key.

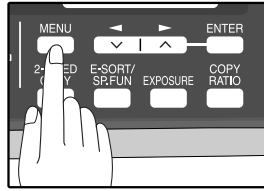

Press the [MENU] key to exit.

SETTING THE DATE AND TIME

The date and time that appear in the display are printed at the top of each page you transmit. Set the date and time by pressing the keys on the operation panel as shown below.

If you enter an incorrect number, press the [CLEAR] key (C) and re-enter the number.

The time can be displayed in 12-hour or 24-hour format. "Month/Day/Year", "Day/Month/Year" or "Year/Month/Day" can be selected for the order of display of the date.

Use the following procedure to set the date and time:

1 Press the [MENU] key.

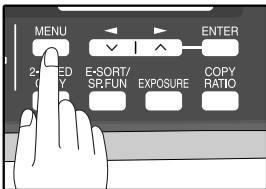

6 Press the [◀] key (left arrow) or [▶] key (right arrow) to select "AM" or "PM".

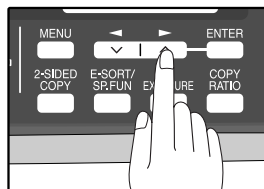

When 24-hour format is selected, do not perform this step.

2 Press the [◀] key (left arrow) or [▶] key (right arrow) until "2:ENTRY MODE" appears, and then press the [ENTER] key.

Selection

"2:ENTRY MODE"

7 Press the [ENTER] key.

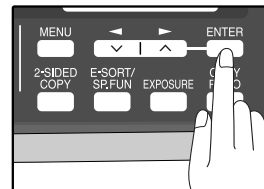

3 Press the [◀] key (left arrow) or [▶] key (right arrow) until "2:DATE&TIME SET" appears, and then press the [ENTER] key.

Selection

"2:DATE&TIME SET"

8 Press the [MENU] key.

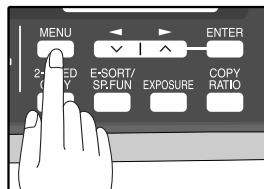

Press the [MENU] key to exit.

4 Enter the year, month, and day with the numeric keys and then press the [ENTER] key.

5 Enter the time with the numeric keys.

To change the display format to 12-hour or 24-hour format, follow the steps below:

1 Press the [MENU] key.

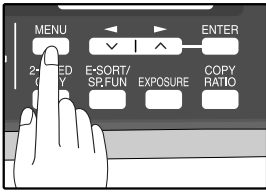

2 Press the [◀] key (▼) or [▶] key (▲) until "4:USER PROGRAM" appears, and then press the [ENTER] key.

Selection

"4:USER PROGRAM"

3 Press the [◀] key (▼) or [▶] key (▲) until "23:DATE&TIME FORMAT" appears, and then press the [ENTER] key.

Selection

"23:DATE&TIME FORMAT"

4 Press the [◀] key (▼) or [▶] key (▲) until "1:TIME FORMAT" appears, and then press the [ENTER] key.

Selection

"1:TIME FORMAT"

5 Press the [◀] key (▼) or [▶] key (▲) to select "1:12HOUR" or "2:24HOUR".

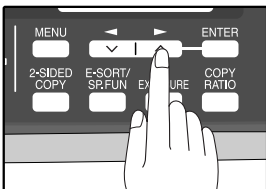

6 Press the [ENTER] key.

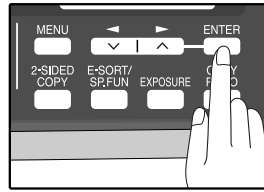

7 Press the [MENU] key.

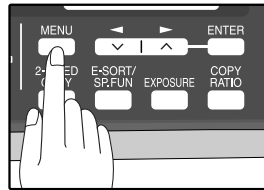

Press the [MENU] key to exit.

2

To change the order of display of the date, follow the steps below:

1 Press the [MENU] key.

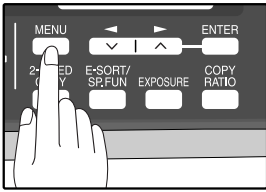

2 Press the [◀] key (▼) or [▶] key (▲) until "4:USER PROGRAM" appears, and then press the [ENTER] key.

Selection

"4:USER PROGRAM"

3 Press the [◀] key (▼) or [▶] key (▲) until "23:DATE&TIME FORMAT" appears, and then press the [ENTER] key.

Selection

"23:DATE&TIME FORMAT"

4 Press the [◀] key (▼) or [▶] key (▲) until "2:DATE FORMAT" appears, and then press the [ENTER] key.

Selection

"2:DATE FORMAT"

5 Press the [◀] key (▼) or [▶] key (▲) to select the display order.

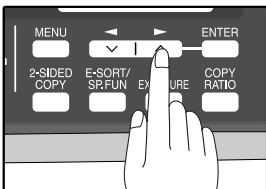

The selections are as follows:

- 1:MMDDYYYY
- 2:DDMMYYYY
- 3:YYYYMMDD

6 Press the [ENTER] key.

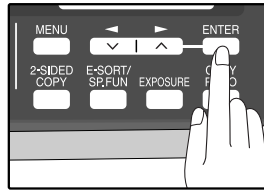

7 Press the [MENU] key.

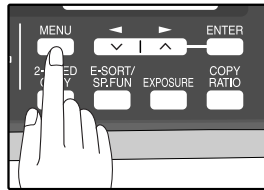

Press the [MENU] key to exit.

Daylight Saving Time Setting

Enable this setting to have the internal clock automatically move forward and backward at the beginning and end of Daylight Saving Time.



If a transmission is in progress when the clock adjustment time for daylight savings time arrives, the clock will not be adjusted until the transmission ends.

Follow these steps to enable Daylight Saving Time.

1 Press the [MENU] key.

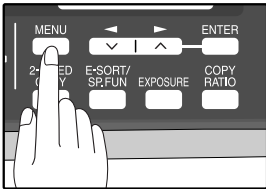

2 Press the [◀] key (▼) or [▶] key (▲) until "2:ENTRY MODE" appears, and then press the [ENTER] key.

Selection

"2:ENTRY MODE"

3 Press the [◀] key (▼) or [▶] key (▲) until "5:DAY LIGHT SAVING" appears, and then press the [ENTER] key.

Selection

"5:DAY LIGHT SAVING"

4 Press the [◀] key (▼) or [▶] key (▲) to select "1:ON" or "2:OFF".

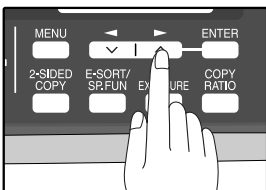

Select "1:ON" to enable the function.
Select "2:OFF" to disable the function.

5 Press the [ENTER] key.

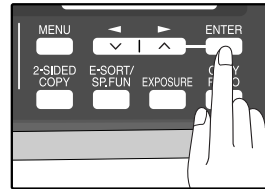

6 Press the [MENU] key.

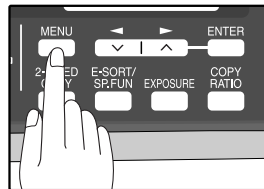

Press the [MENU] key to exit.

2

SELECTING THE TRANSMISSION MODE

The machine has two modes for sending faxes: memory transmission and direct transmission. To change modes, press the [MEMORY] key. The MEMORY indicator lights up when memory transmission is selected, and goes off when direct transmission is selected.

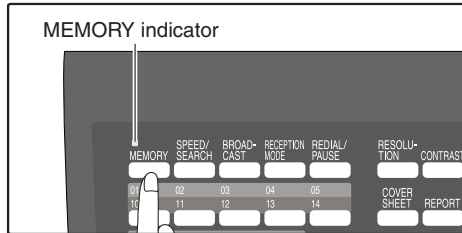

Transmission takes place as follows in each mode:

Memory transmission (the MEMORY indicator is lit)

When a fax is sent from the RSPF and there are no previously stored fax jobs and no job in progress (the telephone line is not being used), dialing and scanning begin at the same time. Each page is transmitted after it is scanned. This transmission method is called Quick Online transmission.

If there are previously stored fax jobs or a job in progress, or the fax is being sent from the document glass, the fax is temporarily scanned into memory before transmission.



When a fax is sent by transmission reservation (p.70), broadcast transmission (p.71), broadcasting using a Group key (p.72), or timer transmission (p.79), the fax is scanned into memory before transmission.

Direct transmission (the MEMORY indicator is off)

The fax is sent directly after the destination is dialed and the connection established.

The machine memory is not used for direct transmission, and thus direct transmission is possible even when the memory is full.



- A fax job cannot be stored while a direct transmission is in progress.
- Only one page can be sent from the document glass by direct transmission.
- A subsequent function cannot be used while a direct transmission is in progress.
Transmission reservation (p.70), broadcast transmission (p.71), broadcasting using a Group key (p.72), or timer transmission (p.79)

SELECTING THE RECEPTION MODE

Your machine has three modes for receiving incoming calls and faxes:

- **AUTO mode:**

Select this mode when you only want to receive faxes on your telephone line. The machine will automatically answer all calls and receive incoming faxes.

- **MAN. mode:**

This is the most convenient mode for receiving phone calls if you have an extension phone. To have true manual mode, the machine must be set to not answer while in MAN. mode (see "SETTING THE NUMBER OF RINGS FOR MANUAL RECEPTION" (p.29)). You can also receive faxes; however, all calls must first be answered by picking up the receiver on the extension phone.

- **A.M. mode:**

Select this mode when an answering machine is connected to the machine and you want the answering machine to answer all calls. This allows you to receive both voice messages and faxes while you are out.



If you are using distinctive ringing as described in "DISTINCTIVE RINGING" on page 41, you must set the reception mode to AUTO. This is true, as well, if you are using an answering machine with distinctive ringing (in this case, the answering machine must be connected to a separate wall jack, not to your machine).

To select the reception mode, press the [RECEPTION MODE] key until the desired reception mode appears in the display.

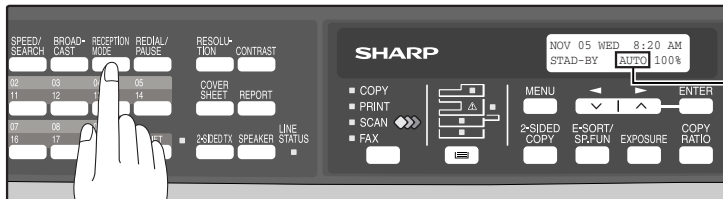

The selected reception mode appears.

For more information on reception modes, refer to "RECEIVING FAXES" (p.63)".

SETTING THE NUMBER OF RINGS FOR AUTO RECEPTION

You can set the number of rings before the machine answers in AUTO mode following the procedure below.

1 Press the [MENU] key.

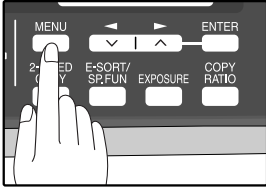

2 Press the [◀] key (◀) or [▶] key (▶) until "4:USER PROGRAM" appears, and then press the [ENTER] key.

Selection

"4:USER PROGRAM"

3 Press the [◀] key (◀) or [▶] key (▶) until "4:# OF RINGS (AUTO)" appears, and then press the [ENTER] key.

Selection

"4:# OF RINGS (AUTO)"

4 Press a numeric key to select the number of rings.



Select the number of rings you would like to use (0 to 9).

5 Press the [ENTER] key.

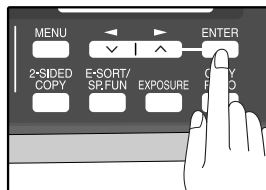

6 Press the [MENU] key.

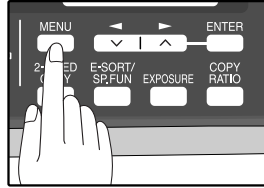

Press the [MENU] key to exit.



Note If an external telephone is connected, the external telephone will ring one time when auto reception is set to 0 rings.

SETTING THE NUMBER OF RINGS FOR MANUAL RECEPTION

The number of rings before the machine answers in MANUAL mode can also be set. If you do not want the machine to answer at all in MANUAL Mode, select "0" in Step 4 below.

1 Press the [MENU] key.

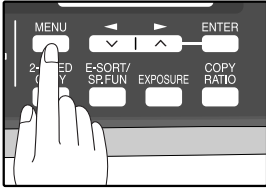

2 Press the [◀] key (◀) or [▶] key (▶) until "4:USER PROGRAM" appears, and then press the [ENTER] key.

Selection

"4:USER PROGRAM"

3 Press the [◀] key (◀) or [▶] key (▶) until "5:# OF RINGS (MANUAL)" appears, and then press the [ENTER] key.

Selection

"5:# OF RINGS (MANUAL)"

4 Press a numeric key to select the number of rings.

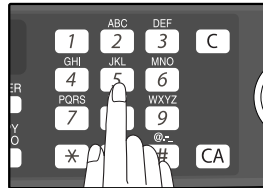

Select the number of rings you would like to use (0 to 9).

5 Press the [ENTER] key.

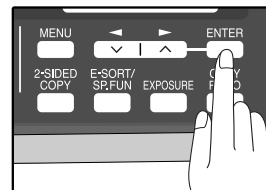

6 Press the [MENU] key.

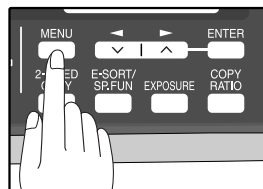

Press the [MENU] key to exit.

SELECTING THE RECEPTION PAPER SIZE

Set the size of paper to be used to print received faxes. A size setting other than "A4", "8.5x11", or "8.5x14" is regarded as out of paper. To set the paper size, see "LOADING PAPER" in the Operation Manual (for general information).

SETTING THE TRAY SELECTION (when the 250-sheet paper feed unit is installed)

Follow the steps below to select the paper tray for received faxes.

1 Press the [MENU] key.

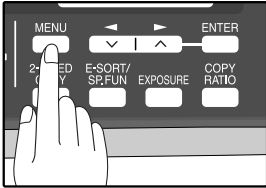

2 Press the [◀] key (◀) or [▶] key (▶) until "4:USER PROGRAM" appears, and then press the [ENTER] key.

Selection

"4:USER PROGRAM"

3 Press the [◀] key (◀) or [▶] key (▶) until "25:TRAY SELECTION" appears, and then press the [ENTER] key.

Selection

"25:TRAY SELECTION"



Note Select "24: TRAY SELECTION" when the AR-208S is used.

4 Press the [◀] key (◀) or [▶] key (▶) to select the tray selection.

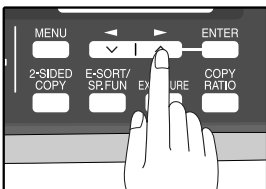

The selections are as follows:

- 1:AUTO
- 2:TRAY 1
- 3:TRAY 2

5 Press the [ENTER] key.

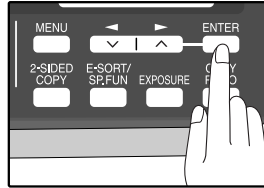

6 Press the [MENU] key.

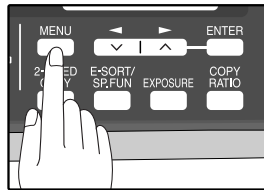

Press the [MENU] key to exit.

SETTING THE DIAL MODE

The machine can be used with both touch-tone and pulse telephone lines. Touch-tone uses tones of different pitches for each numeric key, while pulse lines use a series of pulses. Your machine must be set to match the kind of telephone line you are using: touch-tone or pulse.

1 Press the [MENU] key.

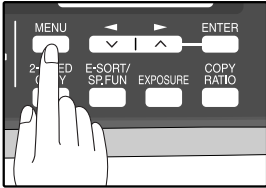

6 Press the [MENU] key.

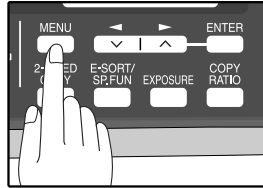

Press the [MENU] key to exit.

2 Press the [◀] key (◀) or [▶] key (▶) until "4:USER PROGRAM" appears, and then press the [ENTER] key.

Selection

"4:USER PROGRAM"

3 Press the [◀] key (◀) or [▶] key (▶) until "20:DIAL MODE" appears, and then press the [ENTER] key.

Selection

"20:DIAL MODE"

4 Press the [◀] key (◀) or [▶] key (▶) to select the dial mode.

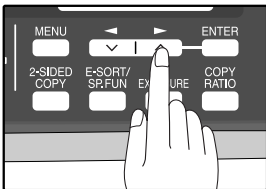

The selections are as follows:
1:TONE
2:PULSE

5 Press the [ENTER] key.

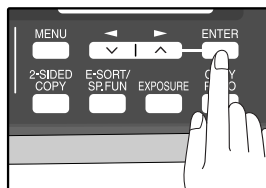

SETTING THE NUMBER OF RECALL TIMES

The machine will automatically reattempt transmission when a transmission is not successful because the line is busy or a communication error occurs. This setting is used to select the number of recall attempts that will be made.



- If a transmission is still not successful after the set number of recall attempts is made, a report will print and the document will be cleared from memory.
- If a communication error occurs because the memory becomes full during transmission, no recall attempts will be made.
- Recall attempts for a direct transmission will only be made when the RSPF is used. Recall attempts will not be made when the document glass is used.
- When the machine is waiting to make a recall attempt for a direct transmission, other operations such as storing a transmission or selecting a function cannot be performed.

When the line is busy

You can select the number of recall attempts made when the line is busy.
If "00" is entered, the machine will not make any recall attempts.

1 Press the [MENU] key.

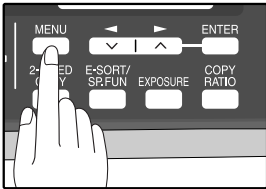

5 Press the [ENTER] key.

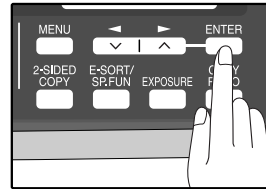

2 Press the [◀] key (◀) or [▶] key (▶) until "4:USER PROGRAM" appears, and then press the [ENTER] key.

Selection

"4:USER PROGRAM"

6 Press the [MENU] key.

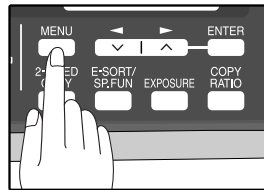

Press the [MENU] key to exit.

3 Press the [◀] key (◀) or [▶] key (▶) until "8:RECALL TIMES BUSY" appears, and then press the [ENTER] key.

Selection

"8:RECALL TIMES BUSY"

4 Press the numeric keys to select the number of recall attempts.



Enter the number of recall times ("00" to "14").

When a communication error occurs

You can select the number of recall attempts made when a communication error occurs. If "0" is entered, the machine will not make any recall attempts.

1 Press the [MENU] key.

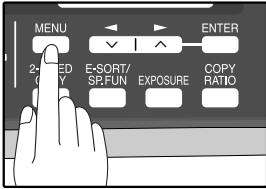

2 Press the [◀] key (◁) or [▶] key (▷) until "4:USER PROGRAM" appears, and then press the [ENTER] key.

Selection

"4:USER PROGRAM"

3 Press the [◀] key (◁) or [▶] key (▷) until "9:RECALL TIMES ERR" appears, and then press the [ENTER] key.

Selection

"9:RECALL TIMES ERR"

4 Press the numeric keys to select the number of recall attempts.



Enter the number of recall times ("0" or "1").

5 Press the [ENTER] key.

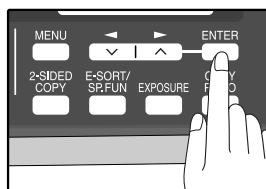

6 Press the [MENU] key.

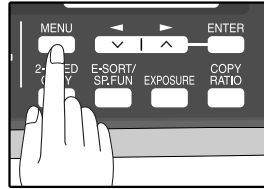

Press the [MENU] key to exit.

SETTING THE RECALL INTERVAL

The machine will automatically reattempt transmission when a transmission is not successful because the line is busy or a communication error occurs. This setting is used to select the interval between recall attempts.



- If a transmission is still not successful after the set number of recall attempts is made, a report will print and the document will be cleared from memory.
- If a communication error occurs because the memory becomes full during transmission, no recall attempts will be made.
- Recall attempts for a direct transmission will only be made when the RSPF is used. Recall attempts will not be made when the document glass is used.
- When the machine is waiting to make a recall attempt for a direct transmission, other operations such as storing a transmission or selecting a function cannot be performed.

When the line is busy

You can select the interval between recall attempts when the line is busy. An interval from 1 to 15 minutes can be selected.

1 Press the [MENU] key.

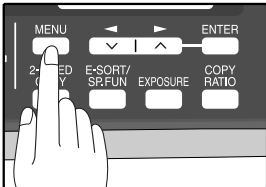

2 Press the [◀] key (◀) or [▶] key (▶) until "4:USER PROGRAM" appears, and then press the [ENTER] key.

Selection

"4:USER PROGRAM"

3 Press the [◀] key (◀) or [▶] key (▶) until "10:RECALL INT. BUSY" appears, and then press the [ENTER] key.

Selection

"10:RECALL INT. BUSY"

4 Press the numeric keys to select the recall interval.

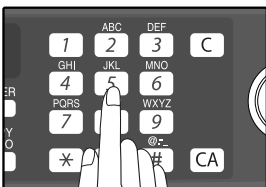

Enter the recall interval ("01" to "15").

5 Press the [ENTER] key.

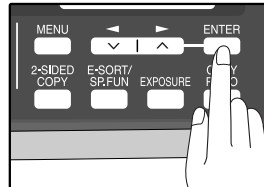

6 Press the [MENU] key.

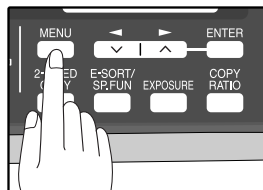

Press the [MENU] key to exit.

When a communication error occurs

You can select the interval between recall attempts when a communication error occurs. An interval from 0 to 15 minutes can be selected. If the recall interval is set to 0 minutes, the machine will immediately call again after breaking the connection due to the communication error.

1 Press the [MENU] key.

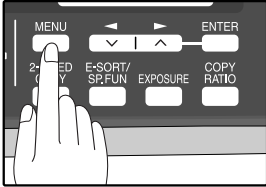

2 Press the [◀] key (◀) or [▶] key (▶) until "4:USER PROGRAM" appears, and then press the [ENTER] key.

Selection

"4:USER PROGRAM"

3 Press the [◀] key (◀) or [▶] key (▶) until "11:RECALL INT. ERR" appears, and then press the [ENTER] key.

Selection

"11:RECALL INT. ERR"

4 Press the numeric keys to select the recall interval.



Enter the recall interval ("00" to "15").

5 Press the [ENTER] key.

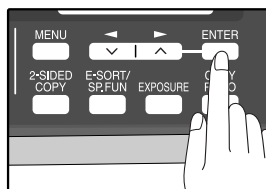

6 Press the [MENU] key.

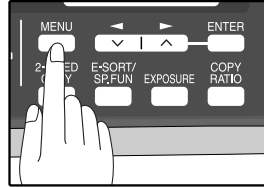

Press the [MENU] key to exit.

SETTING THE INDEX FUNCTION

You can print an index mark along the edge of the pages in each job. This makes it easy to separate different jobs on the output tray.

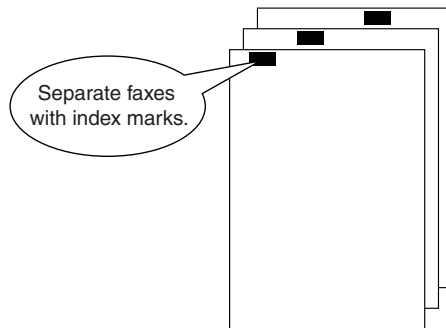

Use the following procedure to set the index function:

1 Press the [MENU] key.

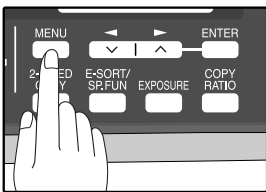

2 Press the [◀] key () or [▶] key () until "4:USER PROGRAM" appears, and then press the [ENTER] key.

Selection

"4:USER PROGRAM"

3 Press the [◀] key () or [▶] key () until "22:INDEX PRINT" appears, and then press the [ENTER] key.

Selection

"22:INDEX PRINT"

4 Press the [◀] key () or [▶] key () to select "1:ON" or "2:OFF".

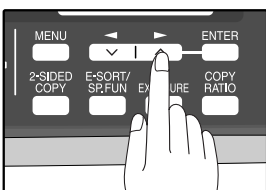

Select "1:ON" to enable the function.
Select "2:OFF" to disable the function.

5 Press the [ENTER] key.

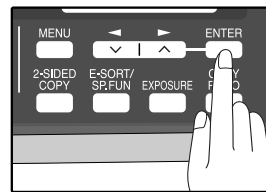

6 Press the [MENU] key.

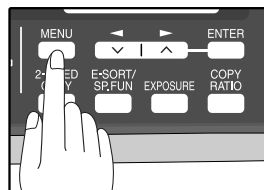

Press the [MENU] key to exit.

SETTING RESOLUTION PRIORITY

For most faxing jobs, you will most likely want to specify the resolution. However, you can also set a default resolution when no setting is made using the [RESOLUTION] key.

To turn on this function, follow the procedure below:

1 Press the [MENU] key.

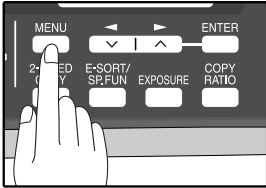

6 Press the [MENU] key.

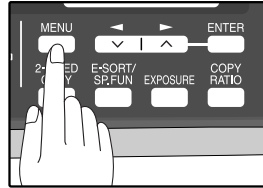

Press the [MENU] key to exit.

2 Press the [◀] key (◀) or [▶] key (▶) until "4:USER PROGRAM" appears, and then press the [ENTER] key.

Selection

"4:USER PROGRAM"

3 Press the [◀] key (◀) or [▶] key (▶) until "3:RESO. PRIORITY" appears, and then press the [ENTER] key.

Selection

"3:RESO. PRIORITY"

4 Press the [◀] key (◀) or [▶] key (▶) to select the transmission resolution.

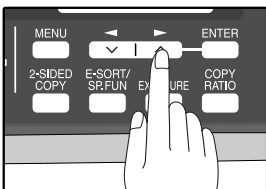

The selections are as follows:

- 1:STANDARD
- 2:FINE
- 3:SUPER FINE

5 Press the [ENTER] key.

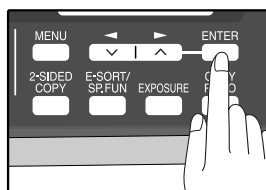

SETTING UP THE MACHINE FOR USE WITH A PC MODEM

The machine is set to automatically begin reception if you pick up from an extension telephone and the machine detects a fax tone. However, if you are using a modem on the same line, you must deactivate this function: otherwise the machine will mistakenly attempt to receive the transmission from your computer. To turn off the Fax Signal Receive function, follow the procedure below.



If you turn off the Fax Signal Receive function, be sure to activate the Remote Reception function. See "USING THE REMOTE RECEPTION FUNCTION" on page 39 for details on how to do this.

1 Press the [MENU] key.

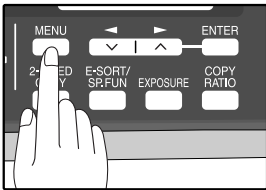

2 Press the [◀] key (▼) or [▶] key (▲) until "4:USER PROGRAM" appears, and then press the [ENTER] key.

Selection

"4:USER PROGRAM"

3 Press the [◀] key (▼) or [▶] key (▲) until "15:FAX SIGNAL RCV" appears, and then press the [ENTER] key.

Selection

"15:FAX SIGNAL RCV"

4 Press the [◀] key (▼) or [▶] key (▲) to select "1:ON" or "2:OFF".

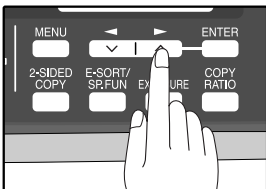

Select "1:ON" to enable the function.
Select "2:OFF" to disable the function.

5 Press the [ENTER] key.

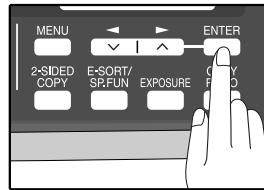

6 Press the [MENU] key.

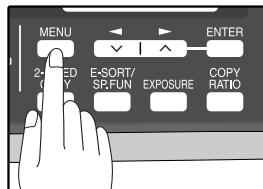

Press the [MENU] key to exit.

USING THE REMOTE RECEPTION FUNCTION

The machine's Remote Reception feature is designed to allow you to activate fax reception from an extension telephone. The Remote Reception function operates even when the FAX Signal Receive function is turned off. See "SETTING UP THE MACHINE FOR USE WITH A PC MODEM" on page 38. When you hear the fax tone, simply press the one-digit Fax Remote Number (Factory setting: 5) and * * *. Follow the procedure below to use this feature.



If you are not using a PC modem on the same line as your machine, and have not turned off the Fax Signal Receive function, you do not need to make any changes to the Remote Reception function. Simply use the factory settings. The machine will automatically take over the line should you answer from the extension phone and a fax tone is detected.

Turning on Remote Reception:

1 Press the [MENU] key.

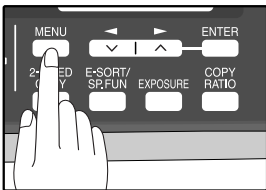

2 Press the [◀] key (◀) or [▶] key (▶) until "4:USER PROGRAM" appears, and then press the [ENTER] key.

Selection

"4:USER PROGRAM"

3 Press the [◀] key (◀) or [▶] key (▶) until "14:REMOTE RECEPTION" appears, and then press the [ENTER] key.

Selection

"14:REMOTE RECEPTION"

4 Press the [◀] key (◀) or [▶] key (▶) to select "1:ON" or "2:OFF".

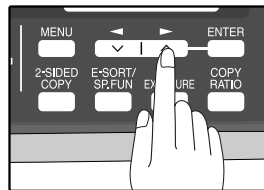

5 Press the [ENTER] key.

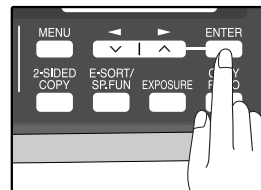

6 Press the [MENU] key.

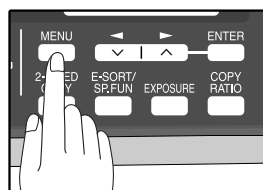

Press the [MENU] key to exit.

2

Setting a Fax Remote Number:

1 Press the [MENU] key.

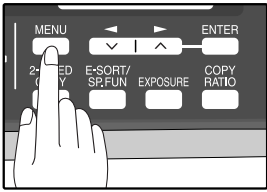

2 Press the [◀] key (⏪) or [▶] key (⏩) until "4:USER PROGRAM" appears, and then press the [ENTER] key.

Selection

"4:USER PROGRAM"

3 Press the [◀] key (⏪) or [▶] key (⏩) until "13:FAX REMOTE NUMBER" appears, and then press the [ENTER] key.

Selection

"13:FAX REMOTE NUMBER"

4 Press a numeric key to enter the Fax Remote Number.



Enter the number you would like to use as the Fax Remote Number ("0" to "9").

5 Press the [ENTER] key.

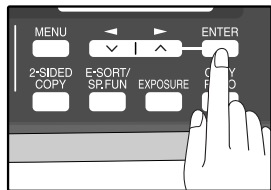

6 Press the [MENU] key.

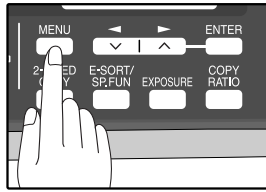

Press the [MENU] key to exit.

DISTINCTIVE RINGING

Distinctive ringing is a service offered by some telephone companies that allows you to use up to six different telephone numbers, each with a distinctive ringing pattern, on your regular single line. If you subscribe to a distinctive ringing service, you can set your fax to automatically answer when it detects one of these ringing patterns, and use the number corresponding to that pattern as an exclusive fax number.

Important:

- To use distinctive ringing, you must subscribe to your phone company's distinctive ringing service. Do not use this setting if you do not subscribe to a distinctive ringing service.

When using this feature, you must set the reception mode of your machine to AUTO (See "SELECTING THE RECEPTION MODE" (p.27)). When your designated fax number is dialed, the machine will automatically answer and begin reception. Note that other devices you have connected on the same line will also ring until the machine answers. If one of your other numbers is dialed, the machine will neither ring nor answer.

To use distinctive ringing, select the ringing pattern to which you want your machine to answer, as shown below.

The selections for ringing are:

1. OFF: Answers all ringing patterns (This turns distinctive ringing off.)
2. STANDARD: Your machine normal ringing pattern
3. PATTERN 1: Two short rings
4. PATTERN 2: One short, one long, and one short ring
5. PATTERN 3: Three short rings
6. PATTERN 4: Three rings
7. PATTERN 5: Two rings

Use the following procedure to change the ringing pattern.

1 Press the [MENU] key.

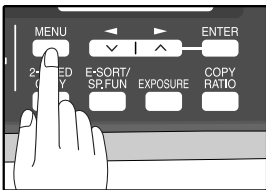

2 Press the [◀] key (◀) or [▶] key (▶) until "4:USER PROGRAM" appears, and then press the [ENTER] key.

Selection

"4:USER PROGRAM"

3 Press the [◀] key (◀) or [▶] key (▶) until "21:DISTINCTIVE RING" appears, and then press the [ENTER] key.

Selection

"21:DISTINCTIVE RING"

4 Press the [◀] key (◀) or [▶] key (▶) to select a ringing pattern.

Select a ringing pattern by scrolling through them with the arrow keys in the order of the above list.

5 Press the [ENTER] key.

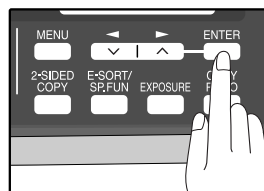

6 Press the [MENU] key.

Press the [MENU] key to exit.

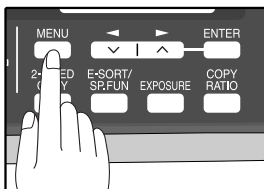

STORING NUMBERS FOR AUTOMATIC DIALING

Automatic Dialing is a quick and convenient way to dial by using only a Rapid key (Rapid Key Dialing), or pressing the [SPEED/SEARCH] key and select the SPEED and entering a two digit number (Speed Dialing).

To use Automatic Dialing, you must first store the full number. The way you store it depends on whether you want to use it for Rapid Key Dialing or Speed Dialing:

Storing numbers

Use the following procedure to store numbers for Rapid Key Dialing or Speed Dialing:

1 Press the [MENU] key.

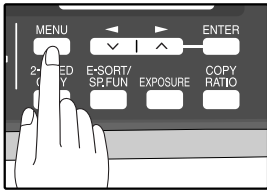

2 Press the [◀] key (⏪) or [▶] key (⏩) until "2:ENTRY MODE" appears, and then press the [ENTER] key.

Selection

"2:ENTRY MODE"

3 Press the [◀] key (⏪) or [▶] key (⏩) until "1:FAX NUMBER" appears, and then press the [ENTER] key.

Selection

"1:FAX NUMBER"

4 Press the [◀] key (⏪) or [▶] key (⏩) to select the type of auto-dial number that you wish to program and then press the [ENTER] key.

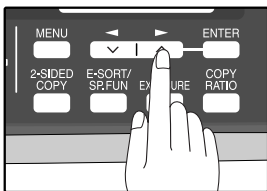

To program a Rapid Key, select "1:RAPID KEY".
To program a Speed Dial number, select "2:SPEED #".

5 Press the [◀] key (⏪) or [▶] key (⏩) to select "1:SET" and then press the [ENTER] key.

Selection

"1:SET"

6 Press the Rapid Key or enter the Speed Dial number that you wish to program.

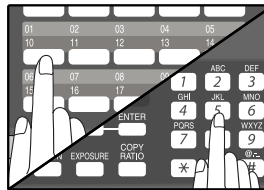

To program a Rapid Key, press a Rapid key ("01" to "18").

To program a Speed Dial number, press two numeric keys ("00" to "99") and then press the [ENTER] key.

7 Enter the fax number with the numeric keys.

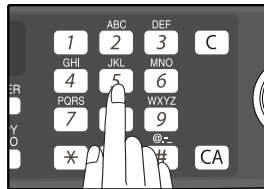

Enter the fax number (maximum of 40 digits including pauses) using the numeric keys.

8 Press the [ENTER] key.

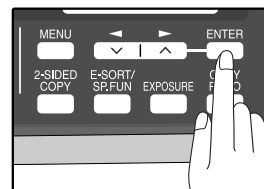

9 Enter the name of the destination with the numeric keys.



Enter the name of the location or party by pressing numeric keys as described in "HOW TO ENTER CHARACTERS" on page 20 (maximum of 20 characters). If you do not want to enter a name, skip this step.

10 Press the [ENTER] key.

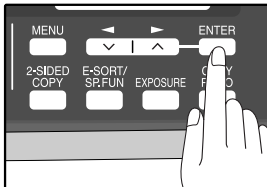

11 Press the [◀] key (◀) or [▶] key (▶) to select a Chain Dial setting.

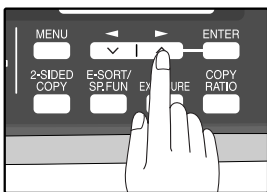

If you wish to set the number as a Chain Dial number, select "1:SET". Otherwise, select "2:CANCEL". (See "CHAIN DIALING" (p.60))

If the number is not set as a chain dial number, the communication speed and international communication mode cannot be selected. Press the [ENTER] key and go to step 17.

12 Press the [ENTER] key.

13 Press the [◀] key (◀) or [▶] key (▶) to select the communication speed.

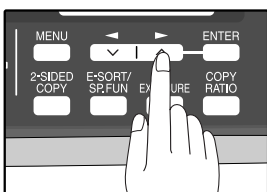

The selections are as follows:
 1:33600bps
 2:14400bps
 3:9600bps
 4:4800bps



For international dialing, if you find that line noise necessitates a slower transmission speed, set the appropriate transmission speed. If you are not sure if a slower speed is required, set the speed normally.

14 Press the [ENTER] key.

15 Press the [◀] key (◀) or [▶] key (▶) to select the international communication mode.

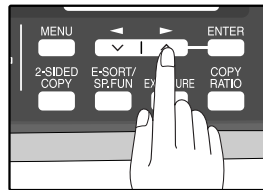

The selections are as follows:

- 1:NO
- 2:MODE 1
- 3:MODE 2
- 4:MODE 3



Sometimes when faxing internationally, line noise can cause the transmission to stop momentarily. To reduce these delays, choose the appropriate international transmission mode.

2

16 Press the [ENTER] key.

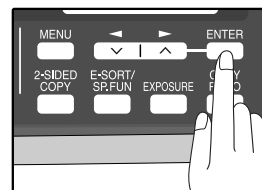

Return to Step 5 to store another number.

17 Press the [MENU] key.

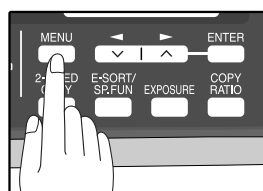

Press the [MENU] key to exit.

If the number is a Rapid key number, you can write the name on the label above the appropriate Rapid key.



You may need to add a pause between certain digits in the number to allow time for connection. For example, if you are on a PBX telephone system that requires an access number, such as "9", to be dialed to access an outside line, you will need to enter a pause between the access number and the fax number of the other party. Pauses are entered by pressing the [REDIAL/PAUSE] key (2 seconds per pause). If necessary, several pauses can be entered in a row.

Use the following procedure to clear numbers:

1 Press the [MENU] key.

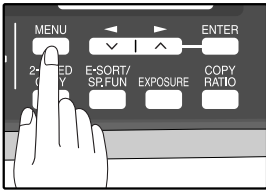

2 Press the [◀] key (▼) or [▶] key (▲) until "2:ENTRY MODE" appears, and then press the [ENTER] key.

Selection

"2:ENTRY MODE"

3 Press the [◀] key (▼) or [▶] key (▲) until "1:FAX NUMBER" appears, and then press the [ENTER] key.

Selection

"1:FAX NUMBER"

4 Press the [◀] key (▼) or [▶] key (▲) to select the type of auto-dial number that you wish to delete.

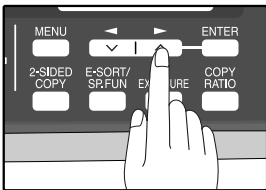

To delete a Rapid Key, select "1:RAPID KEY". To delete a Speed Dial number, select "2:SPEED #".

5 Press the [◀] key (▼) or [▶] key (▲) until "2:CLEAR" appears, and then press the [ENTER] key.

Selection

"2:CLEAR"

6 Enter the Rapid Key or Speed Dial number that you wish to delete.

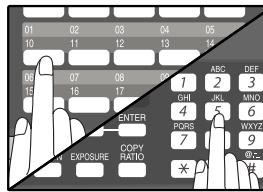

To delete a Rapid Key, press the appropriate Rapid key.

To delete a Speed Dial number, enter the 2-digit number with the numeric keys and then press the [ENTER] key.

7 Press the [ENTER] key.

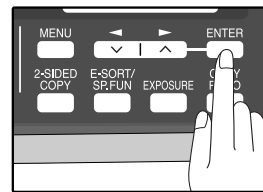

Return to Step 5 to clear another number.

8 Press the [MENU] key.

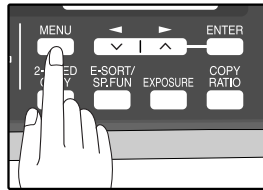

Press the [MENU] key a number of times until you exit.



- A Rapid Key or Speed Dial number cannot be deleted if it has been stored in a Group Key.
- A Rapid Key or Speed Dial number cannot be deleted if it is being used for a transmission that has been stored or is in progress.

STORING NUMBERS UNDER GROUP KEYS

Group keys allow you to dial a group of fax numbers by simply pressing the appropriate Group key once. They are convenient for the Broadcasting function, which is used to transmit an original to a group of fax machines.

All Rapid keys can be programmed as Group keys. To program or clear a group key, follow the steps below. Note that one key cannot be programmed as both a Rapid key and a Group key at the same time.

- Up to 100 fax numbers can be stored in one Group key.
- Rapid Keys, Speed Dial numbers, and numbers directly entered with the numeric keys can be stored in Group Keys.

Storing/adding numbers in a Group Key:

1 Press the [MENU] key.

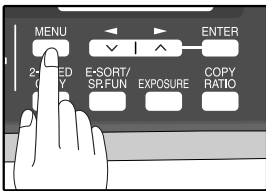

2 Press the [◀] key (◀) or [▶] key (▶) until "2:ENTRY MODE" appears, and then press the [ENTER] key.

Selection

"2:ENTRY MODE"

3 Press the [◀] key (◀) or [▶] key (▶) until "1:FAX NUMBER" appears, and then press the [ENTER] key.

Selection

"1:FAX NUMBER"

4 Press the [◀] key (◀) or [▶] key (▶) until "3:GROUP KEY" appears, and then press the [ENTER] key.

Selection

"3:GROUP KEY"

5 Press the [◀] key (◀) or [▶] key (▶) to select "1:SET" and then press the [ENTER] key.

Selection

"1:SET"

6 Press the Rapid key you wish to use as a Group key .

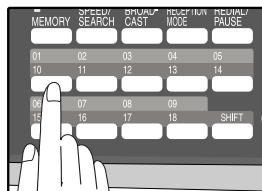

To add numbers:
After pressing the Group Key, press the [◀] key (◀) or [▶] key (▶) to select "1:YES" and then press the [ENTER] key.

7 Enter the numbers that you wish to store in the Group Key.

Enter the fax numbers using any of the following methods:

- Press a Rapid Key and then press the [ENTER] key.
- Enter a Speed Dial number with the numeric keys and then press the [ENTER] key.
- Enter a number with the numeric keys and then press the [ENTER] key.



- One Group Key cannot be stored in another Group Key.
- A message will appear if you select a Rapid Key or Speed Dial number that is already stored in another Group Key.

8 Press the [ENTER] key.

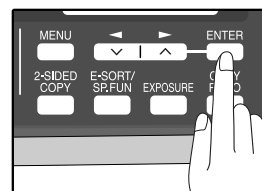

2

9 Enter a name for the Group Key with the numeric keys.

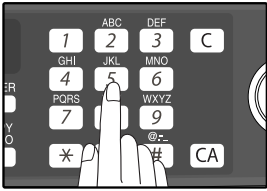

Enter the name of the group by pressing numeric keys as described in "HOW TO ENTER CHARACTERS" on page 20 (maximum of 20 characters). If you do not want to enter a name, skip this step.

To add numbers:
The entered name appears. Edit the name if you need to make a change.

10 Press the [ENTER] key.

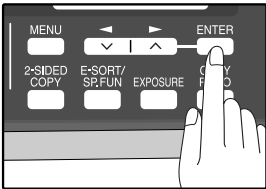

Return to Step 7 to program another Group key.

11 Press the [MENU] key.

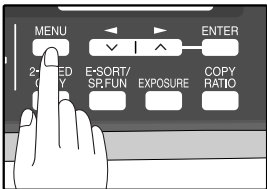

Press the [MENU] key to exit.

Deleting numbers from Group Keys:

1 Press the [MENU] key.

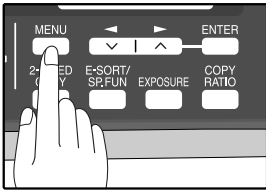

2 Press the [◀] key (▼) or [▶] key (▲) until "2:ENTRY MODE" appears, and then press the [ENTER] key.

Selection

"2:ENTRY MODE"

3 Press the [◀] key (▼) or [▶] key (▲) until "1:FAX NUMBER" appears, and then press the [ENTER] key.

Selection

"1:FAX NUMBER"

4 Press the [◀] key (▼) or [▶] key (▲) until "3:GROUP KEY" appears, and then press the [ENTER] key.

Selection

"3:GROUP KEY"

5 Press the [◀] key (▼) or [▶] key (▲) to select "2:CLEAR" and then press the [ENTER] key.

Selection

"2:CLEAR"

To delete a Group, press the appropriate Group key.

6 Press the [◀] key (▼) or [▶] key (▲) to select "1:FAX #" and then press the [ENTER] key.

Selection

"1:FAX #"

To delete all numbers from the Group Key:
Select "2:GROUP" and press the [ENTER] key.

7 Enter the numbers that you wish to delete.

Enter the fax numbers using any of the following methods:

- Press a Rapid Key.
- Enter a Speed Dial number with the numeric keys.
- Enter a number with the numeric keys.

8 Press the [ENTER] key.

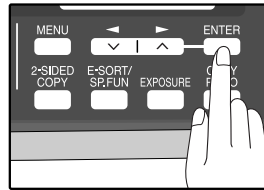

9 To exit, press the [◀] key (▼) or [▶] key (▲) to select "2:END".

Selection

"2:END"

To program another Group Key, select "1:CONTINUE", press the [ENTER] key, and return to step 7.

10 Press the [ENTER] key.

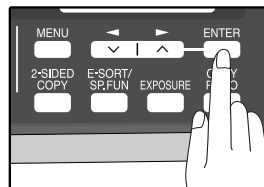

11 Press the [MENU] key.

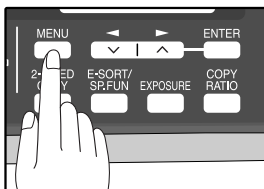

Press the [MENU] key to exit.

USING THE MACHINE WITH AN ANSWERING MACHINE

QUIET DETECT TIME

Quiet Detect Time is the function that enables the machine to be used along with an answering machine for both phone messages and faxes. After the answering machine has answered, any duration of silence longer than a certain threshold time will prompt the machine to take over the line and prepare to receive a fax. The Quiet Detect Time can be set from 00 to 10 seconds, following the procedure below.

1 Press the [MENU] key.

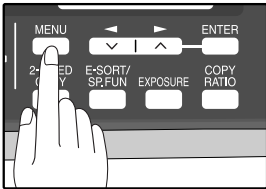

2 Press the [◀] key (◀) or [▶] key (▶) until "6:A.M. MODE" appears, and then press the [ENTER] key.

Selection

"6:A.M. MODE"

3 Press the [◀] key (◀) or [▶] key (▶) until "1:QUIET DETECT TIME" appears, and then press the [ENTER] key.

Selection

"1:QUIET DETECT TIME"

4 Enter the Quiet Detect Time with the numeric keys.

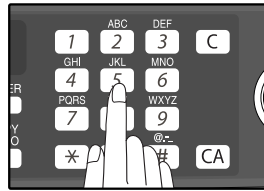

Enter the Quiet Detect Time in seconds, from 00 to 10. (setting "00" turns off Quiet Detect Time)

5 Press the [ENTER] key.

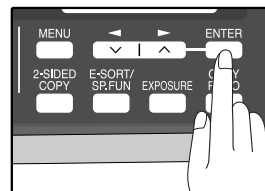

6 Press the [MENU] key.

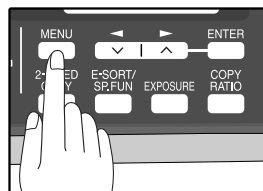

Press the [MENU] key to exit.



- The machine has been set at the factory for a Quiet Detect Time of 5 seconds, which gives the best performance for most answering machines. However, you may have to adjust the Quiet Detect Time depending on your answering machine's disconnect time, the time before the machine disconnects the line after a period of silence. If your machine has a short disconnect time, you may have to shorten the Quiet Detect Time. However, if the machine is interrupting callers in the middle of messages, you should set a longer Quiet Detect Time.
- If there is a pause at the end of your answering machine message, make sure that the Quiet Detect Time is longer than this pause.
- Setting Quiet Detect Time to 00 turns the function off. However, the machine will not be able to receive faxes sent using manual dialing (picking up the receiver, dialing the number, and pressing the [START] key (⊙) when the fax tone is heard).
- If your answering machine is set to answer calls after more rings than the machine's number of rings setting, the machine will always answer first and thereby prevent callers from leaving messages in the answering machine.

If Quiet Detect Time is not working properly...

With some answering machines, there is simply no Quiet Detect Time that will allow both reception of faxes and uninterrupted voice messages. Even in this case, however, you can set up the machine to receive both phone and fax messages from callers on touch-tone lines. Follow this procedure:

1. Set the Quiet Detect Time to 00.
2. Alter your phone message to tell callers that they can send a fax by pressing the Remote Reception Number (factory set to 5), followed by the " * " key twice.

ANSWERING MACHINE BACKUP

There may be times when the tape on your answering machine becomes full, or when the answering machine itself malfunctions. It is still possible to receive faxes even under these conditions, by turning on the Auto Receive function. The machine will automatically answer all calls after five rings. To use this function, follow the procedure below.

1 Press the [MENU] key.

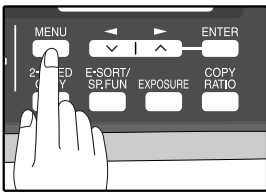

2 Press the [◀] key (◀) or [▶] key (▶) until "6:A.M. MODE" appears, and then press the [ENTER] key.

Selection

"6:A.M. MODE"

3 Press the [◀] key (◀) or [▶] key (▶) until "2:AUTO RECEIVE" appears, and then press the [ENTER] key.

Selection

"2:AUTO RECEIVE"

4 Press the [◀] key (◀) or [▶] key (▶) to select "1:ON" or "2:OFF".

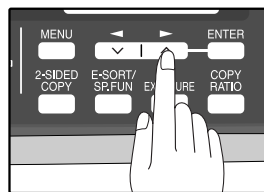

Select "1:ON" to enable the function.
Select "2:OFF" to disable the function.

5 Press the [ENTER] key.

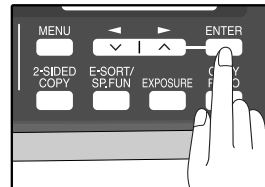

6 Press the [MENU] key.

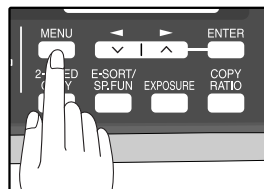

Press the [MENU] key to exit.



If you are using Auto Receive, make sure that your answering machine is set to answer on four rings or less. Otherwise, the machine will take over all calls, preventing callers from leaving voice messages.

ORIGINALS SUITABLE FOR FAXING

Make sure that the originals you want to fax meet specifications and guidelines listed in this section.

SIZE AND WEIGHT

The size and weight of originals that you can load in the RSPF depend on whether you load one sheet at a time or several sheets at once.

When using the RSPF

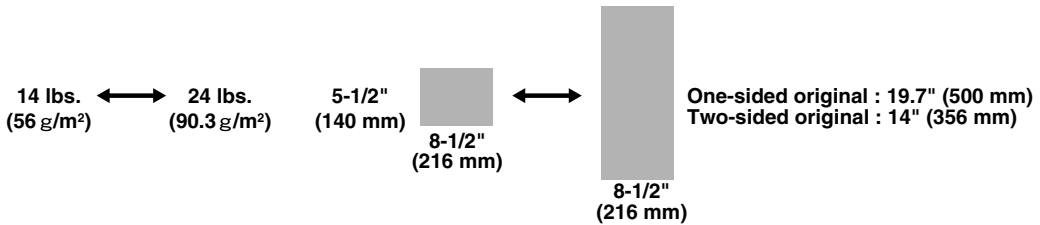

When feeding in a long original, grasp the original at the edges to guide it into the machine.

When using the document glass

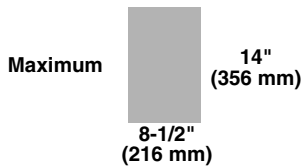

When you are using the faxing functions of the machine, your originals are, in effect, being scanned through the machine. The area of a original that is scanned by the machine while faxing is slightly smaller than the actual original size. Any text or graphics outside this area will not be scanned.

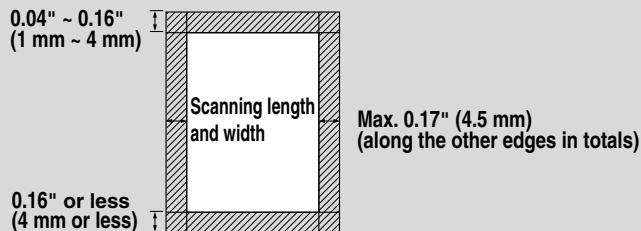

UNSUITABLE ORIGINALS

General guidelines:

- All clips, staples, and pins should be removed from originals before they are used. If these are not removed, they may damage the machine.
- Ink, glue, and correction fluid on originals must be completely dry before using the originals with the machine.
- Originals that are in some way dangerous to the internal mechanisms of the machine should not be used.
- When faxing, any writing on the originals that is yellow, yellowish-green, or light blue cannot be transmitted.

The following kinds of originals should not be used:

- Originals with a glossy coating
- Originals with static electricity
- Originals with tears, folds, or curls
- Originals that have become stuck together and cannot be easily separated
- Originals with holes, windows, or perforations
- Transparency films, tracing paper, or other transparencies
- Originals with plastic or metallic coatings



- SHARP does not accept any responsibility for the loss or damage of originals.
- Scanning an original that is longer than 500 mm will result in a misfeed.

The machine offers a range of sophisticated features that allow you to control image quality, reception mode, broadcasting, polling, and transmission priorities. Functions such as sending original(s) from memory and substituting reception into memory are possible, due to the large memory capacity.

SENDING ORIGINALS

SETTING THE ORIGINAL

This section describes setting original(s) in the RSPF or on the document glass.

When Using the RSPF:

1 Confirm that there are no original(s) on the document glass and that copying is not in progress, then gently close the RSPF.

2 Adjust the original guides to the width of your original(s).

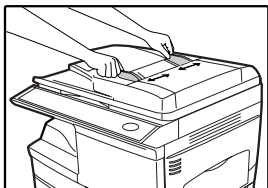

3 Place the original(s) face up and push it gently into the document feeder tray. The top edge of the original(s) should enter the fax first.

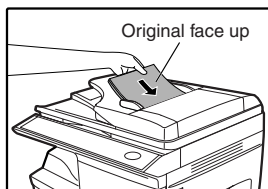

4 There are two ways to send the fax:

- To scan the original into memory, then dial and transmit, continue with the "DIALING AND TRANSMITTING" section. (p.59)
- To dial and transmit the original directly without first scanning it into memory, press the [MEMORY] key to make the [MEMORY] key indicator go off. Continue with the "DIALING AND TRANSMITTING" section. (p.59)

When placing the Original on the document glass:

1 Confirm that there are no original(s) in the RSPF, and open the RSPF.

2 Place the original face down on the document glass. Align the original according to the original scale in the illustration below. (Line up the center of the edge of the original with the (▶) mark.)

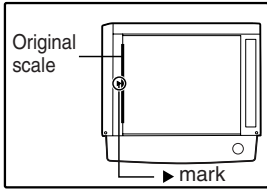

3 Gently close the RSPF.

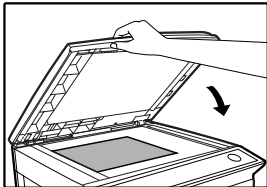

Note When using the document glass, do not set original(s) in the RSPF.

4 If needed, set the original size (p.54), resolution (p.55), and contrast (p.55). Continue with the "DIALING AND TRANSMITTING" (p.59) section.

5 Press the [START] key (⊙).

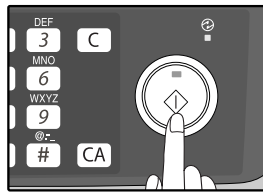

The set original size appears in the display and then scanning begins.

Note After the [START] key (⊙) is pressed, the set original size appears in the display.

(EX.)

READING	#001
8.5x11	100%

Make sure that the displayed size is the same as the actual original size. (The factory default setting for the original size is "8.5x11".) If the displayed size is not correct, press the [CLEAR ALL] key (CA) to stop operation and then change the original size setting. (See "ORIGINAL SIZE" (p.54)) When faxing from the document glass, if the size of the original is different from the specified size, part of the image may be cut off.

4

6 If you have more than one original to read into memory, place the next page, and press the [START] key (⊙) to read each page.

Go to step 7 after the last page has been scanned.

7 Press the [#] key.

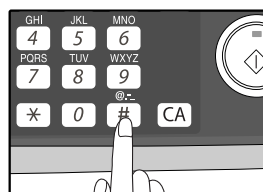

Transmission begins.

OPTIONAL TRANSMISSION SETTINGS

There are several transmission settings that you can make before dialing and transmitting an original.

ORIGINAL SIZE

The original size can be set to "8.5x11", "8.5x14", or "A4". The setting is only effective for one transmission. If desired, you can set a fixed original size that remains in effect for all transmissions.

1 Press the [MENU] key.

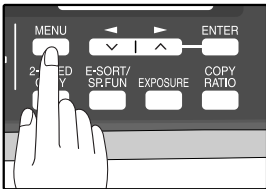

2 Press the [◀] key (◀) or [▶] key (▶) until "4:USER PROGRAM" appears, and then press the [ENTER] key.

Selection

"4:USER PROGRAM"

3 Press the [◀] key (◀) or [▶] key (▶) until "1:DOC. GLASS SIZE" appears, and then press the [ENTER] key.

Selection

"1:DOC. GLASS SIZE"

To set a fixed original size for all transmissions:
Press the [◀] key (◀) or [▶] key (▶) to select "2:FIXED DOC. SIZE".



To temporarily change the original size setting when faxing from the document glass, use the "1: DOC. GLASS SIZE" setting. To change the permanent original size setting, use the "2: FIXED DOC. SIZE" setting.

4 Press the [◀] key (◀) or [▶] key (▶) to select the original size.

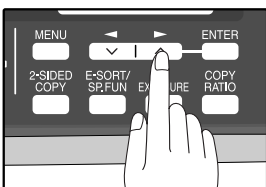

The selections are as follows:

- 1:8.5x11
- 2:8.5x14
- 3:A4

5 Press the [ENTER] key.

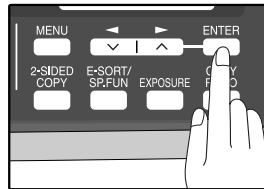

6 Press the [MENU] key.

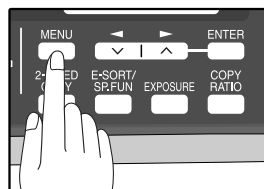

Press the [MENU] key to exit.

RESOLUTION

To do this, press the [RESOLUTION] key one or more times until the desired resolution settings appear in the display, and then press the [ENTER] key.

Your fax has five resolution settings:

- **STANDARD**

Use STANDARD for ordinary originals. This setting gives you the fastest transmission.

- **FINE**

Use FINE for improved reproduction, especially with originals containing small letters or fine drawings.

- **SUPER FINE**

Use SUPER FINE when you need the highest quality of reproduction.

- **FINE (HALF TONE)**

Use FINE (HALF TONE) if your original is a photograph or has gradations of color (such as a color original). This setting will produce a clearer image than Fine used alone.

- **S. FINE (HALF TONE)**

Use S.FINE (HALF TONE) if your original is a photograph or has gradations of color (such as a color original). This setting will produce a clearer image than Super fine used alone.

In order to transmit with FINE or SUPER FINE resolution, the receiving fax machine must also have that resolution. If it doesn't, the next best available setting will be used.

If you do not change the setting, the resolution set using the RESOLUTION PRIORITY (p.37) setting will be automatically selected.

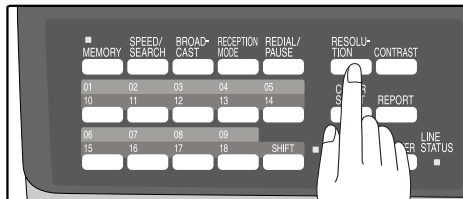

4

CONTRAST

The fax automatically controls the contrast, but you can also control it manually. To do this, press the [CONTRAST] key one or more times until the desired contrast settings appear in the display, and then press the [ENTER] key. The three contrast levels are MEDIUM, DARK, and LIGHT.

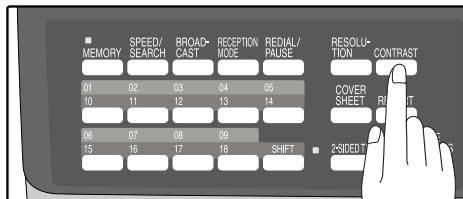

COVER SHEET

You can have your fax generate a cover sheet and send it as the last page of the transmission. The cover sheet includes the date and time, the sender's name and number, and the receiver's name and number if an automatic dialing number is used. The total number of pages sent is indicated on the bottom. One of five messages can also be added to the cover sheet.

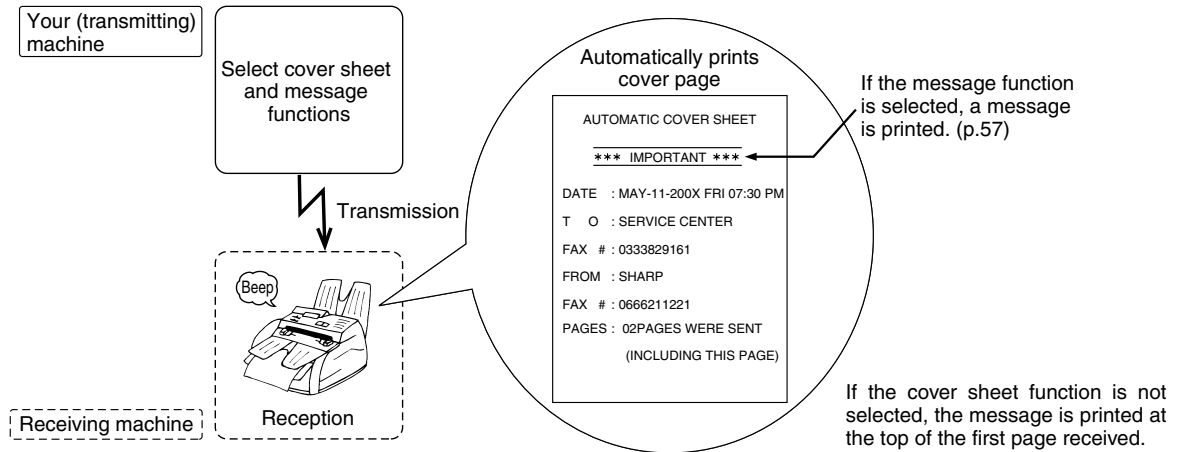

Note

- The receiver's name must be programmed in either the Rapid Key or Speed Dial function for it to appear on the Cover Sheet.
- The cover sheet function must be selected each time you wish to add a cover sheet to a fax transmission.
- To add a message to a cover sheet, the message must be selected using the message function.

To include a cover sheet with a transmission, follow these steps:

1 Press the [COVER SHEET] key until "1:COVER SHEET SET" appears, and then press the [ENTER] key.

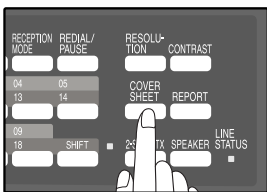

Selection

"1:COVER SHEET SET"

2 Press the [←] key () or [→] key () to select "1:ON" or "2:OFF".

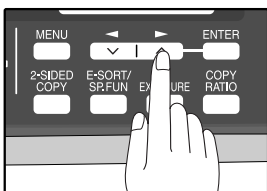

Select "1:ON" to enable the function.
Select "2:OFF" to disable the function.

3 Press the [ENTER] key.

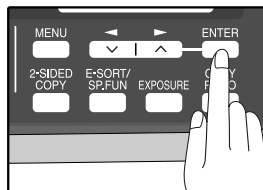

MESSAGE FUNCTION

One of the following messages can be selected: "CONFIDENTIAL", "PLS. DISTRIBUTE", "URGENT", "PLS. CALL BACK", "IMPORTANT".



If a message is selected when the cover sheet function is not used, the message will be added to the top of the first page of the fax.

To add a message to a cover sheet, follow these steps:

1 Press the [COVER SHEET] key.

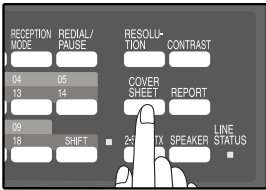

2 Press the [COVER SHEET] key until "2:TX MESSAGE SET" appears, and then press the [ENTER] key.

Selection

"2:TX MESSAGE SET"

3 Press the [◀] key (◀) or [▶] key (▶) to select a message.

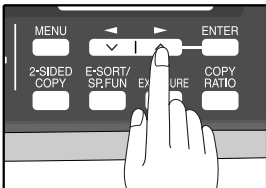

The selections are as follows:

- 1:NO MESSAGE
- 2:CONFIDENTIAL
- 3:PLS. DISTRIBUTE
- 4:URGENT
- 5:PLS. CALL BACK
- 6:IMPORTANT

If you do not wish to add a message, select "1:NO MESSAGE".

4 Press the [ENTER] key.

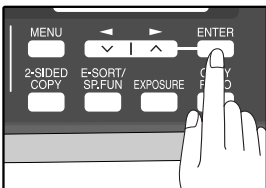

TWO-SIDED ORIGINAL TRANSMISSION FUNCTION

The RSPF can be used to automatically fax a two-sided original. If desired, the back of the original can be rotated 180° before transmission.



- The original must be placed in the RSPF when using the two-sided original transmission function. The document glass cannot be used.
- The two-sided original transmission function cannot be selected when direct transmission mode is selected. Likewise, direct transmission mode cannot be selected when the two-sided original transmission function is selected.

Follow these steps to fax a two-sided original:

1 Place the original(s) in the RSPF. (p.52)

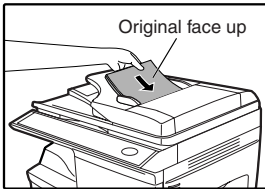

For the size and weight of two-sided originals that can be scanned using the RSPF, see page 50.

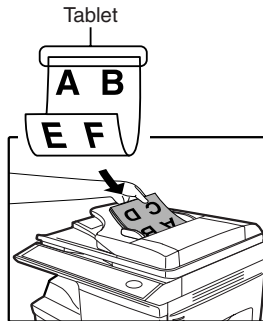

If you are faxing a two-sided tablet type original, select "ON (NON-ROTATE)".

2 Press the [2-SIDED TX] key until the appropriate setting appears.

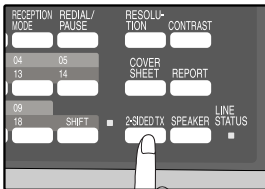

The selections are as follows:
 OFF
 ON (ROTATE)
 ON (NON-ROTATE)

To cancel this function, select "OFF".

3 Press the [ENTER] key.

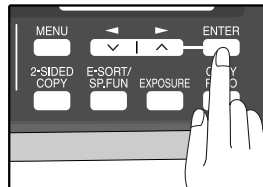

Select the setting according to the original type (booklet or tablet) as indicated below. If the setting is incorrect, every other page of the received fax will be inverted.

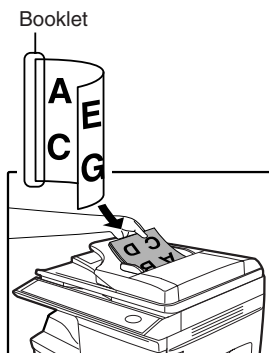

If you are faxing a two-sided booklet type original, select "ON (ROTATE)".

DIALING AND TRANSMITTING

Once you have set the original (either in the RSPF or on the document glass), and have selected the desired transmission settings, you are ready to dial the number of the receiving fax machine and transmit the original. You can choose from one of the several ways of dialing that best suit your needs.

DIRECT KEYPAD DIALING

If the number of the fax you want to reach is not a Rapid key or Speed Dial number, use Direct Keypad Dialing to manually enter it using the following procedure:

1 Confirm that you have correctly set the original in the RSPF or on the document glass. (See "SETTING THE ORIGINAL" (p.52))

2 Enter the number of the fax machine you want to send to by pressing the numeric keys.

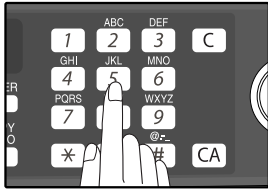

If it is not correct, press the [CLEAR] key (C) to backspace and clear one digit at a time, and then enter the correct number.

3 Check the display. If the number of the receiving machine is shown correctly, press the [START] key (⊙).

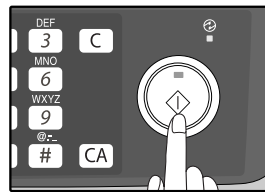

While "SENDING" is shown in the display, do not open the RSPF.

RAPID KEY DIALING

If the number you want to dial has been stored as a Rapid key number (See "STORING NUMBERS FOR AUTOMATIC DIALING" (p.42)), you can dial it by pressing the appropriate Rapid key as shown:

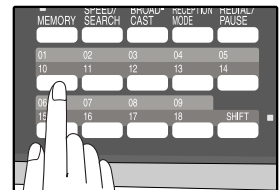

SPEED DIALING

If the number you want to dial has been stored as a Speed Dial number, you can dial it using the following procedure:

1 Press the [SPEED/SEARCH] key and then enter the two-digit number by pressing the numeric keys (See "STORING NUMBERS FOR AUTOMATIC DIALING" (p.42)).

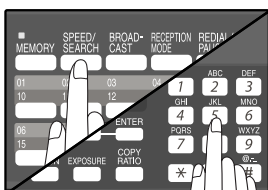

If it is not correct, press the [CLEAR] key (C) to backspace and clear two digit at a time, and then enter the correct number.

2 Press the [START] key (⊙) and check the name or number that appears in the display.



While "READING" is shown in the display, do not open the RSPF.

CHAIN DIALING

The Chain Dialing function allows you to combine a Rapid Key or Speed Dial number (See "STORING NUMBERS FOR AUTOMATIC DIALING" (p.42)) set for Chain Dialing with another Rapid Key, Speed Dial number, or number dialed with the numeric keys to dial one fax number up to 50 digits long. The following are some examples of how this can be done:

- Press Rapid Keys set for Chain Dialing in the correct order for the fax number that you wish to dial. For example, press Rapid Key 01 followed by Rapid Key 02. The final Rapid Key pressed for the fax number must not be set for Chain Dialing. Transmission will begin automatically when the final Rapid Key is pressed.
- Enter Speed Dial numbers set for Chain Dialing in the correct order for the fax number that you wish to dial. For example, press the [SPEED/SEARCH] key and [2] [2], followed by the [SPEED/SEARCH] key and [2] [7]. The final Speed Dial number entered for the fax number must not be set for Chain Dialing. Transmission will begin when the [START] key (Ⓢ) is pressed after the final Speed Dial number is entered.
- Enter the fax number that you wish to dial with the numeric keys. Press the [REDIAL/PAUSE] key to enter a pause and then enter the next number. Transmission will begin when the [START] key (Ⓢ) is pressed after the final number is entered.



- To use a Rapid Key or Speed Dial number for Chain Dialing, the Rapid Key or Speed Dial number must be set for Chain Dialing when it is stored (See "STORING NUMBERS FOR AUTOMATIC DIALING" (p.42)).
- When using Chain Dialing, the international communication setting of the final number entered is effective. International communication mode cannot be used if the final number is entered using a Rapid Key or Speed Dial number that does not have the setting enabled, or if the final number is entered with the numeric keys.

NORMAL DIALING USING THE [SPEAKER] KEY

When dialing normally with the [SPEAKER] key, press the [SPEAKER] key and dial using the numeric keys. You can hear the line and fax tones from the other machine through the speaker, allowing you to confirm the response of the other machine.

1 Set the original in the RSPF and press the [SPEAKER] key. (See "SETTING THE ORIGINAL" (p.52))

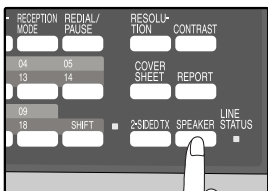

To adjust the volume, press the left and [◀] key (◀) or [▶] key (▶).

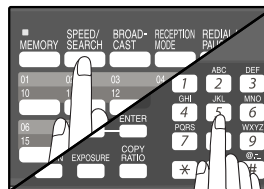

Dialing with a Speed Dial number and then press the [ENTER] key or [START] key (Ⓢ).

2 Dial the fax number of the receiving machine.



Dialing with the numeric keys.

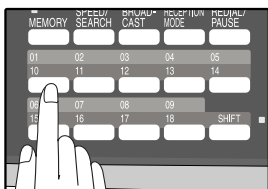

Dialing with a Rapid Key.

3 When you hear the fax reception tone of the other machine, press the [START] key (Ⓢ).

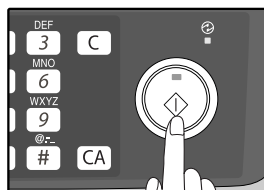

4 Press the [◀] key (◀) or [▶] key (▶) to select "1:SEND", and then press the [ENTER] key or [START] key (Ⓢ).

USING THE SEARCH KEY

If you do not remember the Rapid key or Speed Dial number in which you have stored a particular fax number, you can search for the number by following the steps below:

1 Press the [SPEED/SEARCH] key twice.

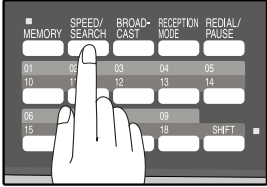

2 Enter the first letter of the stored name by pressing the appropriate numeric key (the key below the marked letter) until the letter appears in the display. If the name begins with a special character or number, press [1] key.

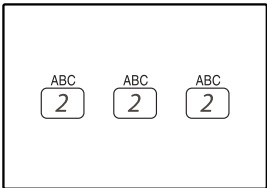

If you do not remember the first letter, go to Step 3 and scroll through the list from the beginning.

3 Press the [ENTER] key.

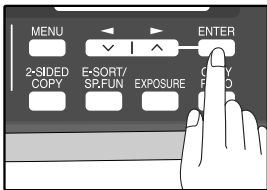

4 Press the [◀] key (◀) or [▶] key (▶) to scroll through the names. Stop when the desired name appears in the display.

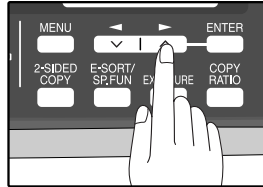

5 Press the [START] key (⊙). The original will be automatically transmitted once the connection is made.

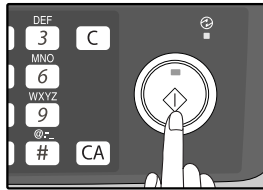

4

REDIALING

You can send a fax to the number you last dialed, you can redialing it using the following procedure:

1 Press the [REDIAL/PAUSE] key.

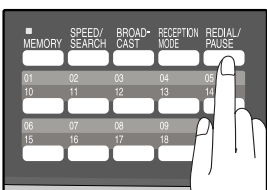

2 Press the [START] key (⊙).



IF THE MEMORY BECOMES FULL WHILE SCANNING AN ORIGINAL

If the memory becomes full while scanning an original, "MEMORY FULL ERROR" will appear in the display and scanning will stop.

If the memory becomes full while the first page is being scanned, scanning will stop and the transmission will be canceled.

If the memory becomes full while scanning a page after the first page, scanning will stop. You can transmit the pages that have already been scanned, or cancel the transmission and clear the pages from memory.

Follow the steps below to transmit or clear the pages that have already been scanned.

1. The memory becomes full and scanning stops. "MEMORY FULL ERROR" appears in the display.
2. To clear the pages that have already been scanned and cancel transmission, press the [◀] key (◀) or [▶] key (▶) to select "2:CANCEL". To transmit the pages that have already been scanned, select "1:SEND XX?".
3. Press the [ENTER] key

The pages are cleared from memory. If you selected "1:SEND XX?" in step 2, the pages are automatically transmitted.



If you are using Quick On-line transmission (p.26), the pages that were scanned are automatically transmitted.

CANCELING (DELETING) A STORED FAX JOB

This procedure is used to check and cancel a fax job that is waiting for transmission, such as an automatic recalling job, a stored fax job, a remote transmission job, or a timer transmission job.



A stored fax job cannot be canceled while transmission of another job is in progress. Wait until transmission is finished and then cancel the stored job.

Follow the steps below to cancel (delete) a fax job:

- 1 Press the [MENU] key.**

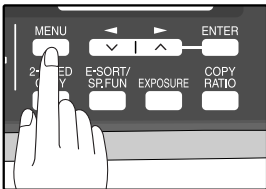

- 2 Press the [◀] key (◀) or [▶] key (▶) until "3:MEMORY STATUS" appears, and then press the [ENTER] key.**

Selection

"3:MEMORY STATUS"

- 3 Press the [◀] key (◀) or [▶] key (▶) until the job that you wish to cancel appears in the display and press the [CLEAR] key (C).**

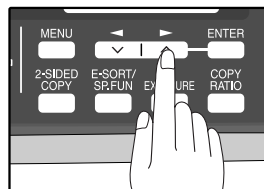

The job to be canceled is selected.

- 4 Press the [ENTER] key.**

The selected job is deleted.

- 5 Press the [MENU] key.**

Press the [MENU] key to exit.

RECEIVING FAXES

You can set the machine to one of three modes of reception, **AUTO**, **MAN.** , or **A.M.** (Answering Machine). To select the reception mode, press the [RECEPTION MODE] key until the desired reception mode appears in the display.

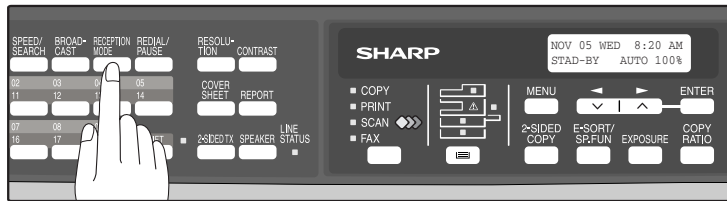

USING AUTO MODE

Select **AUTO** mode when you only want to receive faxes on your telephone line. The machine will automatically answer all calls and receive incoming faxes.

USING MAN. MODE

MAN. is the most convenient mode for receiving phone calls if you have an extension phone. To have true manual mode, the machine must be set to not answer while in MANUAL mode (See "SETTING THE NUMBER OF RINGS FOR MANUAL RECEPTION" (p.29)). You can also receive faxes; however, all calls must first be answered by picking up the receiver on the extension phone or telephone connected to the same line.

USING A.M. MODE

Select this mode when an answering machine is connected to the machine and you want the answering machine to answer all calls. This allows you to receive both voice messages and faxes when you are out.

OPTIONAL RECEPTION SETTINGS

The machine has various optional settings for the reception of faxes.

TWO-SIDED RECEPTION (AR-208D only)

This function is used to print a received fax consisting of two or more pages of the same size on both sides of the paper. Even if the pages are in different orientations, the pages are rotated appropriately to enable printing on both sides of the paper.



The two-sided reception function cannot be used when printing a transaction report or activity report.

To use this feature, follow this procedure:

1 Press the [MENU] key.

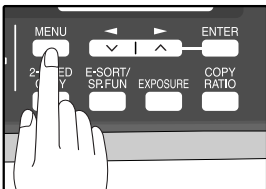

2 Press the [◀] key (▼) or [▶] key (▲) until "4:USER PROGRAM" appears, and then press the [ENTER] key.

Selection

"4:USER PROGRAM"

3 Press the [◀] key (▼) or [▶] key (▲) until "24:2-SIDED RX" appears, and then press the [ENTER] key.

Selection

"24:2-SIDED RX"

4 Press the [◀] key (▼) or [▶] key (▲) to select "1:ON" or "2:OFF".

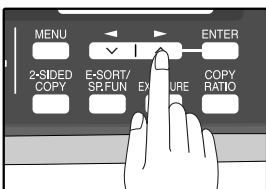

Select "1:ON" to enable the function.
Select "2:OFF" to disable the function.

5 Press the [ENTER] key.

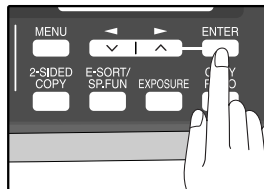

6 Press the [MENU] key.

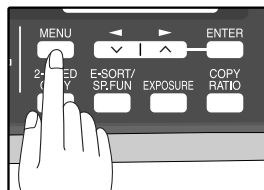

Press the [MENU] key to exit.

RECEIVE REDUCE

You may on occasion receive faxes that are larger than the paper loaded in the machine. To ensure that you do not lose any part of the original, you should use the Receive Reduce function, which scales the fax to the printing paper size.



In some cases the size or resolution of a received fax may not permit reduction. When this happens the fax will be printed at full size and divided onto multiple sheets of paper.

To use this feature, follow this procedure:

1 Press the [MENU] key.

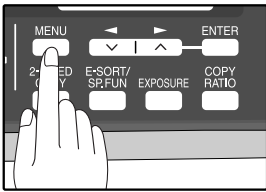

2 Press the [◀] key (⏪) or [▶] key (⏩) until "4:USER PROGRAM" appears, and then press the [ENTER] key.

Selection

"4:USER PROGRAM"

3 Press the [◀] key (⏪) or [▶] key (⏩) until "16:RCV REDUCE" appears, and then press the [ENTER] key.

Selection

"16:RCV REDUCE"

4 Press the [◀] key (⏪) or [▶] key (⏩) to select "1:ON" or "2:OFF".

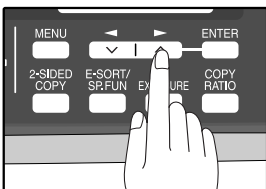

If you "2:OFF" (No reduction) large faxes will be printed on two sheets of paper.

5 Press the [ENTER] key.

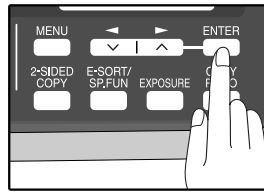

6 Press the [MENU] key.

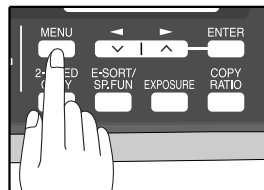

Press the [MENU] key to exit.

4

WHEN USING MANUAL SENDING AND RECEIVING

You need to use the [SPEAKER] key or an extension telephone to perform manual sending and receiving. For information about connecting an extension telephone See "CONNECTING OTHER DEVICES" (p.12).

1 When the extension telephone rings, pick up the handset and converse.

If the [SPEAKER] key is used to answer a call you cannot converse.



You cannot use the [SPEAKER] key for fax transmission/reception while copying is in progress.

2 When the handset is off hook or the [SPEAKER] key is used, press the [START] key (⊙).

MANUAL MODE
1:SEND, 2:RECEIVE

Press the [◀] key (◀) or [▶] key (▶) to select "1:SEND" or "2:RECEIVE", and then press the [ENTER] key or [START] key (⊙).

MEMORY

Your machine has a memory area that can be used to store both incoming faxes and outgoing originals.

- Approximately 120 pages of average content can be held in memory for transmission and reception. Less can be held if any of the pages were scanned using fine or superfine resolution.

Substitute Reception into Memory

This is a back-up function that is automatically activated if your fax runs out of paper, the TD cartridge needs replacement (See the Operation Manual for general information.), or the paper jams.

- If you received originals in memory because the fax ran out of paper, be sure to add paper which is the same size as the paper previously used. If not, the original print-out size may not match the size of the printing paper.



Take care that the remaining memory does not become 7% or less, or you cannot receive any more faxes. When the machine is idle, the LCD shows the stand-by memory available. (See "ABOUT THE LIQUID CRYSTAL DISPLAY" (p.16))

DATA TRANSFER

If there is a problem with the machine, you can use the Data Transfer function to have received faxes read into memory and then sent to a different fax machine for printing. This function is used when you cannot print received faxes, for example when the machine runs out of toner, or a misfeed occurs.

To use this function, the fax number of the transfer destination machine must be programmed.

Your fax machine

Enter the fax number of the fax machine you want to transfer the data to.

[Preparation]



FW. RX DATA
1=YES 2=NO
Select data transfer mode



Receiving fax machine

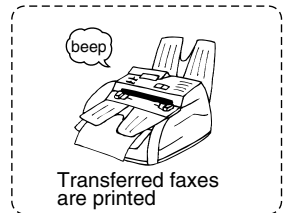

Note Transfer is only possible when a received fax is being held in memory because printing was not possible. In this case, "0:RX DATA TRANSFER" will appear in the display.

Follow these steps to program the fax number of the transfer destination machine:

1 Press the [MENU] key.

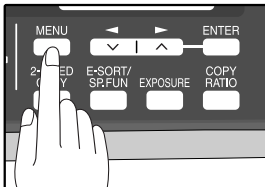

2 Press the [◀] key (▼) or [▶] key (▲) until "0:RX DATA TRANSFER" appears, and then press the [ENTER] key.

Selection

"0:RX DATA TRANSFER"

3 Press the [◀] key (▼) or [▶] key (▲) until "2:FAX NUMBER" appears, and then press the [ENTER] key.

Selection

"2:FAX NUMBER"

4 Enter the fax number of the transfer destination machine with the numeric keys and press the [ENTER] key.

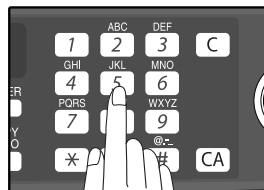

Enter the transferring fax number (maximum 40 digits) by pressing the numeric keys.

5 Enter the name of the transfer destination with the numeric keys and press the [ENTER] key.

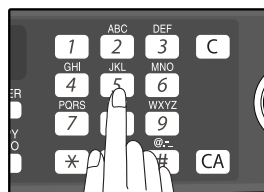

Follow these steps to use the fax transfer function:

1 Press the [MENU] key.

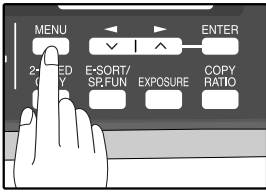

2 Press the [◀] key (⏪) or [▶] key (⏩) until "0:RX DATA TRANSFER" appears, and then press the [ENTER] key.

Selection

"0:RX DATA TRANSFER"

3 Press the [◀] key (⏪) or [▶] key (⏩) until "1:DATA TRANSFER" appears, and then press the [ENTER] key.

Selection

"1:DATA TRANSFER"

4 Press the [◀] key (⏪) or [▶] key (⏩) until "1:YES" appears, and then press the [ENTER] key.

Selection

"1:YES"

The received fax is transferred.

To cancel the transfer, select "2:NO" and press the [ENTER] key.

If "NOT STORED FW.#" appears:

The transfer destination number has not been programmed. Program the number and then transfer the fax.



If you set the data transfer mode, when data cannot be transferred because the other fax machine was busy, or when the error condition on your fax machine is corrected, the data does not print out. To print the data, turn off the power to the fax machine, then turn it on again.

TRANSMISSION RESERVATION

When your fax is busy receiving an original or transmitting an original from memory, you can "reserve" a transmission by setting the original (either in the RSPF or on the document glass), reading it into memory, and entering the fax number. Once the current operation is completed, your fax will automatically dial the number and transmit the original saving you from having to wait.

When Using the RSPF:

1 Confirm that there are no originals on the document glass and that copying is not in progress, then gently close the RSPF.

2 Adjust the original guides to the width of your original.

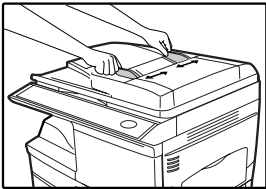

3 Place the original face up and push it gently into the RSPF. The top edge of the original should enter the fax first.

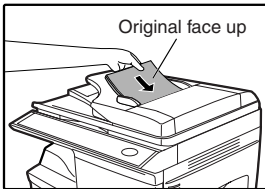

Adjust the resolution and/or contrast settings if desired.

4 Enter the number of the receiving machine using one of the following methods:

- Press a Rapid key.
If you press a Rapid Key, the next step is not necessary.
The number will be dialed once the current operation is completed, and transmission will begin once the connection is made.
- Press the [SPEED/SEARCH] key and enter a Speed Dial number.
- Enter a full number with the numeric keys.

5 Press the [START] key (⊙) if you entered a Speed Dial number or a full number.

- The number will be dialed once the current operation is completed, and transmission will begin once the connection is made.

When placing the Original on the Table:

1 Confirm that there are no original(s) in the RSPF, and open the RSPF.

2 Place the original face down on the document glass. Align the original according to the original scale in the illustration below. (Line up the center of the edge of the original with the (▶) mark.)

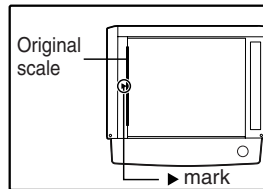

3 Gently close the RSPF.

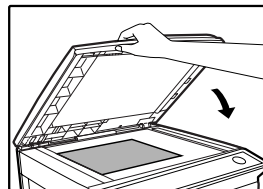

When using the document glass, do not set original(s) in the RSPF.

4 If needed, set the original size, resolution, and contrast. (See "DIALING AND TRANSMITTING" (p.59))

5 Press the [START] key (⊙) to scan the page into memory. If you have more than one original to read into memory, place the next page, and press the [START] key (⊙) to read each page.

6 Press the [#] key.

BROADCASTING

This function allows you to send the same original to as many as 100 different locations with just one operation. Once the original is loaded, it is scanned and stored in memory. The fax numbers you have entered are then automatically dialed in succession, and the original is transmitted to each location.

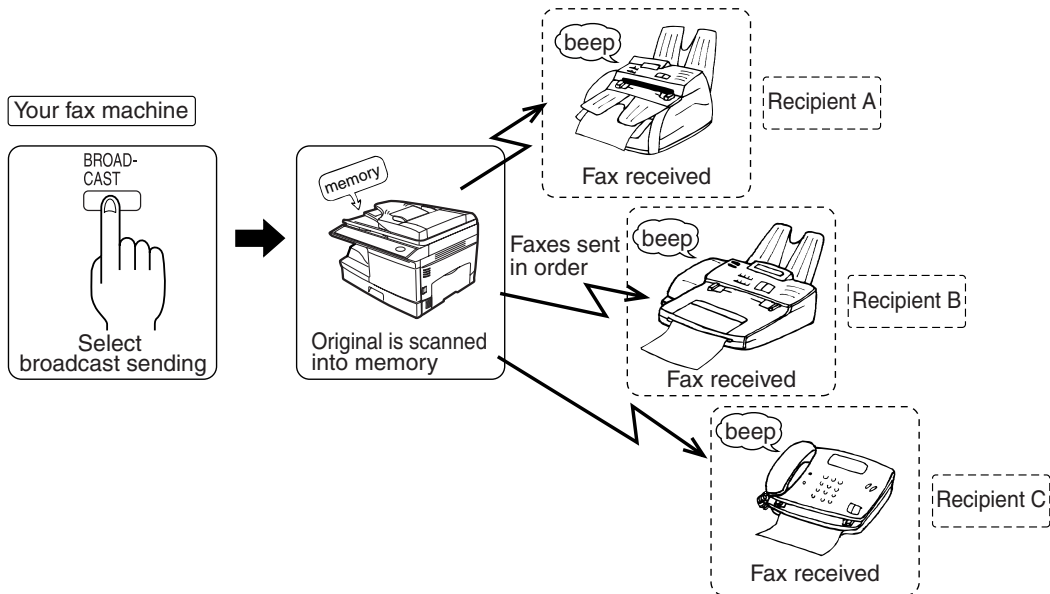

1 Place the original face up and push it gently into the original feeder tray.

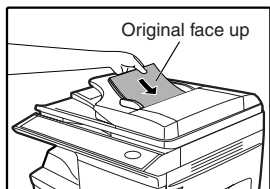

2 Press the [BROADCAST] key.

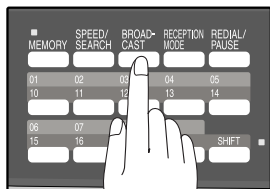

Adjust the resolution and/or contrast settings if desired.



Adjust the resolution and contrast settings after the [BROADCAST] key has been pressed.

3 Dial the numbers of the receiving machines using one or more of the following methods:

- Press one or more Rapid keys.
- Enter Speed Dial numbers with the numeric keys.
- Press one or more Group keys.
- Enter a number with the numeric keys.

4 Press the [ENTER] key.

To enter another fax number, return to step 3.

5 Press the [START] key (⊙).

Transmission will begin.



5

Broadcasting using a Group key

If the fax machines to which you want to broadcast have all been programmed into one Group key, you can perform the broadcasting operation using the following simplified procedure. Refer to "STORING NUMBERS UNDER GROUP KEYS" (p.45).

1 Place the original face up and push it gently into the document feeder tray.

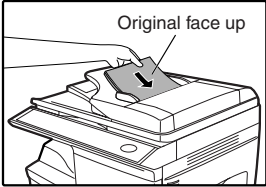

Adjust the resolution and/or contrast settings if desired.

2 Press the appropriate Group key.

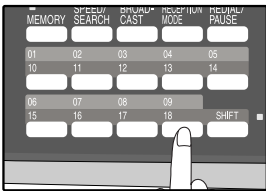

Transmission will begin.

POLLING

Polling allows you to request another fax machine to send an original to your fax machine. In other words, the receiving fax machine, not the transmitting fax machine, activates the transmission. You can use your fax to both poll and be polled by others.

Serial polling can be used to poll multiple fax machines (maximum of 100) in a single operation.

POLLING

You can request that another fax machine send you the original that is set in that fax machine. You can perform a polling operation at a scheduled time. (See "TIMER OPERATIONS" (p.79))

Polling fax

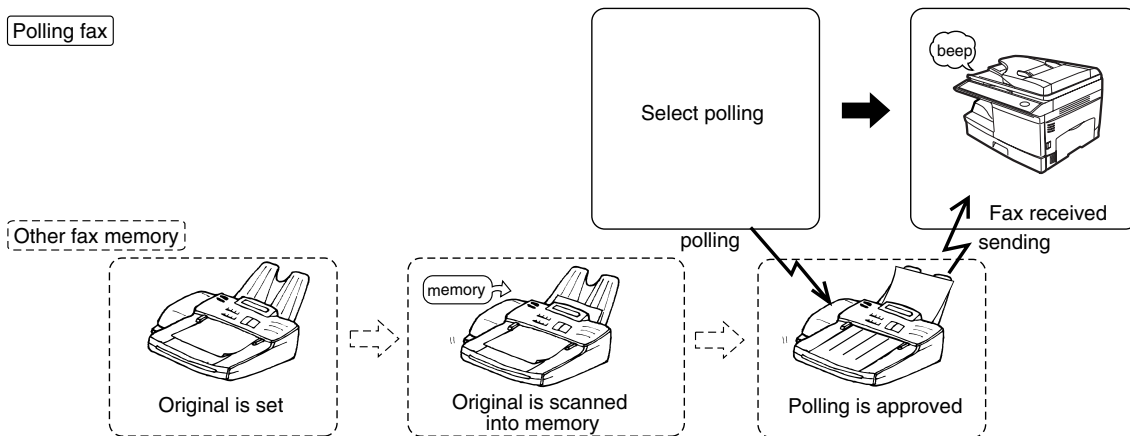

Follow these steps to use the polling function:

1 Press the [MENU] key.

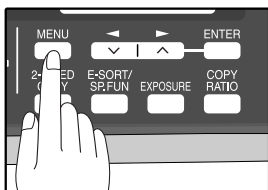

2 Press the [◀] key (◀) or [▶] key (▶) until "8:POLLING MODE" appears, and then press the [ENTER] key.

Selection

"8:POLLING MODE"

3 Dial the number of the fax machine you want to poll using one of the following methods:

- Press a Rapid Key.
If you press a Rapid Key, the next step is not necessary.
- Press the [SPEED/SEARCH] key and enter a two-digit Speed Dial number.
- Enter the fax number with the numeric keys.



A group key can be pressed to perform serial polling. Fax reception will take place in the order that the destinations are stored in the Group Key.

4 Press the [START] key (⊙).



SERIAL POLLING

You can poll several fax machines one at a time with a single serial polling operation. A maximum of 100 fax machines can be polled in one serial polling operation.

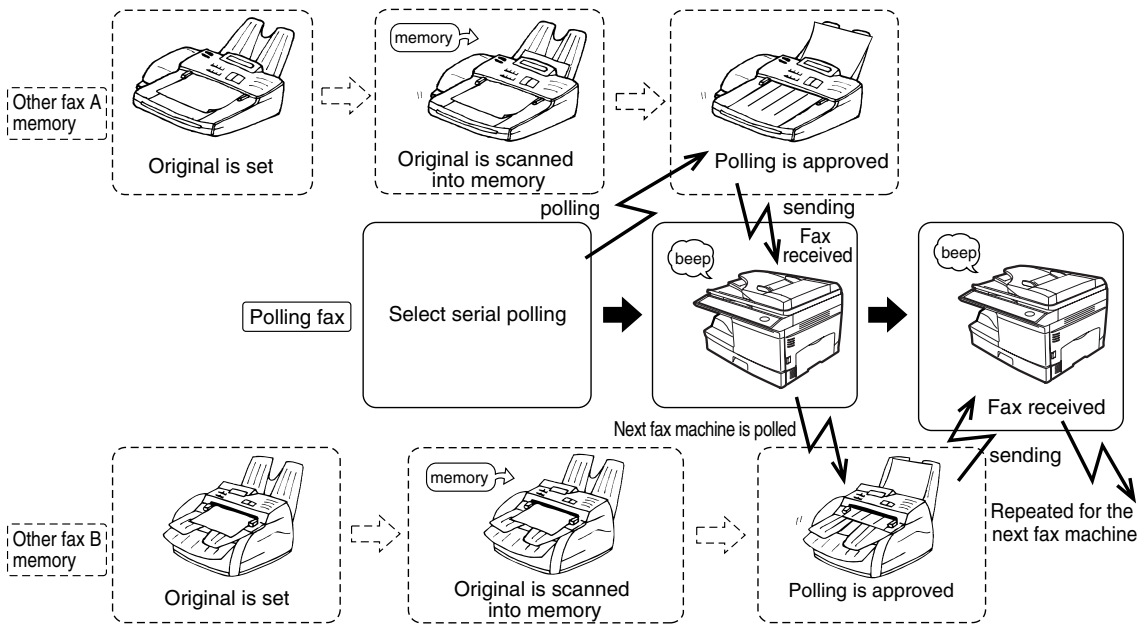

Follow these steps to use the serial polling function:

1 Press the [MENU] key.

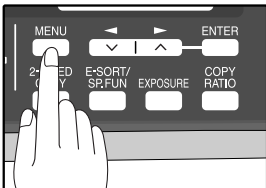

2 Press the [◀] key () or [▶] key () until "9:SERIAL POLL MODE" appears, and then press the [ENTER] key.

Selection

"9:SERIAL POLL MODE"

3 Dial the number of the fax machine you want to poll using one of the following methods:

- Press a Rapid Key or a Group Key.
- Press the [SPEED/SEARCH] key and enter a two-digit Speed Dial number.
- Enter a fax number with the numeric keys.

4 Press the [ENTER] key.

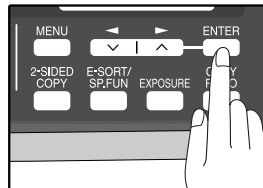

Repeat steps 3 and 4 until all numbers have been entered. After entering the last number, go to step 5.

5 Press the [START] key ().



POLLING TRANSMISSION (MEMORY POLLING)

This function is used to transmit an original that has been scanned into memory to a fax machine that polls your fax machine. If desired, polling fax machines can be restricted to machines whose fax numbers have been programmed in your machine ("RESTRICTING POLLING MACHINES (POLLING SECURITY)" on page 77).

To let other fax machines poll your fax machine, the original to be transmitted must be scanned into memory and the reception mode of your machine must be set to "Auto".

You can select whether polling transmission will take place once or repeatedly. If once is selected, the original that was scanned into memory will be automatically deleted after polling transmission takes place. If repeated polling transmission is selected, the original will remain in memory until it is deleted.

More than one original can be scanned into polling memory (all originals will be transmitted when your machine is polled).

Only one memory polling operation can be set up, and the polling machine must be capable of polling reception.

The original(s) in polling memory will be transmitted when a fax machine calls your fax machine and requests polling transmission. Automatic fax reception is possible while your machine is on polling transmission standby.

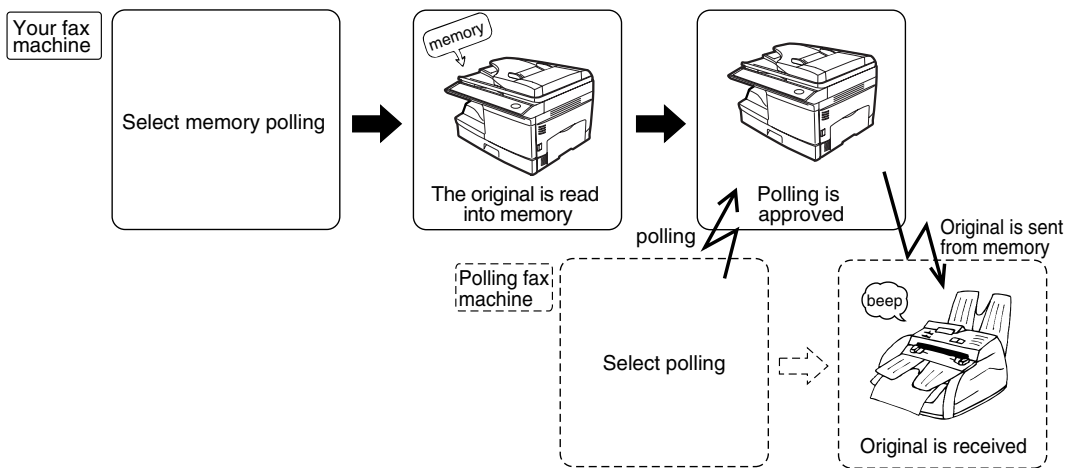

5

Setting up polling transmission:

Place the original in the RSPF or on the document glass and perform the following steps:

1 Press the [MENU] key.

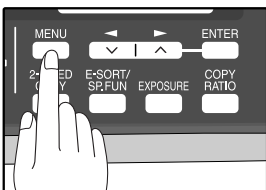

2 Press the [◀] key (◀) or [▶] key (▶) until "7:MEMORY POLL MODE" appears, and then press the [ENTER] key.

Selection

"7:MEMORY POLL MODE"

3 Press the [◀] key (◀) or [▶] key (▶) to select the number of times polling transmission will take place and press the [ENTER] key.

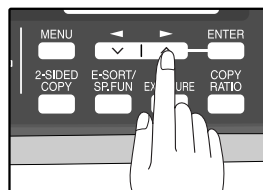

"1:1 TIME" or "2:REPEAT" can be selected as the number of polling operations allowed.

4 Press the [START] key (⊙).



Adding a original to polling memory:

Use this procedure to add an original to another original that has already been scanned into polling memory. Place the original in the RSPF or on the document glass and follow the steps below.

1 Press the [MENU] key.

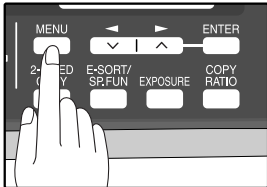

2 Press the [◀] key (◀) or [▶] key (▶) until "7:MEMORY POLL MODE" appears, and then press the [ENTER] key.

Selection

"7:MEMORY POLL MODE"

3 Press the [◀] key (◀) or [▶] key (▶) until "1:SET" appears, and then press the [ENTER] key.

Selection

"1:SET"

4 Press the [◀] key (◀) or [▶] key (▶) to select the number of times polling transmission will take place and press the [ENTER] key.

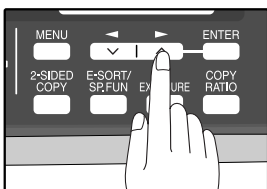

"1:1 TIME" or "2:REPEAT" can be selected as the number of polling operations allowed.

5 Press the [START] key (⊙).

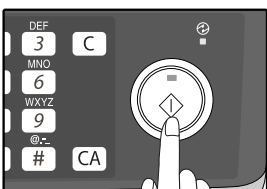

Deleting originals from polling memory:

Follow the steps below to delete originals that have been scanned into polling memory.

1 Press the [MENU] key.

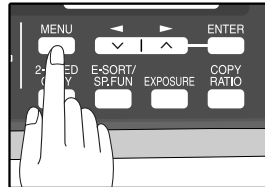

2 Press the [◀] key (◀) or [▶] key (▶) until "7:MEMORY POLL MODE" appears, and then press the [ENTER] key.

Selection

"7:MEMORY POLL MODE"

3 Press the [◀] key (◀) or [▶] key (▶) until "2:CLEAR" appears, and then press the [ENTER] key.

Selection

"2:CLEAR"

4 Press the [START] key ..



RESTRICTING POLLING MACHINES (POLLING SECURITY)

If you wish to allow only specified fax machines to poll your fax machine, enable polling security and program the fax numbers of the machines that are to be allowed to poll your machine. When this is done, polling will take place when the fax number of the polling machine matches one of the fax numbers that have been programmed in your machine. Up to 10 passcode numbers (fax numbers of machines that are allowed to poll your machine) can be programmed. To enable polling security and program passcode numbers, see "Programming/deleting passcode numbers:" on page 78.

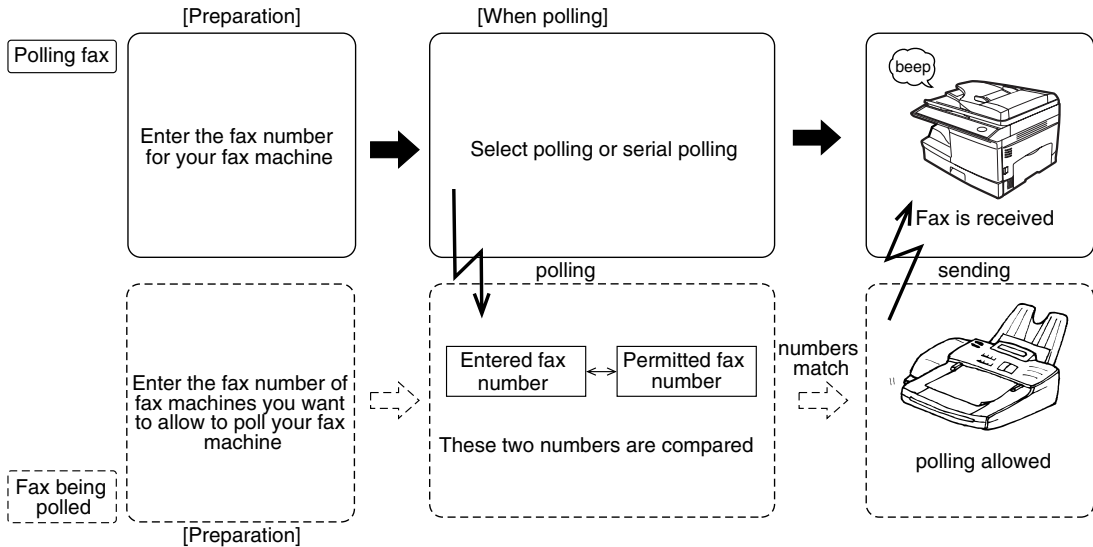

Follow these steps to enable polling security:

1 Press the [MENU] key.

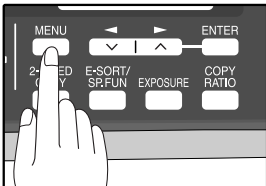

2 Press the [◀] key (◀) or [▶] key (▶) until "4:USER PROGRAM" appears, and then press the [ENTER] key.

Selection

"4:USER PROGRAM"

3 Press the [◀] key (◀) or [▶] key (▶) until "12:SECURITY SELECT" appears, and then press the [ENTER] key.

Selection

"12:SECURITY SELECT"

4 Press the [◀] key (◀) or [▶] key (▶) to select "1:ON".

Selection

"1:ON"

To turn off polling security, select "2:OFF".

5 Press the [ENTER] key.

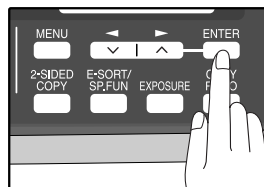

6 Press the [MENU] key.

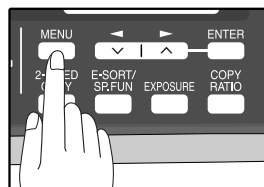

Press the [MENU] key to exit.

Programming/deleting passcode numbers:

1 Press the [MENU] key.

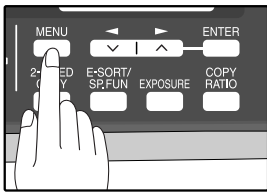

2 Press the [◀] key (▽) or [▶] key (△) until "2:ENTRY MODE" appears, and then press the [ENTER] key.

Selection

"2:ENTRY MODE"

3 Press the [◀] key (▽) or [▶] key (△) until "4:PASSCODE # MODE" appears, and then press the [ENTER] key.

Selection

"4:PASSCODE # MODE"

4 Press the [◀] key (▽) or [▶] key (△) to select "1:SET" and press the [ENTER] key.

Selection

"1:SET"

To delete a passcode number:

Select "2:CLEAR" and press the [ENTER] key.

5 Enter a two-digit number that will be used to identify the passcode number and then press the [ENTER] key.



To delete a passcode number:

Enter the two-digit number that identifies the passcode number and press the [ENTER] key. The passcode is deleted.

6 Enter the passcode (fax number of the machine to be allowed to poll your machine) with the numeric keys and press the [ENTER] key.

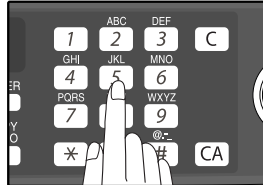

7 Press the [MENU] key.

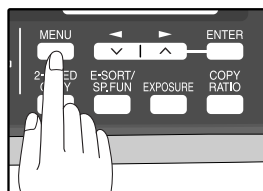

Press the [MENU] key to exit.

TIMER OPERATIONS

The timer function allows you to set a transmission or polling operation to be performed automatically at a time you specify. Up to five transmission operations or polling operations can be set at any one time, and the times they will be performed can be specified up to a week in advance.

You can use this function, for example, to take advantage of lower night time telephone rates without having to be there when the operation is performed.

- For a timer transmission, scan the original into memory when you set the transmission. Scanning the original into memory is convenient because you do not have to worry about original mix-ups or forgetting to load the original.
- If the memory becomes full while the original is being scanned, "MEMORY FULL" will appear in the display.
 - Press the [START] key (⊙) to transmit the pages that have been stored up to that point in memory.
 - Press the [CLEAR ALL] key (CA) to cancel the entire transmission.

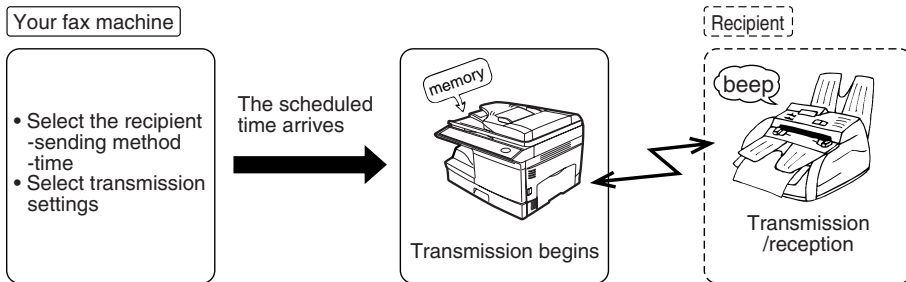

Setting up a timer transmission job:

1 Press the [MENU] key.

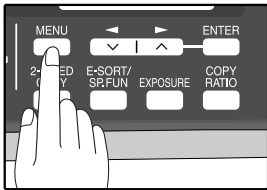

2 Press the [◀] key (left arrow) or [▶] key (right arrow) until "1:TIMER MODE" appears, and then press the [ENTER] key.

Selection

"1:TIMER MODE"

3 Press the [◀] key (left arrow) or [▶] key (right arrow) to select "1:SET".

Selection

"1:SET"

4 Enter the time at which transmission will take place with the numeric keys.

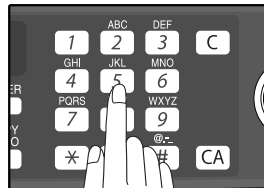

Enter two digits for the hour and two digits for the minute.

5 Press the [◀] key (left arrow) or [▶] key (right arrow) to select "AM" or "PM" and press the [ENTER] key.

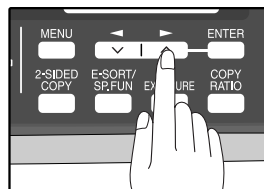

5

To cancel a timer operation, select "2:CLEAR".

6 Press the [◀] key (◀) or [▶] key (▶) to select the day of the week and press the [ENTER] key.

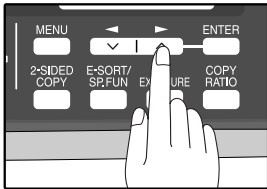

7 Press the [ENTER] key.

8 Press the [◀] key (◀) or [▶] key (▶) to select the transmission mode and press the [ENTER] key.

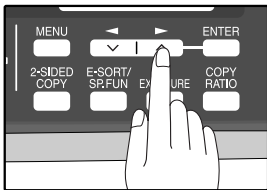

The selections are as follows:
 1:SEND MODE
 2:BROADCAST MODE
 3:POLLING MODE
 4:SERIAL POLL MODE

9 Enter the fax number of the other machine using one of the following methods:

- Press a Rapid key.
If you press a Rapid Key, the next step is not necessary.
- Enter a Speed Dial number with the numeric keys.
- Enter the fax number with the numeric keys.

10 Press the [START] key (⊙).

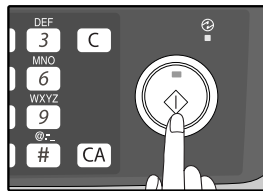

CANCELING A TIMER TRANSMISSION JOB

After a timer transmission job is set up, the job goes on standby until the specified time of transmission. If necessary, the MEMORY STATUS function can be used to cancel a timer transmission job that is on standby ("CANCELING (DELETING) A STORED FAX JOB" on page 62).

ANTI JUNK FAX

You can avoid wasting fax paper by using the Anti Junk Fax function. This function blocks reception of faxes from up to ten specified parties.

To turn the Anti Junk Fax feature on and off, use the following procedure:

1 Press the [MENU] key.

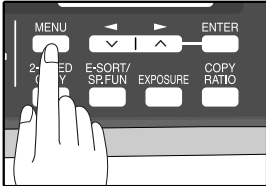

2 Press the [◀] key (▼) or [▶] key (▢) until "5:ANTI JUNK FAX" appears, and then press the [ENTER] key.

Selection

"5:ANTI JUNK FAX"

3 Press the [◀] key (▼) or [▶] key (▢) to select "1:ANTI JUNK SELECT" and press the [ENTER] key.

Selection

"1:ANTI JUNK SELECT"

4 Press the [◀] key (▼) or [▶] key (▢) to select "1:ON" or "2:OFF" and press the [ENTER] key.

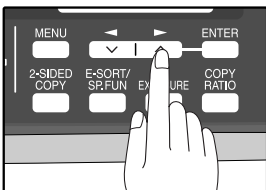

Select "1:ON" to enable the function.
Select "2:OFF" to disable the function.

5 Press the [MENU] key.

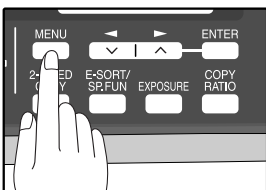

Press the [MENU] key to exit.

To store junk fax numbers, use the following procedure:

1 Press the [MENU] key.

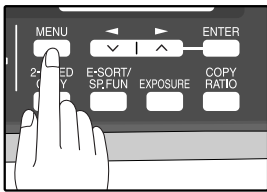

2 Press the [◀] key (◁) or [▶] key (▷) until "5:ANTI JUNK FAX" appears, and then press the [ENTER] key.

Selection

"5:ANTI JUNK FAX"

3 Press the [◀] key (◁) or [▶] key (▷) to select "2:JUNK FAX #" and press the [ENTER] key.

Selection

"2:JUNK FAX #"

4 Press the [◀] key (◁) or [▶] key (▷) to select "1:SET" and press the [ENTER] key.

Selection

"1:SET"

5 Enter a two-digit number from 01 to 10 that will identify the anti junk number and press the [ENTER] key.

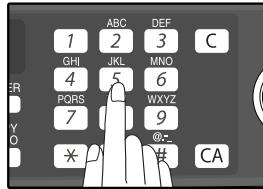

If you enter a two-digit number that already has a fax number stored, "#xx STORED:CHANGE?" will appear. To change the fax number that has been stored under that 2-digit number, press the [◀] key (◁) or [▶] key (▷) to select "YES", press the [ENTER] key, and enter the new fax number.

6 Enter the fax number with the numeric keys and press the [ENTER] key.

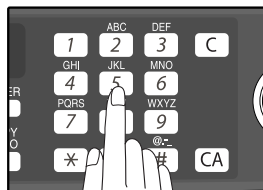

7 Press the [MENU] key.

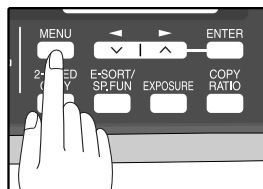

If you wish to store another fax number, return to step 5. Press the [MENU] key to exit.

To clear junk fax numbers, use the following procedure:

1 Press the [MENU] key.

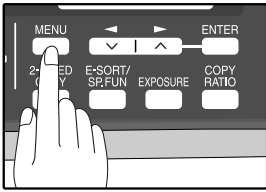

2 Press the [◀] key (▼) or [▶] key (▲) until "5:ANTI JUNK FAX" appears, and then press the [ENTER] key.

Selection

"5:ANTI JUNK FAX"

3 Press the [◀] key (▼) or [▶] key (▲) to select "2:JUNK FAX #" and press the [ENTER] key.

Selection

"2:JUNK FAX #"

4 Press the [◀] key (▼) or [▶] key (▲) to select "2:CLEAR" and press the [ENTER] key.

Selection

"2:CLEAR"

5 Press the numeric keys to enter the two-digit number (01 to 10) that identifies the fax number you wish to delete.



6 Press the [ENTER] key.

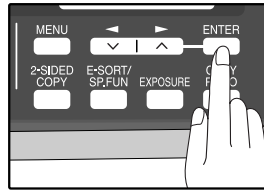

If you wish to store another fax number, return to step 5.

7 Press the [MENU] key.

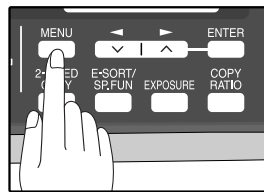

Press the [MENU] key to exit.

OPERATION IN COPY, PRINTER, SCANNER, AND FAX MODES

Some operations cannot be performed simultaneously when the machine is being used in printer mode, copy mode, scanner mode, and fax mode.

Modes		Copy	Printer	Scanner		Fax		Extension phone
		Copying	Printing	Scanning from a machine	Scanning from a computer	Transmission	Reception	
Copy	Key entry	Yes	Yes	No	Yes	Yes*1	Yes	Yes
	During copying		No	No	No	Yes*1	Yes*2	Yes
Printer	Printing	Yes		Yes	Yes	Yes	Yes*2	Yes
Scanner	During scanning	No	Yes			Yes*1	Yes	Yes
Fax transmission	Key entry	No	Yes	No	Yes	Yes	Yes	Yes
	During direct transmission	No	Yes	No	No		No	No
	During scanning	No	Yes	No	No	Yes*1	Yes*4	Yes
	During memory transmission	Yes	Yes	Yes	Yes	No*3	No	No
Fax reception	During manual reception	Yes	No	Yes	Yes	No*3		No
	During printing of a received fax	Yes	No	Yes	Yes	Yes	Yes*2	Yes
	During memory reception	Yes	Yes	Yes	Yes	No*3		No
Extension phone		Yes	Yes	Yes	Yes	No*3	No	

*1 Direct transmission and scanning are not possible.

*2 Manual reception and printing of a received fax are not possible.

*3 Only scanning is possible.

*4 Manual reception is not possible.

PRINTING OUT REPORTS

The machine is capable of printing a range of reports on faxing activities as well as various settings you have made. The reports are described below.

1. TIMER LIST:

You can print a list of timer or dual access operations that are currently set.

P.01

TIMER LIST

SEP-10-200X FRI 06:30 PM

TIMER MODE

FILE	RESERVED	TYPE	RES.	MSG	BOX	PAGES	CVR.	RECEIVER
01	XXXX XX XXX	XXXXXXXXXX	XXX	X	XX	X	XXX	XXX XXX XXX
02	XXXX XX XXX	XXXXXXXXXX	XXX			X	XXX	XXX XXX XXX
03	XXXX XX XXX	XXXXXXXXXX	XXX				XXX	XXX XXX XXX
04	XXXX XX XXX	XXXXXXXXXX	XXX				XXX	XXX XXX XXX
05	XXXX XX XXX	XXXXXXXXXX	XXX				XXX	XXX XXX XXX
06	XXXX XX XXX	XXXXXXXXXX	XXX				XXX	XXX XXX XXX
07	XXXX XX XXX	XXXXXXXXXX	XXX	X	XX		XXX	XXX XXX XXX

MEMORY TX

FILE	TYPE	RES.	MSG	BOX	PAGES	CVR.	RECEIVER
XXXX		XXX	X	XX	X	XXX	
XXXX		XXX	X	XX	X	XXX	

REMOTE TX

#	TYPE	RES.	MSG	PAGES	CVR.	TIMES
1		XXX	X	X		XXXX

2. ACTIVITY REPORT:

You can print out a list of faxes sent and received as well as the sender or recipient and the time of the operation, etc.

P.01

ACTIVITY REPORT (SEND)

SEP-10-200X FRI 06:30 PM

#	DATE	START TIME	RECEIVER	COM.TIME	PAGES	TYPE/NOTE	FILE
XX	SEP-10	XX:XX PM	XX	XXXX	XX	XXXXXXXX	XXX
TOTAL				XXXX	XX		
GRAND TOTAL				XXXX	XX		

3. TELEPHONE # LIST:

You can print out a list of number stored in rapid dialing and speed dialing.

P.01

TELEPHONE NUMBER LIST

SEP-10-200X FRI 06:30 PM

RAPID/SPEED #	RECEIVER'S FAX #	INTL TX SET	RECEIVER'S NAME
XXX	XXXXXXXXXXXXXX	XXXX	XXXXXXXXXXXXXX
XXX	XXXXXXXXXXXXXX	XXXX	XXXXXXXXXXXXXX
XXX	XXXXXXXXXXXXXX	XXXX	XXXXXXXXXXXXXX

4. GROUP LIST:

You can print out a list of group dialing numbers.

P.01

GROUP LIST

SEP-10-200X FRI 06:30 PM

#	GROUP NAME	RECEIVER
GRX	XXXX	RAPID# XX SPEED# XXX FAX# XXXXXXXXXXXXXXXXXXXX
GRX	XXXX	GROUP# XXX-XXX
GRX	XXXX	FAX# XXXXXXX XXXXXXX XXXXXXX

5. PASSCODE LIST:

You can print a list of your fax information and polling security information.

PASSCODE LIST		SEP-10-200X FRI 06:30 PM
POLL SECURITY		
STATION #	XXXX	
01 #	01	XXXX
	02	XXXX
	03	
	04	
	05	
	06	
	07	
	08	
	09	
	10	
PASSCODE #		XXXXXXXXXX XXXXXXXXXX
	01	XXXXXXXXXX
	02	XXXXXXXXXX
	03	
	04	
	05	
	06	
	07	
	08	
	09	
	10	
SENDER'S NAME	XXXXXXXXXXXXXXXXXXXX	
SENDER'S #	XXXXXXXXXXXXXXXXXXXX	
TO TEL. NAME	XXXXXXXXXXXXXXXXXXXX	
TO STATION #	XXXXXXXXXXXXXXXXXXXX	

6. JUNK FAX # LIST:

Fax numbers designated as Anti Junk Fax numbers.

JUNK FAX# LIST		SEP-10-200X FRI 06:30 PM
#		ANTI JUNK FAX #
01	5	
02	XXXXXXXXXX	
10	XXXXXXXXXXXXXXXXXXXX	

7. USER PROGRAM LIST:

Currently activated USER PROGRAM settings.

USER PROGRAM LIST			
SEP-10-200X FRI 06:30 PM			
MENU #	ITEM	SETTING	
1	DOC. CLASS SIZE	A5/L11	
2	THICK DOC. SIZE	A5/L11	
3	REGD. PRIORITY	STANDARD	
4	PDF FINDER ACTIVATION	OFF/ENABLE	
5	PDF FINDER MANUAL EX.	OFF/ENABLE	
6	AUTO LENSING	OFF	
7	PRINT SELECTION	SEND ERROR ONLY	RD. ALLWAYS PRINTS
		NOV. OTHER PRINTS	IMAGE. ERROR ONLY
8	RECALL TIMES (DUV)	OFF/ENABLE	
9	RECALL TIMES (LINE ERROR)	OFF/ENABLE	
10	RECALL INTERVAL (DUV)	MIN/ON	
11	RECALL INTERVAL (LINE ERROR)	MIN/ON	
12	SECURITY SELECTION	ON	
13	CALL NUMBER NUMBER	3	
14	NUMBER OF COPY	ON	
15	CALL SIGNAL AUTO RECEIVING	ON	
16	AUTO BICY REDUCE	ON	
17	REEP LENGTH	3000	
18	REORDER VOLUME	MIDDLE	
19	DEEPER VOLUME	LOW	
20	CALL MEXER	TONE	
21	REORDER COPY SEND	OFF	
22	NO COPY PRINT	OFF	
23	DATE/TIME FORMAT SET	TIME / 12H/24H	
		DATE / MM/DD/YYYY	
24	1-REORDER	OFF	

Use the following procedure to print out reports:

1 Press the [REPORT] key.

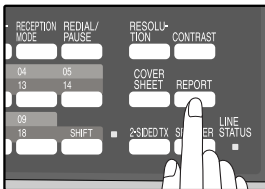

3 Press the [ENTER] key.

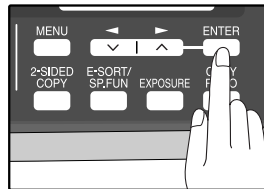

2 Press the [REPORT] key to select the report that you wish to print.

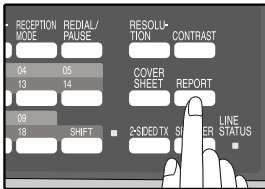

6

ACTIVITY REPORT AUTO LISTING

This setting is used to automatically print the Activity Report for transmissions and receptions. The Activity Report will automatically print when information on a total of 50 fax transmissions and receptions accumulates. Once information on 50 transmissions/receptions accumulates, the oldest transaction is deleted each time a new transaction takes place.

1 Press the [MENU] key.

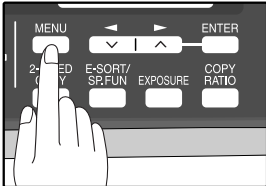

2 Press the [◀] key (◻) or [▶] key (◻) until "4:USER PROGRAM" appears, and then press the [ENTER] key.

Selection

"4:USER PROGRAM"

3 Press the [◀] key (◻) or [▶] key (◻) until "6:AUTO LISTING" appears, and then press the [ENTER] key.

Selection

"6:AUTO LISTING"

4 Press the [◀] key (◻) or [▶] key (◻) to select "1:ON" and press the [ENTER] key.

Selection

"1:ON"

To disable automatic printing, select "2:OFF" and press the [ENTER] key.

5 Press the [MENU] key.

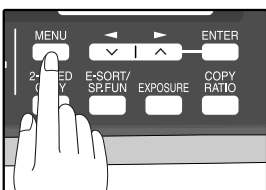

Press the [MENU] key to exit.

PRINTING TRANSACTION REPORTS

The machine can be set to print a transaction report after each transmission, reception, and/or error. The printing condition can be selected separately for three types of transaction reports: "TRANSMISSION LIST", "BROADCAST LIST", and "RECEPTION LIST". For each type of report, select one of the following printing conditions:

"ALWAYS PRINTS"After each transmission, reception, or error.

"ERROR ONLY"After an error only.

"NEVER PRINTS"Never prints.



Part of the transmitted fax can be printed on the transaction report (IMAGE MEM. PRINT setting).

To set the machine to print transaction reports, follow these steps:

1 Press the [MENU] key.

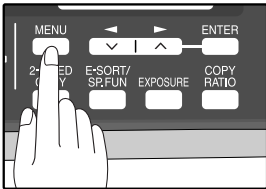

2 Press the [◀] key (◀) or [▶] key (▶) until "4:USER PROGRAM" appears, and then press the [ENTER] key.

Selection

"4:USER PROGRAM"

3 Press the [◀] key (◀) or [▶] key (▶) until "7:PRINT SELECTION" appears, and then press the [ENTER] key.

Selection

"7:PRINT SELECTION"

4 Press the [◀] key (◀) or [▶] key (▶) to select the type of transaction report and press the [ENTER] key.

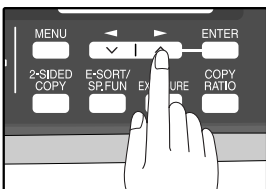

The selections are as follows:

1:TRANSMISSION

2:BROADCAST

3:RECEPTION

4:IMAGE MEM. PRINT

"4: IMAGE MEM. PRINT" can be enabled to have part of the transmitted fax printed on the transaction report.

5 Press the [◀] key (◀) or [▶] key (▶) to select the printing condition and press the [ENTER] key.

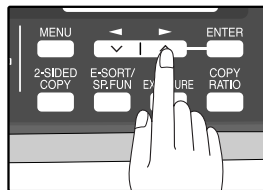

The selections are as follows:

1:ALWAYS PRINTS

2:ERROR ONLY

3:NEVER PRINTS

6 Press the [MENU] key.

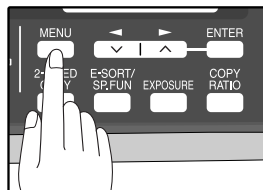

Press the [MENU] key to exit.

TROUBLESHOOTING

Problem	Cause and solution	Page
Dialing cannot be done.	The telephone line cord is not correctly connected to the machine and the wall telephone jack. → Make sure the telephone line cord is securely connected.	11
No transmission takes place.	The receiving machine is out of paper. → Check with the operator of the receiving machine.	-
	The receiving machine does not support the G3 standard. → Check with the operator of the receiving machine.	-
	An error is displayed. → Check the display of the machine.	91
Nothing is printed at the receiving end.	If a blank sheet of paper is output together with a normally received fax, the machine's paper size setting may be different from the size of paper actually loaded in the machine. → Make sure that the paper size setting matches the size of paper loaded in the machine.	29
A distorted image is received at the other end.	Noise on the line may cause a distorted image. Try sending the fax again, or make a copy on your machine and see if the copy is distorted. → If the image is still distorted, consult the retailer or dealer where you bought the machine.	-
The received original is faint.	The transmitting machine may be using a light contrast setting. → Ask the operator of the transmitting machine to send the fax using a darker contrast setting.	-
Received images are distorted.	Noise on the line may cause a distorted image. → Ask the operator of the transmitting machine to send the fax again.	-
	The TD cartridge may be running out of toner. → Replace the TD cartridge.	Operation Manual (for general information)



If your problem cannot be solved by carrying out the instructions in the Check and Remedy column above, please contact your authorized SHARP dealer.

MESSAGES AND SIGNALS

DISPLAY MESSAGES

Message	Cause and remedy	Page
FRONT OR SIDE COVER OPEN. CLOSE COVERS.	The cover is open. Close the cover.	See the OPERATION MANUAL (for general information)
CLOSE THE SPF/RSPF COVER.	The RSPF cover is open. Close the RSPF cover.	
CLEAR PAPER JAM.	A paper misfeed has occurred. Remove the misfeed as explained in "MISFEED REMOVAL". (See the OPERATION MANUAL for general information.)	
SPF/RSPF JAM.		
MEMORY FULL	The memory is full.	62
LOAD XXX SIZE PAPER INTO TRAY1	The setting for the printing paper size is incorrect. Set it correctly. "8.5x11", "8.5x14", or "A4" will appear in "XXX" in the message.	29
CAN NOT PRINT	Toner cartridge is empty. Toner cartridge is not inserted.	See the OPERATION MANUAL (for general information)
NO XXX SIZE TRAY CHANGE TRAY SETTING	Paper tray is not set to the appropriate paper size. Change the paper size setting of the paper tray to the size indicated in the message, and load that size of paper in the paper tray. "8.5x11", "8.5x14", or "A4" will appear in "XXX" in the message.	-

AUDIBLE SIGNALS

Sound Type	Duration	Meaning
Continuous tone	3 seconds	Indicates the end of transmission, reception, or line error.
Continuous tone	1 second	Warning tone

SPECIFICATIONS

Applicable telephone line	Public switched telephone network
Compression method	MH, MR, MMR, JBIG
Transmission modes	Super G3, G3 (the machine can only send faxes to and receive faxes from machines that support G3 or Super G3)
Scanning method	CCD flatbed scanning
Scanning resolution (supports ITU-T standards)	8 x 3.85 lines/mm (Standard) 8 x 7.7 lines/mm (Fine, Fine + Halftone) 8 x 15.4 lines/mm (Super Fine, Super Fine + Halftone)
Recording method	Laser, electrostatic charge method
Transmission speed	33.6 kbps → 2.4 kbps Automatic fallback
Transmission time	Approx. 2 seconds (Super G3 mode / 33.6 kbps, JBIG), Approx. 6 seconds (G3 ECM mode / 14.4 kbps, JBIG)
Paper size	8-1/2" x 11"(Letter), 8-1/2" x 14"(Legal), or A4
Effective recording width	8-1/2" max. (8-1/2" x 14" printing)
Transmittable original size	When using the RSPF Maximum One-sided original: 8-1/2" x 19.7" Two-sided original: 8-1/2" x 14" Minimum 8-1/2" x 5-1/2" When using the document glass Maximum 8-1/2" x 14"
Effective scanning width	8-1/2" maximum
Halftone transmission	256 levels
Contrast (exposure) adjustment	Light, Medium, Dark
Extension telephone connection	Possible (1 telephone)
Auto dialing	Combined total of 18 One-Touch Dial and Group keys; 100 Speed Dial numbers; redialing (automatic)
Timer transmission	Yes
Automatic document feeding	Yes (50 pages)
Memory capacity	2 MB
Error Correction Mode(ECM)	Yes

* As a part of our policy of continuous improvement, SHARP reserves the right to make design and specification changes for product improvement without prior notice. The performance specification figures indicated are nominal values of production machines. There may be some deviations from these values in individual machines.

INDEX

A	
Alarm beeps	
- Alarm beep volume	19
- Length of alarm beeps	18
Answering machine	48
- Answering machine backup	49
- Quiet detect time	48
Arrow keys	15, 16
Automatic dialing	
- Group keys	45
- Rapid key dialing	42
- Speed dialing	42
B	
Beep volume	16
Bypass tray paper guides	13
C	
Clear numbers	
- Group keys	47
- Rapid key dialing	44
- Speed dialing	44
Connecting	
- Other devices	12
- Telephone line cord	11
Contrast	55
Cover sheet	56
D	
Dialing	
- Direct keypad dialing	59
- Rapid key dialing	59
- Redialing	61
- Search	61
- Speed dialing	59
- Using the [SPEAKER] key	60
Display	14, 16
Distinctive ringing	41
Document glass	13
E	
Entering your name and fax number	21
F	
Fax main menu	6
Fax setup	
- Date and time	22
- Daylight saving time setting	25
- Dial mode	31
- Distinctive ringing	41
- How to enter characters	20
- Index function	36
- Number of recall times	32
- Number of rings for auto reception	28
- Number of rings for manual reception	29
- Recall interval	34
- Reception mode	27
- Reception paper size	29
- Remote reception	39
- Resolution priority	37
- Transmission mode	26
- Setting the tray selection	30
- Your name and fax number	21
H	
Handles	13
I	
Index function	36
L	
Line jack	13
List of fax functions	6
M	
Memory	67
Message function	57
Messages and signals	91
O	
Operation panel	13
Optional transmission settings	
- Cover sheet	56
- Message function	57
- Two-sided original	58
Originals	50
- Original size	54
- Setting the original	52
- Size and weight	50
- Two-sided original	58
- Unsuitable originals	51
P	
Paper output tray	13
Paper output tray extension	13
Paper tray	13
PC modem	38
Power cord	13
Power switch	13
Q	
Quick reference guide	3

R

Receiving faxes..... 63

- Receive reduce 65
- Two-sided reception..... 64

Reception mode

- A.M. mode..... 27, 63
- AUTO mode 27, 63
- MAN. mode 27, 63

Remote reception..... 39

Reports

- Group list..... 85
- Junk fax # list 86
- Passcode list..... 86
- Telephone # list..... 85
- Timer list 85
- Transaction reports 89
- Transmissions activity report 85, 88
- User program list..... 87

Resolution 55

Ringing volume 17

RSPF..... 13

- Document feeder cover..... 13
- Document feeder tray 13
- Exit area..... 13
- Original guides 13

S

Specifications 92

Storing numbers

- Group keys..... 45
- Rapid key dialing..... 42
- Speed dialing 42

T

TEL jack 13

Transmission mode

- Direct transmission 26
- Memory transmission..... 26

Troubleshooting 90

INDEX BY PURPOSE

Fax setup

Connecting the telephone line cord.....	11
Daylight saving time setting	25
Dial mode	31
Distinctive ringing	41
Entering your name and fax number.....	21
How to enter characters	20
Index function	36
Number of recall times	32
Number of rings for auto reception.....	28
Number of rings for manual reception	29
Recall interval	34
Reception mode	27
Reception paper size	29
Remote reception	39
Resolution priority	37
Setting the date and time	22
Transmission mode.....	26
Tray selection.....	30

Faxes, sending and receiving

Dialing

- Chain dialing	60
- Direct keypad dialing	59
- Redialing	61
- Speed dialing	59
- Using the [SPEAKER] key	60
Receiving faxes.....	63
- Manual receiving	66
- Optional reception settings	64
Sending originals	
- Dialing and transmitting	59
- Manual sending.....	66
- Optional transmission settings	54
- Setting the original	52

Special functions

Anti junk fax.....	81
Broadcasting	71
Data transfer	68
Memory polling.....	75
Polling	73
Polling security	77
Reservation	70
Serial polling.....	74
Timer operations	79

Storing/settings

Clear numbers	
- Group keys.....	47
- Rapid key dialing.....	44
- Speed dialing	44
Contrast.....	55
Enter characters.....	20
Original size	54
Resolution	55
Storing numbers	
- Group key.....	45
- Rapid key dialing.....	42
- Speed dialing	42

MEMO

MEMO

MEMO

NOTICE FOR USERS IN CANADA

"NOTICE : This product meets the applicable Industry Canada technical specifications."

"NOTICE : The Ringer Equivalence Number is an indication of the maximum number of devices allowed to be connected to a telephone interface. The termination on an interface may consist of any combination of devices subject only to the requirement that the sum of the RENs of all the devices does not exceed five."

The REN of this equipment is indicated on the copying machine.
The registration number is indicated on the fax printed circuit board and on the copying machine.

This Class B digital apparatus complies with Canadian ICES-003.

AVIS POUR NOS UTILISATEURS AU CANADA

AVIS : Le présent matériel est conforme aux spécifications techniques applicables d'Industrie Canada.

Remarque : L'indice d'équivalence de la sonnerie (IES) sert à indiquer le nombre maximal de terminaux qui peuvent être raccordés à une interface téléphonique. La terminaison d'une interface peut consister en une combinaison quelconque de dispositifs, à la seule condition que la somme d'indices d'équivalence de la sonnerie de tous les dispositifs n'excède pas 5.

L'indice d'équivalence de la sonnerie (IES) de cet équipement est indiqué sur le copieur.
Le numéro d'enregistrement est indiqué sur la carte à circuit imprimé du télécopieur et sur le copieur.

Cet appareil numérique de la classe B est conforme à la norme NMB-003 du Canada.

Sharp Electronics of Canada Ltd.
335 Britannia Road East,
Mississauga, Ontario, L4Z 1W9
Canada

SHARP[®]

SHARP ELECTRONICS CORPORATION

1 Sharp Plaza, Mahwah, New Jersey 07430-1164.

www.sharppusa.com

SHARP ELECTRONICS OF CANADA LTD.

335 Britannia Road East, Mississauga, Ontario, L4Z 1W9

SHARP CORPORATION



This manual has been printed using a vegetable-based soy oil ink
to help protect the environment.

Printed on 100% post-consumer recycled paper

PRINTED IN CHINA
2007M KS1
TINSE1864QSZZ

SHARP®



NETWORK EXPANSION KIT

SOFTWARE SETUP GUIDE (for network printer)

	Page
• SAFETY STANDARDS	2
• INTRODUCTION	3
• BEFORE INSTALLATION	5
• SETUP IN A WINDOWS ENVIRONMENT	10
• SETUP IN A MACINTOSH ENVIRONMENT	19

SAFETY STANDARDS

Shielded cables must be used with this equipment to maintain compliance with standards.

For users in the USA

This device complies with Part 15 of the FCC rules. Operation is subject to the following two conditions: (1) This device may not cause harmful interference, and (2) this device must accept any interference received, including interference that may cause undesired operation.

WARNING:

FCC Regulations state that any unauthorized changes or modifications to this equipment not expressly approved by the manufacturer could void the user's authority to operate this equipment.

Note:

This equipment has been tested and found to comply with the limits for a Class B digital device, pursuant to Part 15 of the FCC Rules. These limits are designed to provide reasonable protection against harmful interference in a residential installation. This equipment generates, uses and can radiate radio frequency energy and, if not installed and used in accordance with the instructions, may cause harmful interference to radio communications.

However, there is no guarantee that interference will not occur in a particular installation. If this equipment does cause harmful interference to radio or television reception, which can be determined by turning the equipment off and on, the user is encouraged to try to correct the interference by one or more of the following measures:

- Reorient or relocate the receiving antenna.
- Increase the separation between the equipment and receiver.
- Connect the equipment into an outlet on a circuit different from that to which the receiver is connected.
- Consult the dealer or an experienced radio/TV technician for help.

Notice for Users in Canada

This Class B digital apparatus complies with Canadian ICES-003.

Cet appareil numérique de la classe B est conforme à la norme NMB-003 du Canada.

Notice for Users in U.S.A.

Declaration of Conformity

SHARP Network Expansion Kit, AR-NB2 A

This device complies with Part 15 of the FCC Rules. Operation is subject to the following two conditions: (1) This device may not cause harmful interference, and (2) this device must accept any interference received, including interference that may cause undesired operation.

Responsible Party: SHARP ELECTRONICS CORPORATION

Sharp Plaza, Mahwah, New Jersey 07430

TEL: 1-800-BE-SHARP

INTRODUCTION

This manual explains how to configure network settings and install and configure the software to enable the machine to be used as a network printer.

Trademark acknowledgments

- Microsoft®, Windows®, Windows® 98, Windows® Me, Windows® 2000, Windows® XP, Windows Server® 2003, Windows Vista® and Internet Explorer® are registered trademarks or trademarks of Microsoft Corporation in the U.S.A. and other countries.
- PostScript is a registered trademark of Adobe Systems Incorporated.
- Macintosh, Mac OS, AppleTalk, EtherTalk and LaserWriter are trademarks of Apple Inc., registered in the U.S. and other countries.
- Adobe, the Adobe logo, Acrobat, the Adobe PDF logo, and Reader are registered trademarks or trademarks of Adobe Systems Incorporated in the United States and other countries.
- PCL is a registered trademark of the Hewlett-Packard Company.
- IBM, PC/AT, and PowerPC are trademarks of International Business Machines Corporation.
- All other trademarks and copyrights are the property of their respective owners.

SOFTWARE LICENSE

The SOFTWARE LICENSE will appear when you install the software from the CD-ROM. By using all or any portion of the software on the CD-ROM or in the machine, you are agreeing to be bound by the terms of the SOFTWARE LICENSE.



- The explanations of screens and procedures in this manual are primarily for Windows® XP in Windows® environments, and Mac OS X v10.4 in Macintosh environments. The screens may vary in other versions of the operating systems.
- The explanations in this manual are based on the North American version of the software. Versions for other countries and regions may vary slightly from the North American version.
- This manual refers to the digital multifunctional system AR-208S/208D as "the machine".
- Where "XX-XXXX" appears in this manual, please substitute the name of your model.
- The PS3 expansion kit (AR-PK1N) mentioned in this manual is an option.

The display screens, messages, and key names shown in the manual may differ from those on the actual machine due to product improvements and modifications.

CONTENTS

SAFETY STANDARDS	2
INTRODUCTION	3

BEFORE INSTALLATION

CD-ROMS AND SOFTWARE	5
● CD-ROMS IN THE NETWORK EXPANSION KIT	5
● SYSTEM REQUIREMENTS	7
● SOFTWARE REQUIREMENTS.....	7
CONNECTING TO A NETWORK	8
CHECKING THE IP ADDRESS	8
● HOW TO RESET THE NETWORK EXPANSION KIT	8
USER PROGRAMS FOR THE NETWORK EXPANSION KIT	9

SETUP IN A WINDOWS ENVIRONMENT

INSTALLING THE SOFTWARE	10
● INSTALLING THE PRINTER DRIVER	10
● SHARING THE PRINTER USING WINDOWS NETWORKING	13
● INSTALLING THE PRINTER STATUS MONITOR.....	15
● INSTALLING THE PS DISPLAY FONTS.....	16
USING THE PPD FILE	17
● Installing the resident font information for PPD (only when the PPD file is installed in Windows 98/Me)	17
CONFIGURING THE PRINTER DRIVER	18

SETUP IN A MACINTOSH ENVIRONMENT

MAC OS X	19
MAC OS 9.0 - 9.2.2	23

BEFORE INSTALLATION

CD-ROMS AND SOFTWARE

CD-ROMS IN THE NETWORK EXPANSION KIT

The network expansion kit contains the following four CD-ROMs: "Software CD-ROM" (Disc 1), "Software CD-ROM" (Disc 2), "Sharpdesk" (Disc 1) and "Sharpdesk" (Disc 2).



The printer driver, Printer Status Monitor and Printer Administration Utility on the "Software CD-ROM" cannot be used when the machine is connected to your computer by a USB.

"Software CD-ROM" (Disc 1)

The "Software CD-ROM" (Disc 1) contains the following software programs:

Software for Windows

- **Printer driver**

These allow the machine to be used as a printer.

- **PCL6 and PCL5e printer driver**

The machine supports the Hewlett-Packard PCL6 and PCL5e printer control languages. It is recommended that you use the PCL6 printer driver. If you have a problem printing from older software using the PCL6 printer driver, use the PCL5e printer driver.

- **PS printer driver**

The PS printer driver supports the PostScript 3 page description language developed by Adobe Systems Incorporated.

- **PPD driver**

The PPD driver enables the machine to use the standard Windows PS printer driver.

- **Printer Status Monitor**

This allows you to check the status of the network printer on your computer screen.

"Software CD-ROM" (Disc 2)

The "Software CD-ROM" (Disc 2) contains the following software programs:

Software for Windows

- **Printer Administration Utility**

This allows the administrator to monitor the machine and configure machine settings from a computer. To install and use the Printer Administration Utility, see the Readme file and the manual in PDF format on the "Software CD-ROM" (Disc 2). The Readme file and manual are in the following folder on the CD-ROM. (Substitute the letter of your CD-ROM drive for "R" in the following path.)

R:\Sadmin\Documents\EnglishA

- **Online manuals**

Manuals in PDF format that are viewed using Adobe Acrobat Reader.

Software for Macintosh

- **PPD file**

This is the printer description file which enables the machine to be used as a PostScript 3 compatible printer. The PS3 expansion kit is required to use the machine in a Macintosh environment.

- **Online manuals**

Manuals in PDF format that are viewed using Adobe Acrobat Reader.

"Sharpdesk" CD-ROMs (for Windows)

The "Sharpdesk" CD-ROM consists of 2 discs. Sharpdesk is a desktop document management application that makes it easy to start applications and file documents and images.

For information on the "Sharpdesk" CD-ROMs and the procedure for installing Sharpdesk, see operation manual for network scanner (PDF format).

SYSTEM REQUIREMENTS

Before installing the software described in this manual, make sure that your computer satisfies the following requirements.

	Windows	Macintosh
Operating system*	Windows 98, Windows Me, Windows 2000 Professional, Windows XP Professional, Windows XP Home Edition, Windows Server 2003, Windows Vista	Mac OS 9.0 to 9.2.2, Mac OS X v10.1.5, Mac OS X v10.2.8, Mac OS X v10.3.9, Mac OS X v10.4 to 10.4.10
Computer type	IBM PC/AT compatible computer Equipped with a 10Base-T/100Base-TX LAN board.	An environment in which any of the operating systems listed above can fully operate (including Macintosh computers with an Intel processor).
Display	800 x 600 resolution (SVGA) with 256 colors or higher (32,000 colors (16 bit) or higher is recommended)	
Other hardware requirements	An environment that allows any of the above operating systems to fully operate.	

* Printing is not possible in MS-DOS mode.

SOFTWARE REQUIREMENTS

The following requirements must be met to use the software described in this manual.

Operating system environment	Software	Required expansion kits
Windows	PCL6 printer driver, PCL5e printer driver	—
	PS printer driver, PPD driver	PS3 expansion kit
	Printer Status Monitor	—
	Printer Administration Utility	
Macintosh	Macintosh PPD driver	PS3 expansion kit

CONNECTING TO A NETWORK

After the network expansion kit has been installed in the machine, connect a LAN cable to the LAN connector of the network expansion kit.

Use a network cable that is shielded.

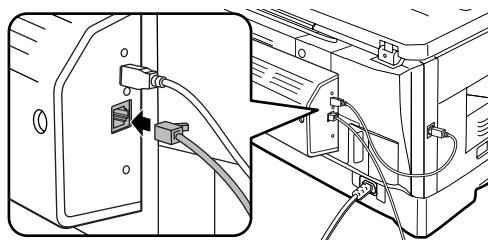

CHECKING THE IP ADDRESS

To check the IP address of the machine, hold down the status button on the network expansion kit at least 2 seconds to print out a Printer Setting List.

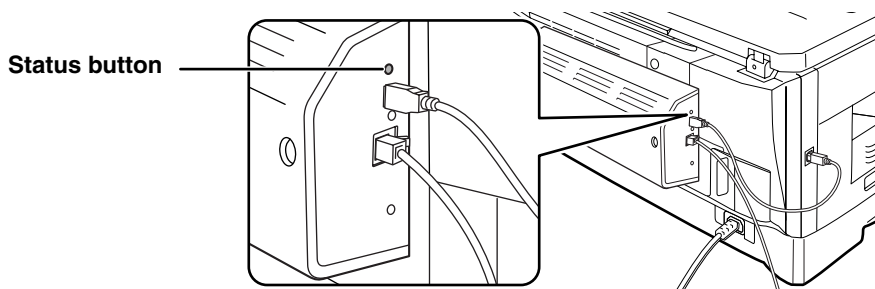

HOW TO RESET THE NETWORK EXPANSION KIT

To reset the network expansion kit, turn on the power while holding down the status button on the network expansion kit. Continue to hold down the status button until a beep sounds.



Network scanner destination information and scanning settings will remain after the network expansion kit is reset, however, the network settings and printer settings will revert to the factory default settings.

USER PROGRAMS FOR THE NETWORK EXPANSION KIT

When the network expansion kit is installed in the machine, the following programs are added to the user programs for Print mode.

The IP address and other network settings are configured using these user programs.



The procedure for selecting a user program setting is explained in "SELECTING A SETTING FOR A USER PROGRAM" in the operation manual.

Additional user programs for Print mode



Program number	Program name	Settings (factory default settings appear in bold)	Explanation
4	ENABLE TCP/IP	1: YES 2: NO	This program must be enabled to use the machine on a TCP/IP network. "IP ADDRESS SETTING" must also be configured. This program is initially enabled (factory default setting).
5	ENABLE DHCP	1: YES 2: NO	If "YES" is selected (factory default setting) and the machine is connected to a TCP/IP network, the IP address will be acquired automatically. If you will manually assign an IP address using "IP ADDRESS SETTING", select "NO".
6	IP ADDRESS SETTING	<ul style="list-style-type: none"> • IP ADDRESS • SUBNETMASK • DEFAULT GATEWAY 	This program is used to set the IP address (IP address, Subnet Mask, and Gateway) of the machine when TCP/IP protocol is used on the network. When "ENABLE DHCP" is selected, the machine will obtain an IP address automatically. This is the factory default setting.
7	ENABLE NETWARE	1: YES 2: NO	This program must be enabled to use the machine on a network that uses NetWare protocol. This program is initially enabled (factory default setting).
8	ENABLE ETHERTALK	1: YES 2: NO	This program must be enabled to use the machine on a network that uses EtherTalk protocol. This program is initially enabled (factory default setting).
9	ENABLE NETBEUI	1: YES 2: NO	This program must be enabled to use the machine on a network that uses NetBEUI protocol. This program is initially enabled (factory default setting).

SETUP IN A WINDOWS ENVIRONMENT

INSTALLING THE SOFTWARE

INSTALLING THE PRINTER DRIVER

1 Insert the "Software CD-ROM" (Disc 1) into your computer's CD-ROM drive.

2 Click the "start" button, click "My Computer" (), and then double-click the CD-ROM icon ().

- In Windows Vista, click the "Start" button, click "Computer", and then double-click the "CD-ROM" icon.
- In Windows 98/Me/2000, double-click "My Computer" and then double-click the CD-ROM icon.

3 Double-click the "setup" icon (). In Windows Vista, if a message screen appears asking you for confirmation, click "Allow".

4 The "SOFTWARE LICENSE" window will appear. Make sure that you understand the contents of the license agreement, and then click the "Yes" button.



You can show the "SOFTWARE LICENSE" in a different language by selecting the desired language from the language menu. To install the software in the selected language, continue the installation with that language selected.

5 Read the message in the "Welcome" window and then click the "Next" button.

6 Click the "Printer Driver" button. To view information on the software, click the "Display Readme" button.

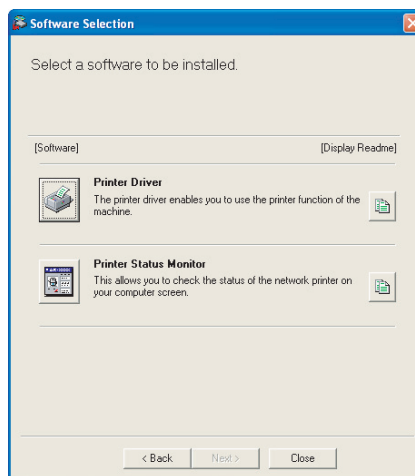

7 Click the "Standard installation" button.

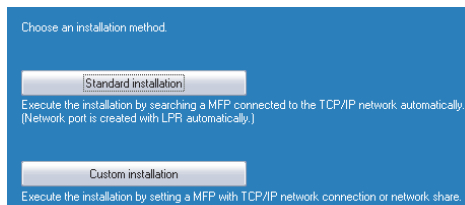

When "Custom installation" is selected, you can change any of the items below. When "Standard installation" is selected, the installation will take place as indicated below.

- Machine connection method: LPR Direct Print
 - Set as default printer: Yes
 - Printer driver name: Cannot be changed
 - PCL printer display fonts: Installed
- If you selected "Custom installation", select "LPR Direct Print" and click the "Next" button.

If you selected other than "LPR Direct Print", see "[SHARING THE PRINTER USING WINDOWS NETWORKING](#)" (p.13).

8 Printers connected to the network are detected. Select the machine and click the "Next" button.

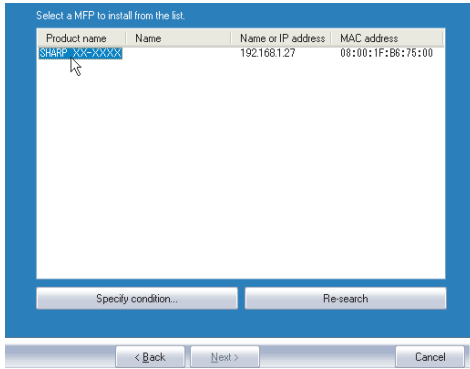

Note If the machine is not found, make sure that the machine is powered on and connected to your computer and then search again. If the machine is still not found, use the custom installation procedure to directly specify the IP address.

9 A confirmation window appears. Check the contents and then click the "Next" button.

10 When the printer driver selection window appears, select the printer driver to be installed and click the "Next" button.

Select the checkboxes of the printer drivers to be installed.

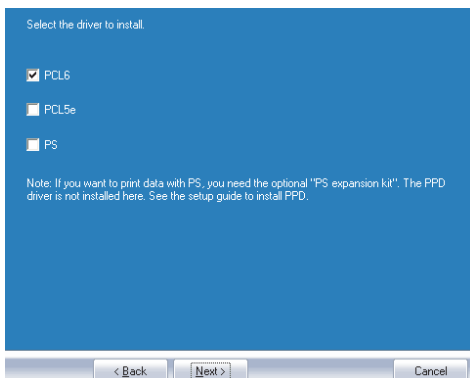

Note To use the PS printer driver, the PS3 expansion kit must be installed.

11 Select whether or not you wish the printer to be your default printer and click the "Next" button.

If you are installing multiple printer drivers, select the printer that you wish to use as your default printer.

If you do not wish to set either printer driver as the default printer, select "No".

Note If you clicked the "Custom installation" button in step 7, the following windows will appear.

- **Printer name window**
If you wish to change the printer name, enter the desired name and click the "Next" button.
- **Window confirming installation of the display fonts**
To install the display fonts for the PCL printer driver, select "Yes" and click the "Next" button. If you are not installing the PCL printer driver (you are installing the PS printer driver), select "No" and click the "Next" button.

12 Follow the on-screen instructions.

Read the message in the window that appears and click the "Next" button. Installation begins.

- **If you are using Windows 2000/XP/Server 2003**
If a warning message regarding the Windows logo test or digital signature appears, be sure to click the "Continue Anyway" or "Yes" button.
- **If you are using Windows Vista**
If a security warning window appears, be sure to click "Install this driver software anyway".

13 When the installation completed screen appears, click the "OK" button.

14 Click the "Close" button.



After the installation, a message prompting you to restart your computer may appear. In this case, click the "Yes" button to restart your computer.

This completes the installation of the software.

- After installation, see "[CONFIGURING THE PRINTER DRIVER](#)" (p.18) to check the printer driver settings.
- To install the Printer Status Monitor, see "[INSTALLING THE PRINTER STATUS MONITOR](#)" (p.15).



If you installed the PS printer driver, the PS display font can be installed from the "PRINTER UTILITIES" CD-ROM that accompanied the PS3 expansion kit. ([p.16](#))

SHARING THE PRINTER USING WINDOWS NETWORKING

If the machine will be used as a shared printer on a network, follow these steps to install the printer driver in the client computer.



To configure the appropriate settings in the print server, see the operation manual or help file of your operating system.
 "Print server" as explained here, is a computer that is directly connected to the machine, and a "Client" is any other computer that is connected to the same network.

1 Insert the "Software CD-ROM" (Disc 1) into your computer's CD-ROM drive.

2 Click the "start" button, click "My Computer" (), and then double-click the CD-ROM icon ().

- In Windows Vista, click the "Start" button, click "Computer", and then double-click the "CD-ROM" icon.
- In Windows 98/Me/2000, double-click "My Computer" and then double-click the CD-ROM icon.

3 Double-click the "setup" icon (). In Windows Vista, if a message screen appears asking you for confirmation, click "Allow".

4 The "SOFTWARE LICENSE" window will appear. Make sure that you understand the contents of the license agreement, and then click the "Yes" button.



You can show the "SOFTWARE LICENSE" in a different language by selecting the desired language from the language menu. To install the software in the selected language, continue the installation with that language selected.

5 Read the message in the "Welcome" window and then click the "Next" button.

6 Click the "Printer Driver" button. To view information on the software, click the "Display Readme" button.

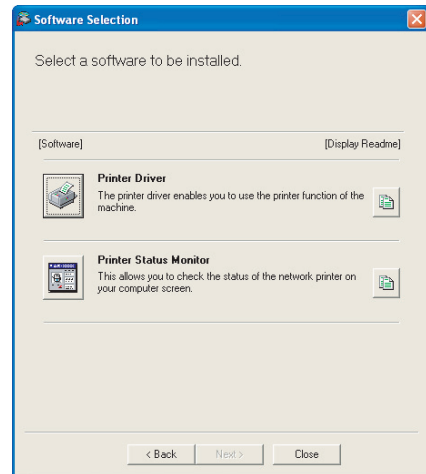

7 Click the "Custom installation" button.

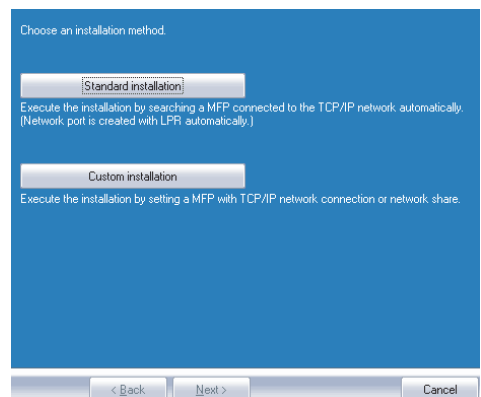

8 Select "Shared Printer" and click the "Next" button.

9 For the port to be used, select the machine set as a shared printer, and click the "Next" button.

If you are using Windows 98/Me/2000/XP, you can also click the "Add Network Port" button and select the printer to be shared by browsing the network in the window that appears. (In Windows Vista, the "Add Network Port" button does not appear.)

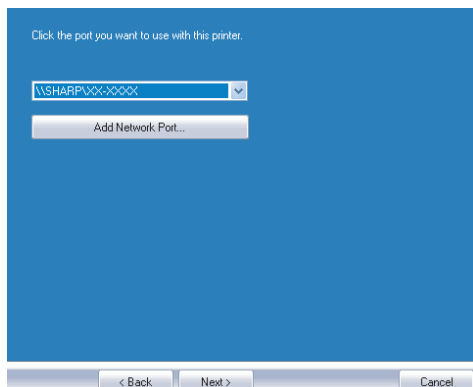

If the shared printer does not appear in the list, check the settings in the printer server.

10 When the model selection window appears, select model name of your machine and click the "Next" button.

11 When the printer driver selection window appears, select the printer driver to be installed and click the "Next" button.

Be sure to select the same printer driver as the printer driver used in the print server (the machine).

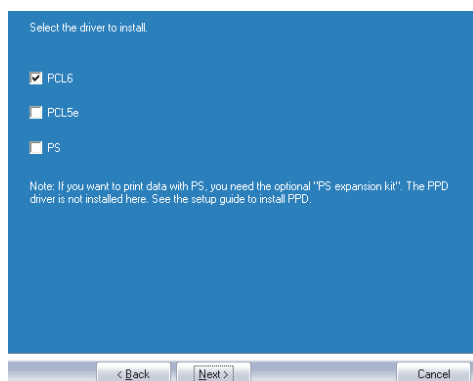

12 Follow the on-screen instructions.



• If you are using Windows 2000/XP/Server 2003

If a warning message regarding the Windows logo test or digital signature appears, be sure to click the "Continue Anyway" or "Yes" button.

• If you are using Windows Vista

If a security warning window appears, be sure to click "Install this driver software anyway".

13 When the installation completed screen appears, click the "OK" button.

14 Click the "Close" button in the window of step 6.



After the installation, a message prompting you to restart your computer may appear. If this message appears, click the "Yes" button to restart your computer.

This completes the installation of the software.

- After installation, see "[CONFIGURING THE PRINTER DRIVER](#)" (p.18) to check the printer driver settings.
- To install the Printer Status Monitor, see "[INSTALLING THE PRINTER STATUS MONITOR](#)" (p.15).



If you installed the PS printer driver, the PS display font can be installed from the "PRINTER UTILITIES" CD-ROM that accompanied the PS3 expansion kit. ([p.16](#))

INSTALLING THE PRINTER STATUS MONITOR

1 Insert the "Software CD-ROM" (Disc 1) into your computer's CD-ROM drive.

2 Click the "start" button, click "My Computer" (), and then double-click the CD-ROM icon ().

- In Windows Vista, click the "Start" button, click "Computer", and then double-click the "CD-ROM" icon.
- In Windows 98/Me/2000, double-click "My Computer" and then double-click the CD-ROM icon.

3 Double-click the "setup" icon (). In Windows Vista, if a message screen appears asking you for confirmation, click "Allow".

4 The "SOFTWARE LICENSE" window will appear. Make sure that you understand the contents of the license agreement, and then click the "Yes" button.



You can show the "SOFTWARE LICENSE" in a different language by selecting the desired language from the language menu. To install the software in the selected language, continue the installation with that language selected.

5 Read the message in the "Welcome" window and then click the "Next" button.

6 Click the "Printer Status Monitor" button. To view information on the software, click the "Display Readme" button.

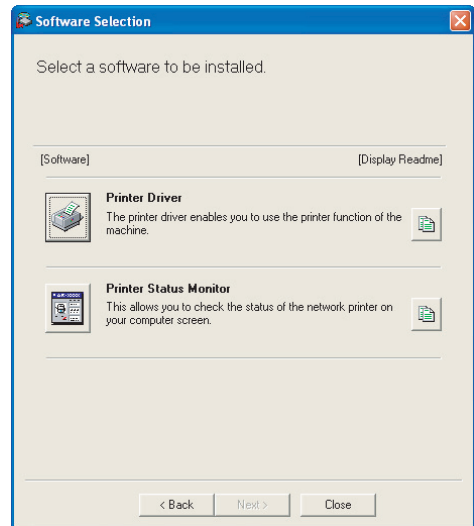

7 Follow the on-screen instructions.

8 When the installation completed screen appears, click the "Finish" button.

To have the Printer Status Monitor start automatically when your computer is started, select the "Add this program to your Startup folder" checkbox.

9 Click the "Close" button in the window of step 6.



After the installation, a message prompting you to restart your computer may appear. If this message appears, click the "Yes" button to restart your computer.

This completes the installation.

For the procedures for using the Printer Status Monitor, see the Help file. Follow these steps to view the Help file:



Click the Windows "start" button, select "All Programs" ("Programs" in Windows 98/Me/2000), select "SHARP Printer Status Monitor" and then select "Help".

INSTALLING THE PS DISPLAY FONTS

The fonts used by the PS printer driver are contained in the "PRINTER UTILITIES" CD-ROM that accompanied the PS3 expansion kit. Install these fonts as needed for the PS printer driver.

1 Insert the "PRINTER UTILITIES" CD-ROM into your computer's CD-ROM drive.

If your computer is configured for auto start on the CD-ROM, proceed to step 4.

2 Click the "start" button, click "My Computer" (), and then double-click the CD-ROM icon ().

- In Windows Vista, click the "Start" button, click "Computer", and then double-click the "CD-ROM" icon.
- In Windows 98/Me/2000, double-click "My Computer", and then double-click the CD-ROM icon.

3 Double-click the "setup" icon (). In Windows Vista, if a message screen appears asking you for confirmation, click "Allow".



If the language selection screen appears after you double click the "setup" icon, select the language that you wish to use and click the "Next" button. (Normally the correct language is selected automatically.)

4 Select the "PS Display Font" checkbox and click the "Next" button.



Do not select "PS Printer Driver". The PS printer driver for the machine should only be installed from the CD-ROM that accompanies the network expansion kit.

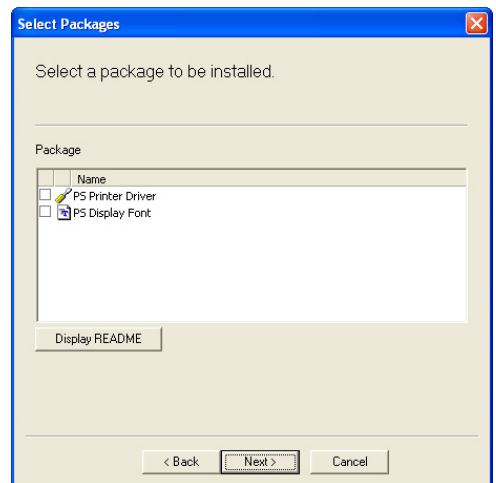

5 Follow the on-screen instructions.

USING THE PPD FILE

The PPD file enables the machine to print using the standard PS driver of the operating system, and can be used when the optional PS3 expansion kit is installed. Install the PPD file as needed.

Use the Add Printer Wizard in Windows to install the PPD file.

Be sure to read the Readme file before installing the PPD file. The Readme file is in the "EnglishA" folder. For the location of the folder, see step 4.

1 Click the "start" button, click "Control Panel", click "Printers and Other Hardware", and then click "Printers and Faxes".

- In Windows Vista, click the "Start" button, click "Control Panel" and then click "Printer".
- In Windows Server 2003, click the "Start" button and then click "Printers and Faxes".
- In Windows 98/Me/2000, click the "Start" button, select "Settings", and then click "Printers".

2 Insert the "Software CD-ROM" (Disc 1) into your computer's CD-ROM drive.

3 Click "Add a printer" in "Printer Tasks".

- In Windows Vista, click "Add a printer" from the tool bar.
- In Windows 98/Me/2000, double-click the "Add Printer" icon. The "Add Printer Wizard" will appear.

4 Follow the on-screen instructions.

When you are asked to specify the path of the PPD file, enter the path as follows. (Substitute the letter of your CD-ROM drive for "R" in the following paths.)

Operating system	PPD file path
Windows 98/Me	R:\Drivers\Printer \EnglishA\PPD\9xMe
Windows 2000/XP/ Server 2003/Vista	R:\Drivers\Printer \EnglishA\PPD\2KXPVista

Installing the resident font information for PPD (only when the PPD file is installed in Windows 98/Me)

If you have installed the PPD file in Windows 98/Me and will be using the resident font, you must install resident font information for PPD. Follow the procedure below to install the resident fonts information.



- If you are using Windows 2000, Windows XP, Windows Server 2003 or Windows Vista, the resident font information is automatically installed when the PPD file is installed.
- Before installing the resident font information, be sure to install the PPD file.

1 Insert the "Software CD-ROM" (Disc 1) into your computer's CD-ROM drive.

2 Double-click "My Computer" (), and then double-click the CD-ROM icon ().

3 Double-click the "Drivers" folder, the "Printer" folder, the "EnglishA" folder, the "PPD" folder, the "9xMe" folder, and "PFMSSetup.exe".

4 Follow the on-screen instructions.

5 After the resident font information has been installed, restart your computer.



If printer resident fonts cannot be specified from the application software, the resident font information has not been installed or the information is not correct. In this case, reinstall the resident font information.

CONFIGURING THE PRINTER DRIVER

After installing the printer driver, you must configure the printer driver settings appropriately for the number of paper trays on the machine and the size of paper loaded in each tray.

1 Click the "start" button, click "Control Panel", click "Printers and Other Hardware", and then click "Printers and Faxes".

- In Windows Vista, click the "Start" button, click "Control Panel" and then click "Printer".
- In Windows Server 2003, click the "Start" button and then click "Printers and Faxes".
- In Windows 98/Me/2000, click the "Start" button, select "Settings", and then click "Printers".

2 Click the "SHARP XX-XXXX" printer driver icon and select "Properties" from the "File" menu.

- If you are using Windows 2000/XP/Server 2003/Vista, go to step 4.
- In Windows Vista, from the "Organize" menu select "Properties".

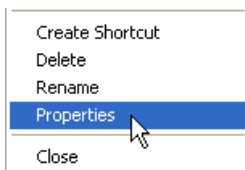

3 In Windows 98/Me, click the "Setup" tab.

4 Click the "Configuration" tab and set the printer configuration based on the options that have been installed.

Set the printer configuration properly. Otherwise, printing may not take place correctly.

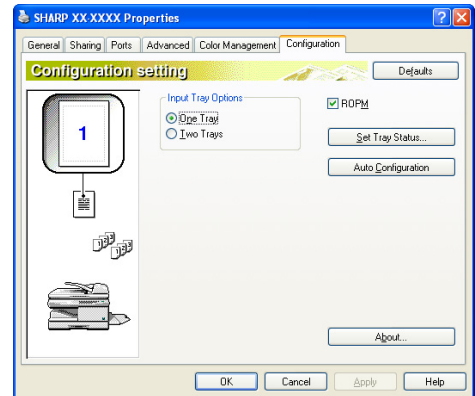

To automatically configure the settings based on the detected machine status, click the "Auto Configuration" button.

5 Click the "Set Tray Status" button and select the size of paper that is loaded in each tray.

Select a tray in the "Paper source" menu, and select the size of paper loaded in that tray from the "Set Paper Size" menu. Repeat for each tray.

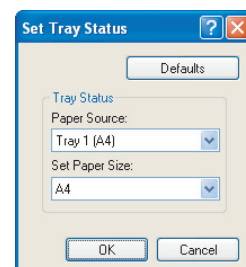

6 Click the "OK" button in the "Set Tray Status" window.

7 Click the "OK" button in the printer properties window.

SETUP IN A MACINTOSH ENVIRONMENT

This chapter explains how to install the PPD file to enable printing from a Macintosh and how to configure the printer driver settings.

- MAC OS X: this page
(v10.1.5, v10.2.8, v10.3.9, v10.4 - v10.4.10)
- MAC OS 9.0 - 9.2.2: page 23



To use the machine as a printer in a Macintosh environment, the PS3 expansion kit is necessary.

MAC OS X



The explanations of screens and procedures are primarily for Mac OS X v10.4. The screens may vary in other versions of the operating system.

1 Insert the "Software CD-ROM" (Disc 2) into your computer's CD-ROM drive.

2 Double-click the CD-ROM icon (📀) on the desktop.

3 Double-click the "MacOSX" folder.
Before installing the software, be sure to read "ReadMe First". "ReadMe First" is in the "US-English" folder in the "Readme" folder.

4 Double-click the folder corresponding to the versions of the operating system.

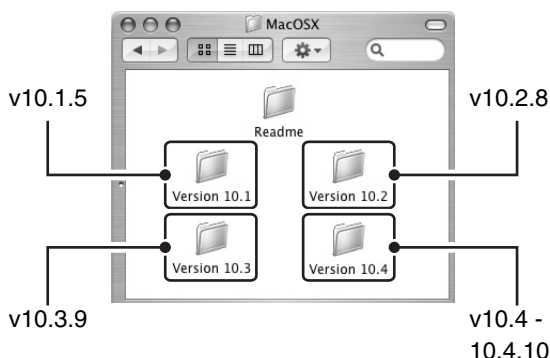

5 Double-click the "AR-NB2A" icon (🍌).



- If the "Authorization" window appears in Mac OS X v10.1.5, click the lock icon (🔒), enter the password, and click the "OK" button.
- If the "Authenticate" window appears in Mac OS X v10.2.8, enter the password and click the "OK" button.

6 Click the "Continue" button.



7 The License Agreement window will appear. Make sure that you understand the contents of the license agreement and then click the "Continue" button. A message will appear asking you if you agree to the terms of the license. Click the "Agree" button.

Note If the license appears in the different language, change the language in the language menu.

8 Select the hard drive where the PPD file will be installed and click the "Continue" button. Be sure to select the hard drive on which your operating system is installed.



9 Click the "Install" button. Installation begins.

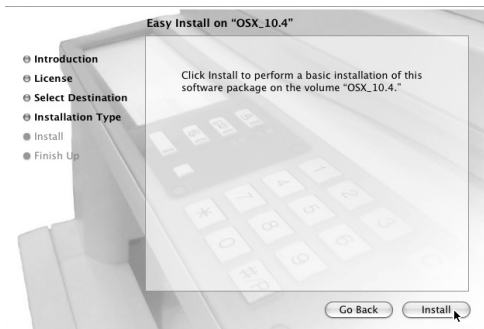

Note If the "Authenticate" window appears, enter the password and click the "OK" button.

10 When the message "The software was successfully installed" appears in the installation window, click the "Close" button.

This completes the installation of the software. Next, configure the printer driver settings.

11 Select "Utilities" from the "Go" menu. If you are using Mac OS X v10.1.5 or v10.2.8, select "Applications" from the "Go" menu.

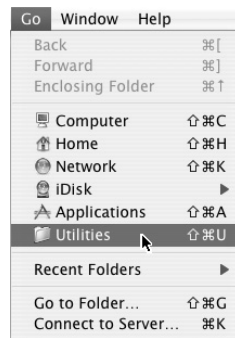

12 Double-click the "Printer Setup Utility" icon (🖨️). If you are using Mac OS X v10.1.5 or v10.2.8, double-click the "Utilities" folder and then double-click the "Print Center" icon.

Note If this is the first time you are installing a printer driver on your computer, a confirmation message will appear. Click the "Add" button.

13 Click "Add". If you are using Mac OS X v10.1.5, click the "Add Printer" button.



14 Configure the printer driver.

The procedure for configuring the printer driver varies depending on the operating system version. The procedure for versions 10.4 - 10.4.10 and the procedure for other versions are explained separately below.

v10.4 - 10.4.10

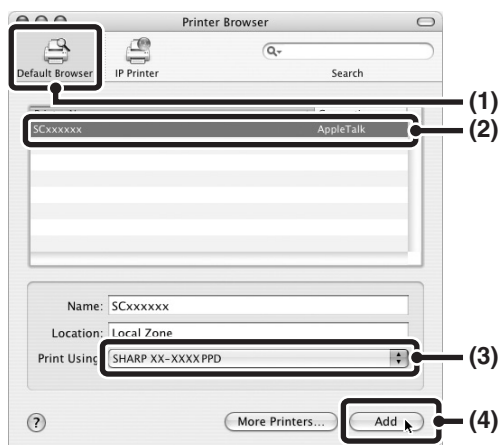

- (1) Click the "Default Browser" icon. If multiple AppleTalk zones are displayed, select the zone that includes the printer from the menu.
- (2) Click the machine's model name.
 - The machine's model name usually appears as "SCxxxxxx". ("xxxxxx" is a sequence of characters that varies depending on your model.)
 - The PPD file of the machine is automatically selected.
- (3) Make sure that the PPD file of your model is selected.
- (4) Click the "Add" button. The PPD file of the machine is automatically selected and the peripheral devices installed on the machine are detected and automatically configured.

10.1.5, v10.2.8, v10.3.9

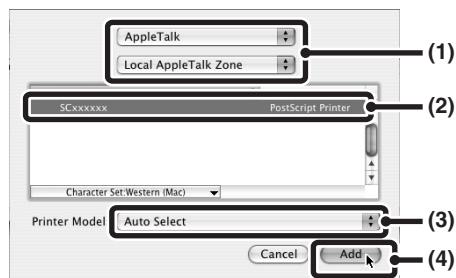

- (1) Select "AppleTalk". If multiple AppleTalk zones are displayed, select the zone that includes the printer from the menu.
- (2) Click the machine's model name. The machine's model name usually appears as "SCxxxxxx". ("xxxxxx" is a sequence of characters that varies depending on your model.)
- (3) Select the PPD file of the machine.
 - If you are using Mac OS X v10.1.5, select "Other". The PPD file selection window will appear. Click "Startup disk name" - "Library" - "Printers" - "PPDs" - "Contents" - "Resources" - "en.lproj" - "PPD file for your model", and then click the "Choose" button.
 - If you are using Mac OS X v10.2.8, select "Sharp" and click the PPD file of your model.
 - If you are using Mac OS X v10.3.9, select "Auto Select".
- (4) Click the "Add" button. If you are using Mac OS X v10.3.9, the PPD file of the machine is automatically selected and the peripheral devices installed on the machine are detected and automatically configured.



The PPD file is installed in the following folders on the startup disk.
"Library" - "Printers" - "PPDs" - "Contents" - "Resources" - "en.lproj"

If you are using Mac OS X v10.1.5, this completes the configuration of the printer driver. If you are using a version other than Mac OS X v10.1.5, go to the next step.

15 Display printer information.

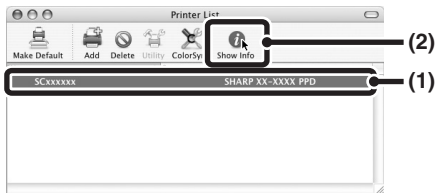

(1) Click the machine's name.

(2) Click "Show Info".

If you are using Mac OS X v10.2.8, select "Show Info" from the "Printers" menu.

16 Select the machine configuration.

If you selected "Auto Select" in (3) of step 14, the machine configuration is detected and automatically configured. Check the configured settings to make sure they are correct.

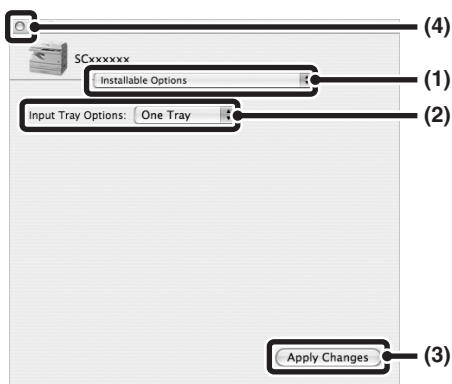

(1) Select "Installable Options".

(2) Select the options that are installed on the machine.

(3) Click the "Apply Changes" button.

(4) Click to close the window.

This completes the configuration of the printer driver.

MAC OS 9.0 - 9.2.2



If you are using Mac OS 9.0 to 9.2.2, make sure that "LaserWriter 8" has been installed and that the "LaserWriter 8" checkbox is selected in "Extensions Manager" in "Control Panels". If not, install it from the system CD-ROM supplied with your Macintosh computer.

1 Insert the "Software CD-ROM" (Disc 2) into your computer's CD-ROM drive.

2 Double-click the "CD-ROM" icon (📀) on the desktop.

3 Double-click the "MacOS" folder.

Before installing the software, be sure to read "ReadMe First". "ReadMe First" is in the "US-English" folder in the "Readme" folder.

4 Double-click the "Installer" icon (📦).

5 Click the "Install" button.



6 The License Agreement window will appear. Make sure that you understand the contents of the license agreement and then click the "Yes" button.

7 Read the message in the window that appears and click the "Continue" button.

Installation of the PPD file begins. After the installation, a message prompting you to restart your computer will appear. Click the "OK" button and restart your computer.

This completes the installation of the software. Next, configure the printer driver settings.

8 Select "Chooser" from the Apple Menu.

9 Create a printer.

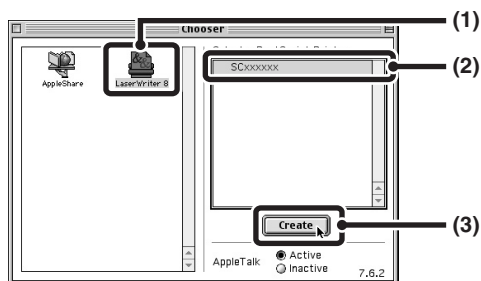

(1) Click the "LaserWriter 8" icon.

If multiple AppleTalk zones are displayed, select the zone that includes the printer.

(2) Click the machine's model name.

The machine's model name usually appears as "SCxxxxxx". ("xxxxxx" is a sequence of characters that varies depending on your model.)

(3) Click the "Create" button.

10 Select the PPD file.

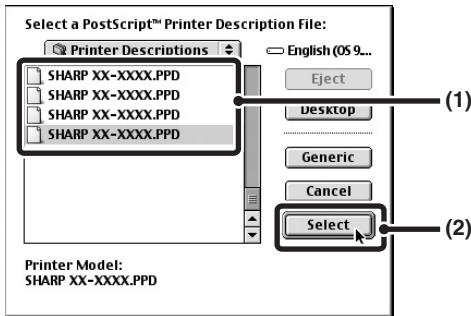

- (1) Click the PPD file for your model.
- (2) Click the "Select" button.



- If the above dialog box does not appear and you return to the "Chooser" dialog box, follow these steps to select the PPD file manually.
 - (1) Make sure that the machine is selected in the "Select a PostScript Printer" list, and then click the "Setup" button followed by the "Select PPD" button.
 - (2) Select the PPD file for your model and click the "Open" button.
 - (3) Click the "OK" button.
- The PPD file is installed in the "Printer Descriptions" folder in the "Extensions" folder.

11 Make sure that the machine is selected in the "Select a PostScript Printer" list and then click the "Setup" button.

12 Click the "Configure" button.

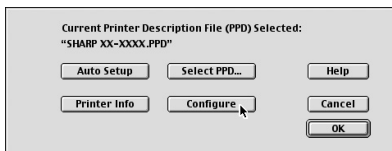

To automatically configure the settings based on the installed machine options that are detected, click the "Auto Setup" button.

13 Select the machine configuration.

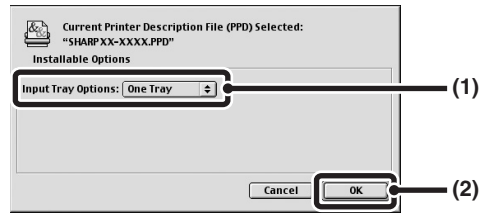

- (1) Select the options that are installed on the machine.
- (2) Click the "OK" button.

14 Click the "OK" button in the window of step 12 to close the window.

15 Click the close box (☐) to close the "Chooser".

This completes the configuration of the printer driver.

Installing the screen fonts

The screen fonts for Mac OS 9.0 - 9.2.2 are contained in the "Font" folder of the "PRINTER UTILITIES" CD-ROM that accompanies the PS3 expansion kit. Copy the fonts that you wish to install to the "System Folder" of the startup disk.



If you experience problems that may be due to the installed screen fonts, immediately delete the installed fonts from the system.

SHARP[®]
SHARP CORPORATION

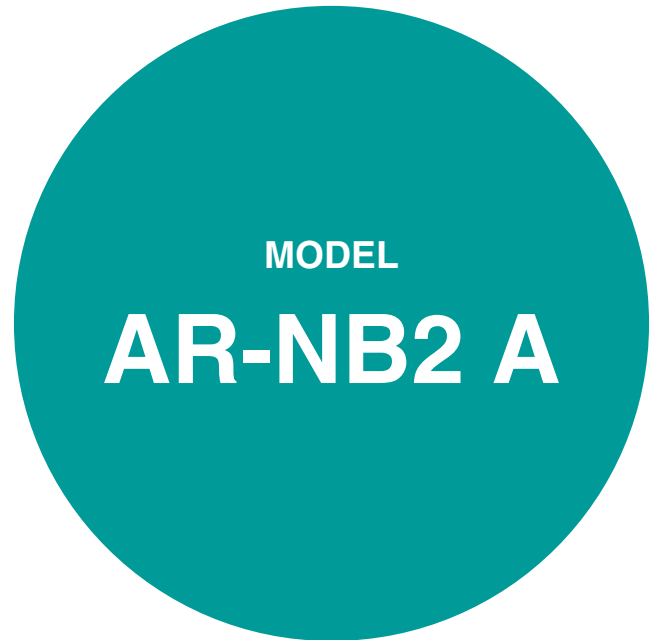

NETWORK EXPANSION KIT

OPERATION MANUAL
(for network scanner)

	Page
• INTRODUCTION	2
• BEFORE USING THE NETWORK SCANNER FUNCTION	4
• USING THE NETWORK SCANNER FUNCTION	17
• TROUBLESHOOTING	21
• SHARPDESK CD-ROM (for Windows)	25
• SPECIFICATIONS	29

INTRODUCTION

The optional network expansion kit (AR-NB2 A) enables the machine to be used as a network scanner.

- This manual only explains features that can be used when the optional network expansion kit is installed. For information on loading paper, replacing toner cartridges, clearing paper misfeeds, handling peripheral devices, and other copier-related information, please refer to your operation manual for the machine.
For information on the printer function that can be used when the network expansion kit is installed, see the online manual for the network printer that accompanies the network expansion kit.
- The explanations in this manual assume that the person who will install the product and the users of the product have a working knowledge of Microsoft Windows.
- This manual refers to the digital multifunctional system AR-208S/208D as "the machine".
- For information on the operating system, please refer to your operating system manual or the online Help function.
- The explanations of screens and procedures in this manual are for Windows XP. The screens may vary depending on your Windows version and settings.
- This manual refers to the Reversing Single Pass Feeder as the "RSPF".
- Where "XX-XXXX" appears in this manual, please substitute the name of your model.

Warranty

While every effort has been made to make this operation manual as accurate and helpful as possible, SHARP Corporation makes no warranty of any kind with regard to its content. All information included herein is subject to change without notice. SHARP is not responsible for any loss or damages, direct or indirect, arising from or related to the use of this operation manual.

Trademark Acknowledgments

- Sharpdesk is a trademark of Sharp Corporation.
- Microsoft®, Windows®, Windows® 98, Windows® Me, Windows® 2000, Windows® XP, Windows Server® 2003, Windows Vista® and Internet Explorer® are registered trademarks or trademarks of Microsoft Corporation in the U.S.A. and other countries.
- Netscape Navigator is a trademark of Netscape Communications Corporation.
- Adobe, the Adobe logo, Acrobat, the Adobe PDF logo, and Reader are registered trademarks or trademarks of Adobe Systems Incorporated in the United States and other countries.
- All other trademarks and copyrights are the property of their respective owners.

<p>The display screens, messages, and key names shown in the manual may differ from those on the actual machine due to product improvements and modifications.</p>
--

CONTENTS

INTRODUCTION 2

1

BEFORE USING THE NETWORK SCANNER FUNCTION

ABOUT THE NETWORK SCANNER FUNCTION.... 4
SETTINGS AND PROGRAMMING REQUIRED FOR THE NETWORK SCANNER FEATURE .. 5

- HOW TO ACCESS THE WEB PAGE AND VIEW HELP5

ABOUT THE WEB PAGE (FOR USERS)..... 6

- STORING SCANNING SETTINGS.....7
- STORING DESTINATIONS8

ABOUT THE WEB PAGE (FOR THE ADMINISTRATOR) 13

- BASIC SETTINGS FOR NETWORK SCANNING14
- VARIOUS SERVER SETTINGS15
- PROTECTING INFORMATION PROGRAMMED IN THE WEB PAGE ([Passwords])16

2

USING THE NETWORK SCANNER FUNCTION

BASIC TRANSMISSION PROCEDURE..... 17

- TRANSMISSION METHODS FOR SCAN TO E-MAIL18
- IMAGE ORIENTATION AND STANDARD ORIGINAL LOADING ORIENTATION20
- HOW TO ENTER CHARACTERS20

3

TROUBLESHOOTING

TROUBLESHOOTING 21

- DISPLAY MESSAGES22
- IF YOUR E-MAIL IS RETURNED22
- IMPORTANT POINTS WHEN USING SCAN TO E-MAIL23

CHECKING THE IP ADDRESS 24

- HOW TO RESET THE NETWORK EXPANSION KIT24

4

SHARPDESK CD-ROM (for Windows)

SOFTWARE PROGRAMS.....25

- SHARPDESK (Desktop Document Management Software)..... 25
- NETWORK SCANNER TOOL 25
- SHARP TWAIN AR/DM..... 25

USER'S GUIDES FOR SOFTWARE PROGRAMS26

INSTALLING THE SOFTWARE PROGRAM ..27

- INSTALLING SHARPDESK AND NETWORK SCANNER TOOL..... 27
- INSTALLING SHARP TWAIN AR/DM..... 28

UNINSTALLING THE SOFTWARE PROGRAM..28

- UNINSTALLING THE SOFTWARE PROGRAM FROM THE CONTROL PANEL 28

5

SPECIFICATIONS

1

BEFORE USING THE NETWORK SCANNER FUNCTION

ABOUT THE NETWORK SCANNER FUNCTION

When the network expansion kit is installed in the machine, a document or photo can be scanned into an image file and sent over a network or the Internet to a file server, e-mail destination, or your own computer. You can select from the following transmission methods as the destination where you wish to send the scanned image, depending on where you wish to send the scanned image data.

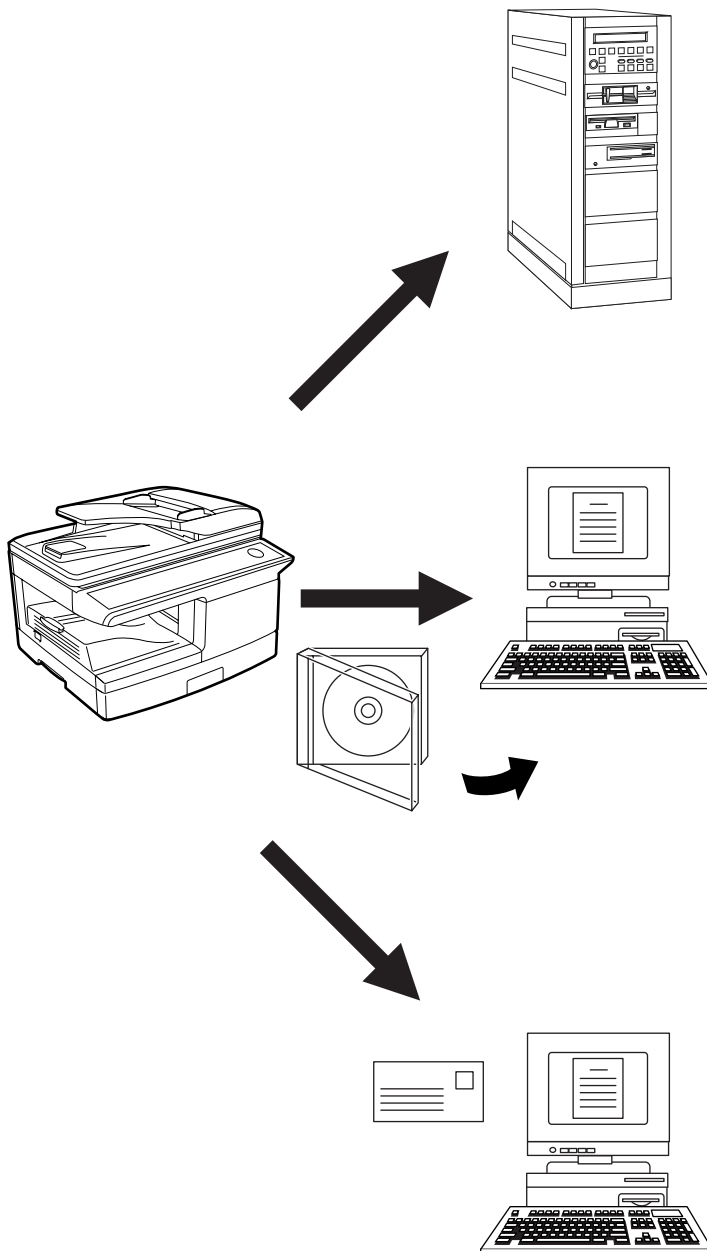

1. The scanned image can be sent to a memory storage device on a network (a designated directory on an FTP server). (This is called **"Scan to FTP"** in this manual.)
When sending a scanned image to an FTP server, an e-mail message can also be sent to a preset e-mail address to inform the recipient of the location of the scanned image data. (This is called **"Scan to FTP (Hyperlink)"** in this manual.)

2. A scanned image can be sent to a computer connected to the same network as the machine. (This is called **"Scan to Desktop"** in this manual.)
* Before Scan to Desktop can be performed, the software in the CD-ROM that accompanies the network expansion kit (AR-NB2 A) must be installed. For the procedure for installing the software, see the "[SHARPDESK CD-ROM \(for Windows\)](#)" (p.25).

3. The scanned image can be sent to an e-mail recipient. (This is called **"Scan to E-mail"** in this manual.)

SETTINGS AND PROGRAMMING REQUIRED FOR THE NETWORK SCANNER FEATURE

To use the Network Scanner feature, settings for the SMTP server, DNS server, and destination addresses must be configured.

To configure the settings, use a computer that is connected to the same network as the machine to access the machine's Web server. The Web page can be viewed with your Web browser (Internet Explorer 5.5 or later (Windows), or Netscape Navigator 6.0 or later).

HOW TO ACCESS THE WEB PAGE AND VIEW HELP

Use the following procedure to access the Web pages. [Help] can be clicked at the bottom of the menu frame to view information on the various function settings that can be operated remotely over the network from the machine's Web pages. For the settings of each function, see the explanations in Help.

1

1 Open the Web browser on your computer.

Supported browsers:
Internet Explorer 5.5 or later (Windows)
Netscape Navigator 6.0 or later

2 In the "Address" field of your Web browser, enter the IP address of the machine.

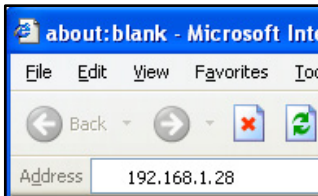

To check the IP address, see "[CHECKING THE IP ADDRESS](#)" (p.24).

When the connection is complete, the Web page will appear in your Web browser.

See "[ABOUT THE WEB PAGE \(FOR USERS\)](#)" (p.6)

3 Click [Help] under the menu frame.

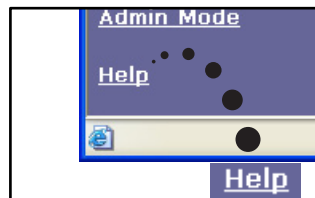

For an explanation of a function or setting in the Web page, click the corresponding item in the Help screen.

4 Close the Web page.

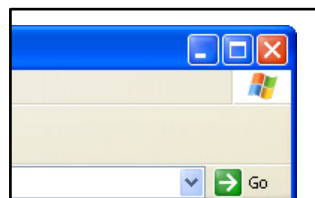

When you have finished using the Web page, click the  (close) button in the top right corner of the page.

ABOUT THE WEB PAGE (FOR USERS)

When you successfully connect to the Web server in the machine, the following page will appear in your browser. A menu frame appears on the left side of the page. When you click an item in the menu, a screen appears in the right frame that allows you to establish settings for that item.

For detailed explanations of the procedures for configuring settings, click [Help] in the menu frame.

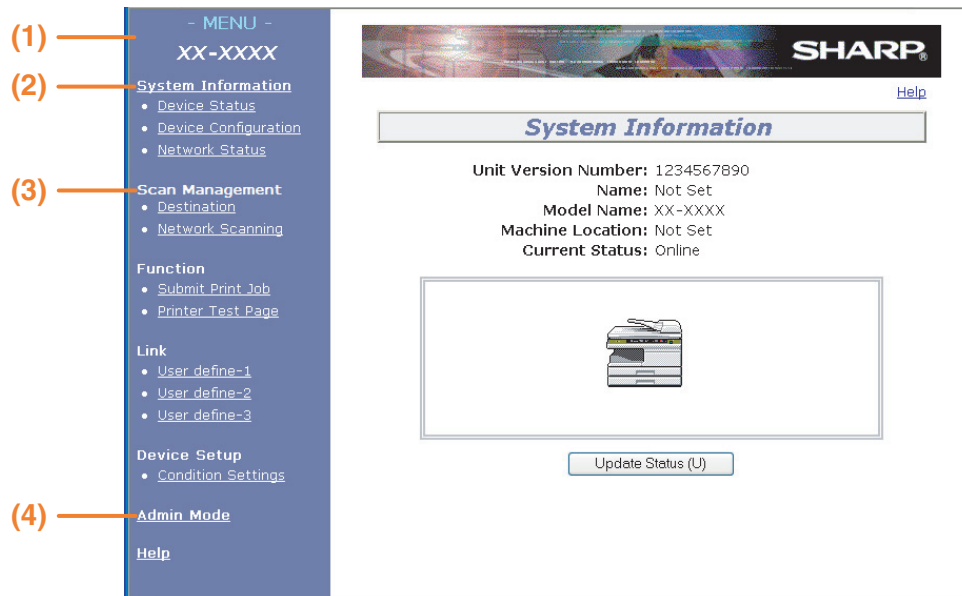

(1) Menu frame

The various settings appear in this frame. Click a menu item to configure the corresponding setting.

(2) System Information

This shows the model name and current status of the machine.

- Device Status
This shows information on the machine's paper trays and output trays, toner and other supplies, and the total sheet usage count. Out of paper and other warnings appear in red.
- Device Configuration
Shows what options are installed.
- Network Status
Shows general information as well as the status of TCP/IP, NetWare, AppleTalk, and NetBEUI.

(3) Scan Management

This is the base screen for storing, editing, and deleting destination information.

- Destination ([p.8](#))
Store destinations for Scan to FTP, Scan to FTP (Hyperlink), Scan to Desktop, and Scan to E-mail. You can also edit or delete previously stored destination information.
- Network Scanning
This section explains how to edit the scan mode and custom indexes.
 - Scan Mode
Scanning settings appropriate for the use can be stored.
☞ "[STORING SCANNING SETTINGS](#)" (p.7)
 - Custom Index
This enables to change custom index names. Click the [Submit] button to store the entered information as index names.
The custom index consists of six indexes. A 6-character index name can be stored for each index, allowing destinations to be grouped.

(4) Admin Mode

Click here to open the administrator Web page and enter the administrator user name and password.

☞ "[PROTECTING INFORMATION PROGRAMMED IN THE WEB PAGE \(\[Passwords\]\)](#)" (p.16)

☞ "[ABOUT THE WEB PAGE \(FOR THE ADMINISTRATOR\)](#)" (p.13)

STORING SCANNING SETTINGS

Sets of scan settings (color mode, resolution, file type, etc.) can be stored for use in various scanning applications. Each set of settings is called a "Scan Mode". When storing a destination, you can select one of the stored scanned modes. The settings of the selected scan mode will be used when you scan an image and send it to that destination (p.8 to 11).

1 Click "Network Scanning" in the menu frame of the Web page.



2 Click "Add" below the scan list.

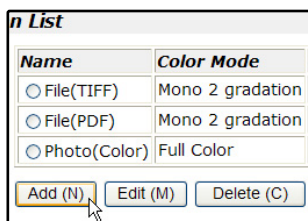

If you need to change the settings in a previously stored scan mode, select the scan mode and click "Edit". To delete a scan mode, select the scan mode and click "Delete".

3 Select the desired scanning settings.

Refer to the following table for information on each setting.

4 When you have finished selecting the settings, click "Submit".

The selected settings are stored.

Scan Mode settings

Item	Description	Default setting
Name	Enter a name for the scan mode (up to 32 characters).	—
Color Mode	Select Full Color, Grayscale, or Mono 2 gradation for the color mode.	Full Color
Resolution	Select the resolution.	75 dpi
Void Area	Select "On" to not scan the 4 mm around the edges of the image and instead attach a white border.	Off
Light Source	When "Mono 2 gradation" is selected for "Color Mode", select "Red", "Green", or "Blue" for the light source.	Green
File Type	Select "JPG", "PDF", or "TIFF" for the file type of the scanned image.	TIFF
Compression Mode	Select "None", "MH (G3)", or "MMR (G4)" for the compression mode of the scanned image.	None
Pages Per File	Select the number of pages per image file.	ALL
Default Scan Mode	If you wish to use this scan mode as the default scan mode when storing destinations, select the "Default Scan Mode" checkbox. The "Default Scan Mode" is also used for Scan to E-mail when the e-mail address is directly entered or selected from an LDAP server.	Not selected



- For normal text originals, a sufficiently legible image is produced when the color mode is set to "Mono 2 gradation" and the resolution is 200 dpi or 300 dpi. The 600 dpi setting should only be used in cases where high-clarity image reproduction is required, such as a photograph or an illustration. Note that a high resolution setting will result in a larger file size, and transmission may not be successful if there is insufficient disk capacity in the server to which the image is sent (or if the administrator of the server has restricted the file size). If transmission is not successful, you can try such measures as reducing the number of scanned pages in the file or reducing the scan size setting for the original.
- To open the scanned image without using the software program in the CD-ROM that accompanies the network expansion kit, the recipient must have a viewer program that can open the image format (file type) that was selected as explained above.
- The factory default setting for the image format produces the smallest file (File Type: TIFF, Compression Mode: MMR (G4)). If the recipient cannot open the image, try sending the image in a different format.
- If the number of scanned originals is not divisible by the number set in "Pages Per File", the last file will have less pages.
- The scan settings stored in a scan mode cannot be edited or deleted if the scan mode has been selected for a destination.

STORING DESTINATIONS

To store scanning destinations, click [Destination] in the Web page menu frame. This screen can also be used to edit or delete stored destinations. (p.12)

A total of 200 destinations* can be stored, including E-mail, FTP, Desktop, and Group destinations.

* Multiple e-mail addresses can be stored as a group (up to 100). Note that this may reduce the maximum number of destinations (normally 200) that can be stored.

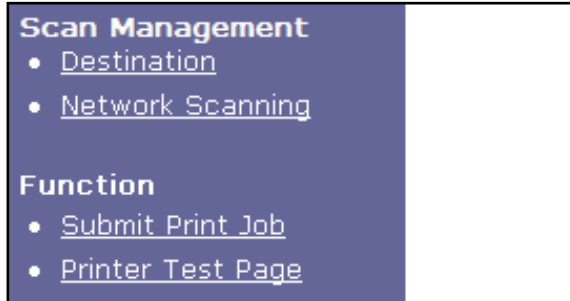

E-mail: See below
 FTP: See page 9.
 Desktop: See page 10.
 Group (E-mail): See page 11.

1

Storing destinations for Scan to E-mail

1 Click [Destination] in the menu frame of the Web page.



3 Enter the destination information.

For each setting, see the following table.

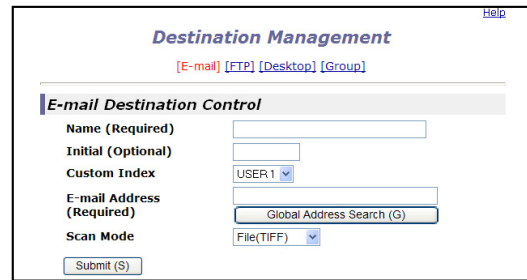

2 Click [E-mail].



4 When you have finished entering the information, click [Submit].

The entries will be stored.



To perform Scan to E-mail, the SMTP server settings must first be established. (p.15))

E-mail destination information

Item	Description
Name (Required)	Enter the name of the destination (up to 36 characters).
Initial (Optional)	Enter initial text for the destination (maximum of 10 characters). When the destination list is displayed in the destination control screen, the initial text is used to group the destinations.
Custom Index	Names can be assigned to the custom indexes as desired (p.6), allowing convenient grouping of destinations. Select a custom index for the destination to be stored.
E-mail Address (Required)	Enter the e-mail address of the destination (up to 64 characters). If an LDAP server is being used, you can click the [Global Address Search] button to search for an address on the LDAP server.
Scan Mode	Select the name of the scan mode that you wish to use for the destination. The scan mode must be previously stored (p.7).

Storing destinations for Scan to FTP

- 1** Click [Destination] in the menu frame of the Web page.



- 2** Click [FTP].



- 3** Enter the destination information.

For the settings, see the following table.

- 4** When you have completed all the entries, click [Submit].

The entries will be stored.



- If you select the "Enable Hyperlink to FTP server to be e-mailed" checkbox and select a previously stored recipient (p.8) from "E-mail Destination", an e-mail will be sent to the recipient informing them of the file format and location of the scanned image data (Scan to FTP (Hyperlink)). A hyperlink to the file server to which the scanned image data was sent appears in the e-mail, and the recipient can click the hyperlink to go directly to the location where the image data is stored.
- Use "Scan Mode" to select a set of previously stored scanning settings (see "STORING SCANNING SETTINGS" (p.7)). The list shows the names of the stored scan modes.

FTP destination information

Item	Description
Name (Required)	Enter the name of the destination (up to 36 characters).
Initial (Optional)	Enter initial text for the destination (maximum of 10 characters). When the destination list is displayed in the destination control screen, the initial text is used to group the destinations.
Custom Index	Names can be assigned to the custom indexes as desired (p.6), allowing convenient grouping of destinations. Select a custom index for the destination to be stored.
Hostname or IP Address (required)*1	Enter the IP address or host name of the FTP server (maximum of 127 characters).
User Name (Optional)	Enter the login user name for the FTP server (maximum of 32 characters).
Password (Optional)	Enter the login password for the FTP server (maximum of 32 characters).
Directory (Optional)	If you wish to specify a destination directory on the FTP server, enter the directory (maximum of 200 characters).
Enable Hyperlink to FTP server to be e-mailed (Checkbox)*2	When you send a scanned file to an FTP server, you can have a transmission notification automatically sent to the file recipient by e-mail. To have transmission notifications sent, select the checkbox. The FTP server name will appear in the transmission notification as a hyperlink.
E-mail Destination	Select the recipient that you wish to notify of the file transmission to the FTP server. To select a recipient here, the recipient's e-mail address must have been previously stored. (p.8)
Scan Mode	Select the name of the scan mode that you wish to use for the destination. The scan mode must be previously stored (p.7).

*1 If you entered a host name in "Hostname or IP Address", you will need to enter the DNS server settings. (p.15)

*2 To perform Scan to FTP (Hyperlink), you must also enter the settings for the e-mail server.

Storing destinations for Scan to Desktop

The destination for Scan to Desktop is stored by the Sharp Network Scanner Tool Setup Wizard when "Network Scanner Tool" is installed in your computer. For this reason, there is no need to store the Scan to Desktop destination in the Web page. (The Network Scanner Tool is on the "Sharpdesk" CD-ROM that accompanies the Network Expansion Kit.) For information on Scan to Desktop system requirements, installing the Network Scanner Tool, and storing the destination, see the "[SHARPDESK CD-ROM \(for Windows\)](#)" (p.25). Normally your computer is stored as the destination by the method indicated above.

The following page for storing Scan to Desktop destination information appears when [Destination] is selected in the menu frame, followed by [Desktop]. This page is used mainly by the system administrator in the following circumstance.

- When another machine that also has the network expansion kit is added to your network and you wish to send an image scanned on the new machine to a destination stored on the existing machine.

See "[Editing and deleting programmed transmission destinations](#)" (p.12) to select the Scan to Desktop destination information that you wish to use on the new machine and enter the displayed information in this screen in the new machine. (When you have completed all entries, click [Submit].)

If there are several destinations that you wish to use on the new machine, repeat this procedure as needed.

If the information entered here differs from the information entered on the host computer, transmission/reception will not be possible.

For the settings, see the following table.

Scan to Desktop destination information

Item	Description
Name (Required)	Enter the name of the destination (up to 36 characters).
Initial (Optional)	Enter initial text for the destination (maximum of 10 characters). When the destination list is displayed in the destination control screen, the initial text is used to group the destinations.
Custom Index	Names can be assigned to the custom indexes as desired (p.6), allowing convenient grouping of destinations. Select a custom index for the destination to be stored.
Hostname or IP Address (Required)*	Enter the IP address or host name of the FTP server (maximum of 127 characters).
Port Number (Required)	Enter a port number from 0 to 65535 for the desktop network scanner tool.
Process Directory (Optional)	Enter the destination directory name for the file (maximum of 200 characters). The file will be processed in this directory after it is received.
User Name (Optional)	Enter the login user name for the network scanner tool (maximum of 32 characters).
Password (Optional)	Enter the login password for the network scanner tool (maximum of 32 characters).
Scan Mode	Select the name of the scan mode that you wish to use for the destination. The scan mode must be previously stored (p.7).

* If you entered a host name in "Hostname or IP Address", you will need to enter the DNS server settings. ([p.15](#))

Storing Groups (Scan to E-mail)

You can send a scanned image to multiple e-mail destinations in a single Scan to E-mail operation. If you frequently transmit to a fixed group of destinations, you can store the destinations as a group.



Up to 100 destinations can be stored in one group.

1 Click [Destination] in the menu frame of the Web page.



2 Click [Group].



3 Enter the destination information.

For the settings, see the following table.

4 When you have completed all of the entries, click "Submit".

The entries will be stored.

Storing a group of destinations

Item	Description
Name (Required)	Enter the name of the destination (up to 36 characters).
Initial (Optional)	Enter initial text for the destinations (maximum of 10 characters). When the destination list is displayed in the destination control screen, the initial text is used to group the destinations.
Custom Index	Names can be assigned to the custom indexes as desired (p.6), allowing convenient grouping of destinations. Select a custom index for the destination to be stored.
Address(es) (Required)	Select the address of each destination from the "E-mail" list box. Programmed e-mail destinations appear in each of the destination lists. To select multiple destinations, click each address while holding down the [Ctrl] key on the keyboard. If you need to cancel an address that has been selected, click the address again while holding down the [Ctrl] key. If an LDAP server is being used, you can click the [Global Address Search] button to search for an address on the LDAP server. Multiple e-mail addresses can be entered. Separate the e-mail addresses with a comma (,), semi-colon (;), space (), or colon (:).
Scan Mode	Select the name of the scan mode that you wish to use for the destination. The scan mode must be previously stored (p.7).

Editing and deleting programmed transmission destinations

To edit or delete programmed destinations, click [Destination] in the menu frame of the Web page.

1 Click [Destination] in the menu frame of the Web page.



2 In the Destinations List, click the checkbox of the destination that you want to edit or delete.

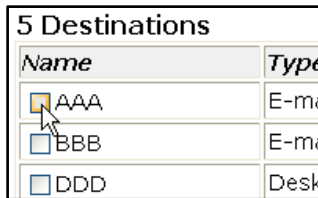

3 To edit the selected destination, click [Edit] at the bottom of the Destinations List.

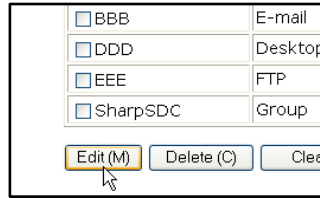

The programming screen of the destination selected in step 2 appears. Edit the information in the same way as you initially stored it.

When finished, be sure to click [Submit] to save your changes.

To delete the selected destination, click [Delete] at the bottom of the Destinations List.

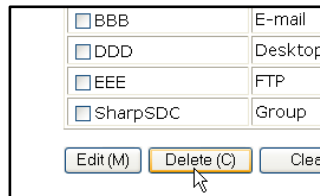

A message appears asking you to confirm the deletion. Click [Yes] to delete.



If you attempt to delete a programmed destination in the following situations, a warning message will appear and deletion will not be possible.

- The destination is included in a group.

If the destination is being used for a current transmission, cancel the transmission or wait until it is completed and then delete the destination. If the destination is included in a group, delete the destination from the group and then delete the destination.

Printing lists of programmed destinations

You can print lists showing the destinations that have been programmed.

The following lists can be printed.

- Print individual list: Shows the information programmed in e-mail, FTP, desktop, and group destinations.
- Print group list: Shows only the information programmed in group (e-mail) destinations.

1 Click [Destination] in the menu frame of the Web page.



2 To print the individual list, click [Print Individual List] at the bottom of the destinations list.

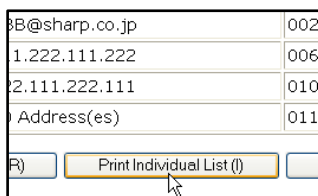

3 To print the group list, click [Print Group List] at the bottom of the destinations list.

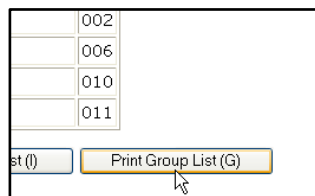

ABOUT THE WEB PAGE (FOR THE ADMINISTRATOR)

In addition to the menu that appear in the user Web page, the Web page for the administrator also shows menus that can only be established by the administrator.

A menu frame appears on the left side of the page. When you click an item in the menu, a screen appears in the right frame that allows you to configure settings for that item.

Settings that can only be configured by the administrator are explained here.

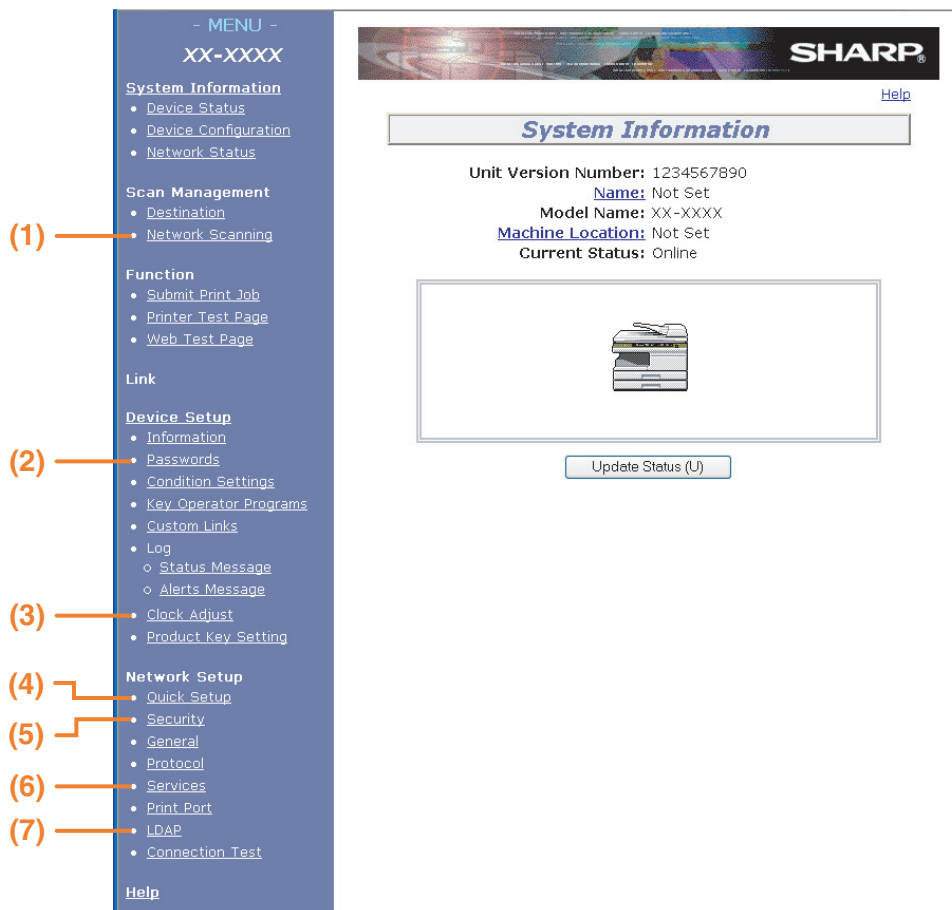

1

(1) Network Scanning (p.14)

This lets you select transmission methods for the network scanner function and configure settings for Scan to E-mail.

(2) Passwords (p.16)

The administrator can establish passwords to protect the Web site. Enter the password that you wish to establish and click the [Submit] button.

A password can be set for the administrator and users.

(3) Clock Adjust

This is used to set the time in the machine. Make sure the time is set correctly when performing Scan to E-mail.

This setting does not appear on models that have the fax function. If your model has the fax function, see the "Operation manual (for facsimile)" to set the time at the operation panel of the machine.

(4) Quick Setup (p.15)

This is used to configure basic settings for the SMTP, DNS, and LDAP servers.

(5) Security

Port numbers can be changed or disabled for security purposes.



If "HTTP" is disabled, it will not be possible to open the Web page. To open the Web page in this case, the network expansion kit must be reset.

☛ ["HOW TO RESET THE NETWORK EXPANSION KIT"](#) (p.24)

(6) Services (p.15)

This is used to configure advanced SMTP and DNS server settings as needed for each transmission method.

(7) LDAP (p.15)

This is used to configure advanced settings for global address searches.

BASIC SETTINGS FOR NETWORK SCANNING

Click [Network Scanning] in the menu frame and configure the required settings. A password is required to access this screen. (p.16) These settings should only be configured by the network administrator. For explanations of each of the items, click [Help] in the menu frame.

1 Click [Network Scanning] in the menu frame.



The Network Scanning setup page appears.

2 Select the transmission methods that you wish to use.

Select the scanner delivery methods that you want to use. In the "Enable Scanner Delivery to:" field, click the checkbox next to each method that you want to use so that a checkmark appears in the checkbox.

All transmission methods are initially selected (factory default settings).

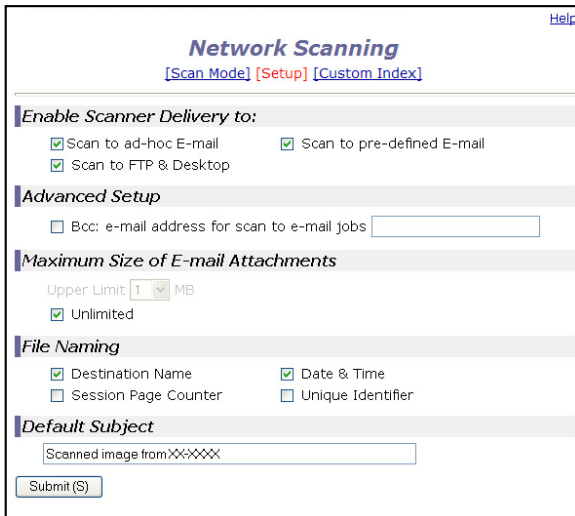

3 Configure the Advanced Setup settings.

Select advanced functions that can be used for Scan to E-mail.

If you wish to BCC a copy of a Scan to E-mail transmission to an e-mail address, select the [Bcc] checkbox and enter the e-mail address.

4 Set a limit for the size of image files.

To prevent the transmission of excessively large files by Scan to E-mail, you can set a size limit. If the image file created from the scanned image is larger than the set limit, the image file is discarded. The limit can be set from 1 MB to 10 MB in increments of 1 MB.

The factory default setting is [Unlimited]. If you wish to set a limit, remove the checkmark from the [Unlimited] checkbox and enter the desired limit.

5 Select the method for assigning a file name to a scanned image.

Select the method for assigning a file name to a scanned image. In "File Naming", click the items that you wish to use in the file name. "Destination Name" and "Date & Time" are initially selected.



If you are going to send images to the same recipient more than once, we recommend that you also select "Session Page Counter" or "Unique Identifier" to prevent sending multiple files with the same name, which would result in each successive file overwriting the previous file.

6 Selecting an e-mail subject (only used for Scan to E-mail).

The setting is used to enter the subject that appears in the recipient's e-mail program when you perform Scan to E-mail. (This setting is not necessary if you will not be using Scan to E-mail.) Enter a subject (maximum of 80 characters). If nothing is entered, "Scanned image from <Device Name>*" will appear.

* The name that appears in Device Name is the name stored in "Name" in the screen that appears when you click [System Information] in the menu frame. If a name has not been stored, the product name will appear.

7 Click [Submit].

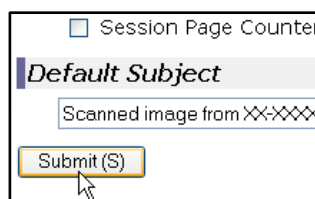

After entering the settings, be sure to click [Submit] to store them.

VARIOUS SERVER SETTINGS

The procedures for using [Quick Setup] are explained here. [Quick Setup] is used to quickly configure only the required settings for "SMTP", "DNS", and "LDAP" servers. These settings are normally configured first.

SMTP server: SMTP is used to transmit e-mail that is sent using Scan to E-mail or Scan to FTP (Hyperlink). To use these transmission methods, your SMTP server settings must be configured.

DNS server: If you entered a host name in "Primary SMTP Server" or "Secondary SMTP Server" of "SMTP", you must also configure your DNS server settings.

You will also need to configure your DNS server settings if host names will be entered in "Hostname or IP Address" when storing destinations for Scan to FTP (Scan to FTP (Hyperlink)) or Scan to Desktop.

LDAP server: If mail addresses are managed on your network by an LDAP server, the e-mail addresses stored in the LDAP server can be used for Scan to E-mail.

To allow the machine to use the e-mail addresses in the LDAP server, the LDAP server settings must be configured in the Web page.

Configuring SMTP, DNS and LDAP server settings.

1

1 Click [Quick Setup] in the menu frame.



3 When you have completed all of the entries, click [Submit].

The entries will be stored.

2 Enter the required information in "SMTP", "DNS" and "LDAP".

For explanations of each setting, click [Help] in the upper right-hand corner of the window.



If you need to configure advanced settings for the SMTP, DNS, and LDAP servers, follow the procedures below.

- Configuring SMTP and DNS server settings
Click [Services] in the menu frame to display the services setup screen. Select the desired server and then configure the required parameters for that server.
- Configuring LDAP server settings
Click [LDAP] in the menu frame to display the LDAP setup screen. Configure the required parameters.

PROTECTING INFORMATION PROGRAMMED IN THE WEB PAGE ([Passwords])

The settings and information programmed in the Web page can be protected by establishing passwords (click [Passwords] in the menu frame). The administrator must change the factory default password to a new password. The administrator should also take care to remember the new password. From now on, the new password must be entered each time you wish to configure settings in the Web pages. A password can be set for the administrator and users.

1 Click [Passwords] in the menu frame.



2 Enter the current password in "Admin Password".

When establishing a password for the first time, enter "Sharp" in "Admin Password".



Be sure to enter "S" in upper case and "harp" in lower case (passwords are case sensitive).

3 Enter passwords in "User Password" and "Admin Password".

- A maximum of 7 characters and/or numbers can be entered for each password (passwords are case sensitive).
- Be sure to enter the same password in "Confirm Password" as you did in "New Password".

4 When you have completed all entries, click [Submit].

The entered password is stored.

After setting the password, turn the machine power off and then back on.

When prompted to enter the password, a user should enter "user" in "User Name" and an administrator should enter "admin" in "User Name". The appropriate password should be entered in "Password". For more information, click [Help] in the upper right-hand corner of the window.

2

USING THE NETWORK SCANNER FUNCTION

This section explains the procedure for scanning from the machine after the network scanner settings have been configured in the Web page.

For the operation panel and the parts of the machine that are used for network scanning, see the operation manual for the machine.

BASIC TRANSMISSION PROCEDURE

- 1 Press the [MODE SELECT] key to select scanner mode.

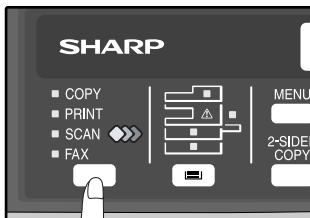

The "SCAN" indicator lights up to indicate that scanner mode is selected.

- 2 Place the original in the document feeder tray or on the document glass.

For information on how to place the original, see "[IMAGE ORIENTATION AND STANDARD ORIGINAL LOADING ORIENTATION](#)" (p.20).

- 3 Press the [◀] key (▽) or [▶] key (△) to select "ADDRESS SEARCH" and then press the [ENTER] key.

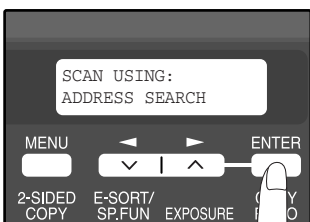

The selections change as follows each time the [▶] key (△) is pressed: "INPUT ADDRESS" → "GLOBAL ADDRESS" → "ADDRESS SEARCH". If you continue to press the [▶] key (△), the stored destinations will appear in alphabetical order based on the initial stored for each destination.

- 4 Enter search characters and press the [ENTER] key.

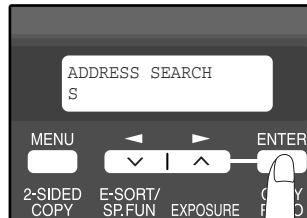

You will search the names that were entered for the destinations. Destinations matching the search characters will appear.

To enter characters, see "[HOW TO ENTER CHARACTERS](#)" (p.20).

- 5 Press the [◀] key (▽) or [▶] key (△) to select the destination and then press the [ENTER] key.

- 6 Press the [◀] key (▽) or [▶] key (△) to select the original size and then press the [ENTER] key.

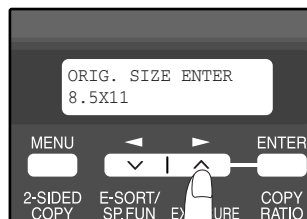

The original size changes as follows each time the [◀] key (▽) or [▶] key (△) is pressed: "8.5x11" → "8.5x5.5" → "A4" → "B5" → "A5" → "8.5x14" → "8.5x13".

- 7 Press the [START] key (⊙) to begin scanning.



- The [CLEAR] key (⊞) can be pressed during a scanning operation to return to the previous step of the operation. To cancel a scanning operation and return to the initial state of scanner mode, press the [CLEAR ALL] key (⊞).
- The network scanner function cannot scan both sides of an original placed in the RSPF.
- The scan settings stored in a scan mode cannot be edited if the scan mode has been selected for a destination. You can either store the desired settings in a new scan mode as explained in "[STORING SCANNING SETTINGS](#)" (p.7) and then edit the destination settings, or you can cancel the selection of the scan mode for the destination and then edit the scan mode settings.



- Before performing Scan to E-mail, read "[IMPORTANT POINTS WHEN USING SCAN TO E-MAIL](#)" (p.23). Take care that the image file is not too large.
- A limit for the size of image files that can be sent using Scan to E-mail can be set in "Maximum Size of E-mail Attachments" ([p.14](#)) of the Web page.

TRANSMISSION METHODS FOR SCAN TO E-MAIL

The e-mail address for a Scan to E-mail transmission can be entered manually or selected from e-mail addresses stored on an LDAP server.

Sending an image by entering an e-mail address manually

1 Press the [MODE SELECT] key to select scanner mode.

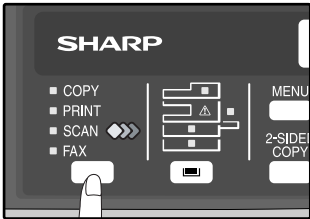

The "SCAN" indicator lights up to indicate that scanner mode is selected.

2 Place the original in the document feeder tray or on the document glass.

For information on how to place the original, see "[IMAGE ORIENTATION AND STANDARD ORIGINAL LOADING ORIENTATION](#)" (p.20).

3 Select "INPUT ADDRESS" and press the [ENTER] key.

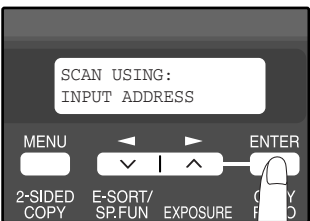

If "INPUT ADDRESS" does not appear, make sure that "Scan to ad-hoc E-mail" is enabled in the Web page ([p.14](#)).

4 Enter the destination e-mail address and press the [ENTER] key.

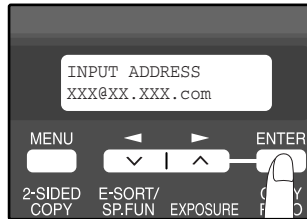

To enter characters, see "[HOW TO ENTER CHARACTERS](#)" (p.20).

5 Press the [◀] key (▽) or [▶] key (△) to select the original size and then press the [ENTER] key.

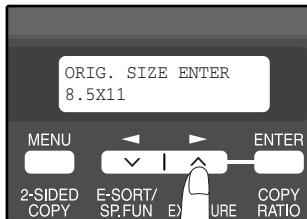

The original size changes as follows each time the [◀] key (▽) or [▶] key (△) is pressed:
 "8.5x11" → "8.5x5.5"
 → "A4" → "B5" → "A5"
 → "8.5x14" → "8.5x13".

6 Press the [START] key (⊙) to begin scanning.



The original is scanned using the settings of the scan mode that has the "Default Scan Mode" checkbox selected.

Sending an image by selecting an e-mail address in an LDAP server

To use an LDAP server, the LDAP server settings must be configured in the Web page.

- 1 Press the [MODE SELECT] key to select scanner mode.

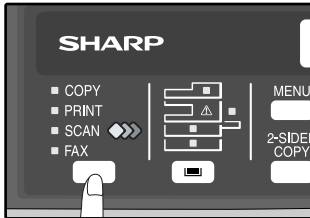

The "SCAN" indicator lights up to indicate that scanner mode is selected.

- 2 Place the original in the document feeder tray or on the document glass.

For information on how to place the original, see "[IMAGE ORIENTATION AND STANDARD ORIGINAL LOADING ORIENTATION](#)" (p.20).

- 3 Press the [◀] key (▽) or [▶] key (△) to select "GLOBAL ADDRESS" and then press the [ENTER] key.

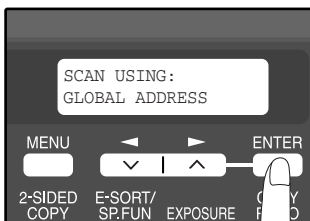

- 4 Enter search characters and press the [ENTER] key.



Destinations matching the search characters will appear.

To enter characters, see "[HOW TO ENTER CHARACTERS](#)" (p.20).



If you do not know the exact name, you can enter "*" for characters that you do not know to conduct a wildcard search.

- 5 Press the [◀] key (▽) or [▶] key (△) to select the destination and then press the [ENTER] key.

- 6 Press the [◀] key (▽) or [▶] key (△) to select the original size, and then press the [ENTER] key.

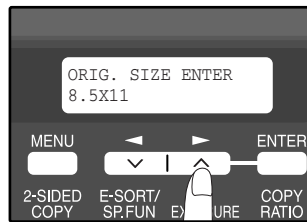

The original size changes as follows each time the [◀] key (▽) or [▶] key (△) is pressed:
 "8.5x11" → "8.5x5.5"
 → "A4" → "B5" → "A5"
 → "8.5x14" → "8.5x13".

- 7 Press the [START] key (⊙) to begin scanning.



The original is scanned using the settings of the scan mode that has the "Default Scan Mode" checkbox selected.

IMAGE ORIENTATION AND STANDARD ORIGINAL LOADING ORIENTATION

When using the document glass, the original should be placed face down. Center the original vertically on the document glass with the top edge at the left edge of the glass.
 When using the RSPF, the original should be placed face up in the middle of the document feeder tray, with the top of the original to the right. (The network scanner function cannot scan both sides of an original placed in the RSPF.)

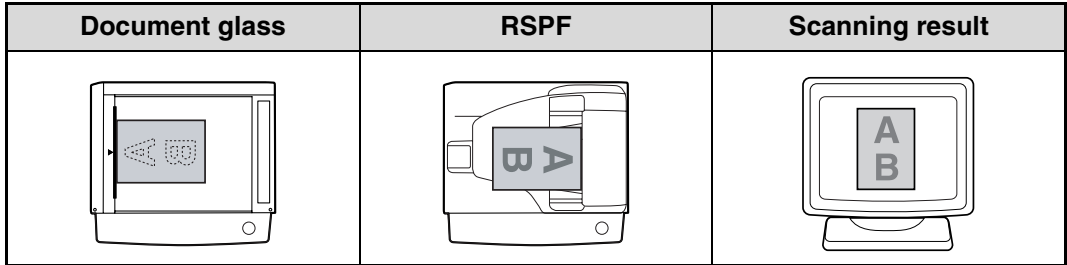

Long horizontal originals (from 8-1/2" to 14") can only be placed as shown below. For this reason, the scanned image will be rotated 90° when viewed on a computer.

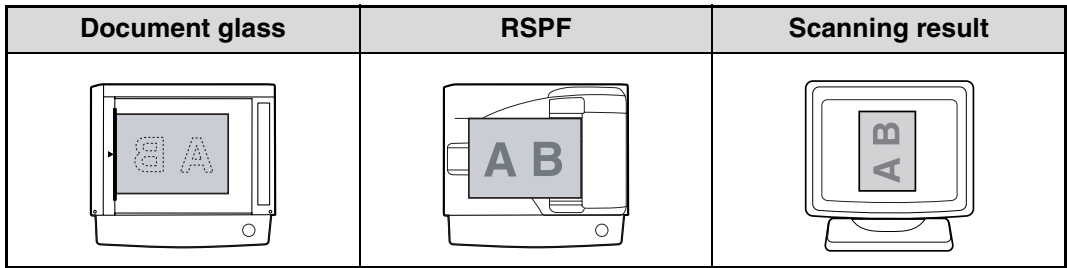

2

HOW TO ENTER CHARACTERS

You can enter letters with the numeric keys. Letters are marked above each of numeric keys [2] through [9]. To enter a letter, press the appropriate key repeatedly until the desired letter appears (the number of the key appears first, followed by letters in the order marked above the key). The keys used for entering characters are shown below.

The following characters can be entered with the numeric keys:

	ABC	DEF
1	2	3
GHI	JKL	MNO
4	5	6
PQRS	TUV	WXYZ
7	8	9
		@.-_
*	0	#

Characters that can be entered		
key	When entering e-mail address	When entering search characters
1	1	1 Space
2	a b c 2 A B C	A B C 2 a b c
3	d e f 3 D E F	D E F 3 d e f
4	g h i 4 G H I	G H I 4 g h i
5	j k l 5 J K L	J K L 5 j k l
6	m n o 6 M N O	M N O 6 m n o
7	p q r s 7 P Q R S	P Q R S 7 p q r s
8	t u v 8 T U V	T U V 8 t u v
9	w x y z 9 W X Y Z	W X Y Z 9 w x y z
*	_ . @	*} {[?>=;:,+)'(&%\$!/_- .@#
0	0	0
#	@.-_	#@.-_ /! "\$%&'() +,;:=>?[]{}*

- To enter two characters in succession which require using the same key, press the [▶] key (◁) once after entering the first character and then enter the second character.
- If you enter an incorrect character or number, follow these steps to correct the mistake.
 1. Press the [◀] key (◁) or [▶] key (▷) to move the cursor to the character immediately following the incorrect character.
 2. Press the [CLEAR] key (⊞).
 - The character in front of the cursor is deleted.
 3. Enter the correct character.
 - The character is inserted in front of the cursor.

TROUBLESHOOTING

If a problem or question arises, try to solve the situation using the following information before contacting your authorized SHARP dealer.

Image transmission problems are explained here. For image scanning problems, see the operation manual for the machine.

Problem	Cause and solution
The scanned image is clipped.	<p>The selected "Scan Size" setting is smaller than the actual original size.</p> <p>→ Set the scan size to the actual original size (p.17) and make sure that the original is placed in the correct orientation (p.20).</p> <p>If you intentionally selected a size setting smaller than the actual original size, take into consideration the part of the original that you wish to scan when placing the original. For example, if the actual size is 8-1/2" x 11" and you selected 5-1/2" x 8-1/2" for the size setting, place the original so that the part that you wish to scan is within the 5-1/2" x 8-1/2" area at the left, center of the glass.</p>
The received image data cannot be opened.	<p>The viewer program used by the recipient does not support the format of the received image data.</p> <p>→ Try selecting a different file type (TIFF / PDF / JPEG) and/or a different compression format (None, MH (G3), MMR (G4)) when sending the image data.</p> <p>Otherwise, have the recipient use Sharpdesk or a viewer program that supports the above combinations of file types and compression formats.</p>
When the same file name is used for two successive Scan to FTP transmissions, the second file is not sent.	The first file may still remain in the cache of the file server client. Disable use of the cache in the client software.
The recipient does not receive transmitted data.	<p>There is a mistake in the stored destination information or the wrong destination was selected.</p> <p>→ Make sure that the correct destination information is stored. If there is a mistake, correct it (p.12).</p> <p>* If delivery by e-mail (Scan to E-mail) is unsuccessful, an error message such as "Undelivered Message" may be sent to the designated administrator's e-mail address. This information may help you determine the cause of the problem.</p>
The recipient does not receive data sent by e-mail (Scan to E-mail).	<p>Check the Web page to see if a limit has been set for the size of image files sent using Scan to E-mail (the factory default setting is "Unlimited"). A limit can be set from 1 MB to 10 MB. Consult the administrator of the Web page to select a suitable limit (p.14).</p> <p>The amount of data that can be sent in one e-mail transmission is sometimes limited by the administrator of the mail server. Even if the amount of data sent is within the limit setting explained above, if it exceeds the limit set by the administrator of the mail server, the data will not be delivered to the recipient.</p> <p>Decrease the amount of data sent in the e-mail transmission (reduce the number of pages scanned). (Ask your mail server administrator what the data limit is for one e-mail transmission.)</p>
Transmission takes a long time.	When there is a large amount of image information, the data file is also large and transmission takes a long time.



Pay attention to the following points when selecting scan settings to ensure that an image file is created that suits the purpose of transmission in terms of image quality and file size. Scan settings are configured in the Web page.

- **Color mode**

Select a color mode that is appropriate for the use of the document to be scanned so that the file size will not be larger than necessary.

Scanning a document with the color mode set to gray scale or black and white will yield a smaller file size than scanning in color.

- **Resolution**

For normal text originals, a sufficiently legible image is produced when the color mode is set to "Mono 2 gradation" and the resolution is 200 dpi or 300 dpi.

The 600 dpi setting should only be used in cases where high-clarity image reproduction is required, such as an original that includes photographs or illustrations. Note that a high-resolution setting will result in a larger file size and transmission may not be successful if there is insufficient disk capacity in the server to which the image is sent (or if the administrator of the server has restricted the file size). If transmission is not successful, you can try such measures as reducing the number of scanned pages in the file or reducing the scan size setting for the original.

DISPLAY MESSAGES

If a transmission error occurs when you send a scanned image, a message informing you of the error and an error code will appear in the operation panel on the machine.

Error Code	Solution	Page
CE-00 CE-01	Turn off the power and turn it back on. Consult with your network administrator to make sure that no problems exist on the network or in the server. If the error is not cleared after turning the power off and on, turn off the power and contact your dealer.	—
CE-02 CE-04	Server access denied. The scanned image was not sent because a connection to the server could not be established. Make sure that the SMTP server settings or FTP server settings in the Web page are correct. The procedure for configuring the SMTP server is explained in " VARIOUS SERVER SETTINGS ", and the procedure for editing Scan to FTP destination information is explained in " Editing and deleting programmed transmission destinations ".	12, 15
CE-03	The scanned image was not sent because the server was busy or there was too much traffic. Wait briefly and then try again.	—
CE-05	The scanned image was not sent because the directory of the destination FTP server was not correct. Make sure that the correct FTP server information is configured in the Web page.	12
CE-09	The size of the scanned image file exceeds the upper limit set in "Maximum Size of File" in the Web page. Reduce the number of original pages scanned into the file, or change the upper limit set in "Maximum Size of File".	14
CE-12	The maximum number of destinations that can be searched has been exceeded. Increase the number of search characters to narrow the range of the LDAP search.	19
MEMORY FULL	The memory became full during scanning. Scan less pages, lower the resolution, or change the color mode so that the file size is smaller, and try scanning again. For the scan mode settings, see " STORING SCANNING SETTINGS ". (See Help in the Web page for explanations of each of the settings.)	7

IF YOUR E-MAIL IS RETURNED

If a Scan to E-mail is not successfully transmitted, an e-mail informing you of this fact is sent to the return address configured in the SMTP server. If this happens, read the e-mail and determine the cause of the error, and then repeat the transmission.

IMPORTANT POINTS WHEN USING SCAN TO E-MAIL

Be very careful not to send image data files that are too large.

Your mail server's system administrator may have placed a limit on the amount of data that can be sent in one e-mail transmission. If this limit is exceeded, the e-mail will not be delivered to the recipient. Even if there is no limit and your e-mail is successfully delivered, a large data file may take a long time to be received and place a heavy burden on the recipient's network, depending on the recipient's network (Internet) connection environment.

If large image data files are repeatedly sent, the resulting burden on the network may slow down the speed of other, unrelated data transmissions and in some cases, may even cause the mail server or network to go down.

The images on the following page will produce the following file sizes when scanned as 8-1/2" x 11" size or A4 size originals:

Resolution	File size of text original A when scanned	File size of photo original B when scanned	
	Mono 2 gradation	Grayscale	Full Color
75 dpi	Approx. 10 KB	Approx. 125 KB	Approx. 140 KB
300 dpi	Approx. 34 KB	Approx. 1430 KB (Approx. 1.43 MB)	Approx. 1440 KB (Approx. 1.44 MB)

3

* All sizes are for image files created in TIFF MMR (G4) format.

If multiple images are scanned, the file size will be approximately (Size of each image as indicated above) x (Number of images scanned).

Although the actual limitation depends on your network environment, a general guideline for the maximum file size for Scan to E-mail is 2000 KB (2 MB). In cases where you need to send multiple documents, try such measures as lowering the resolution mode.

Original image samples

The original images shown below are samples to help you understand the above explanations. Note that these images are smaller than the actual originals (the actual originals are 8-1/2" x 11" size).

Text original A

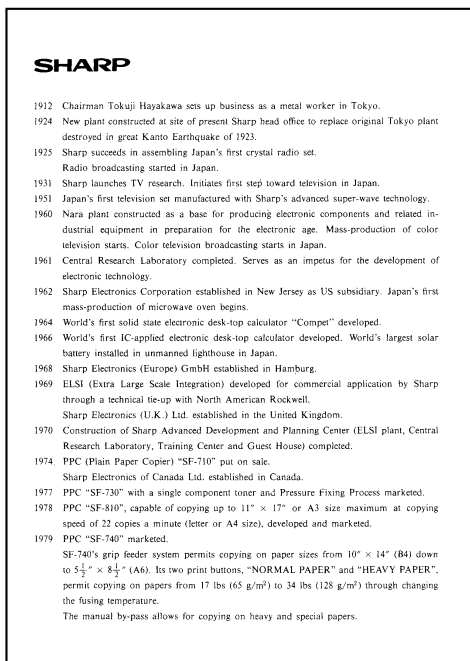
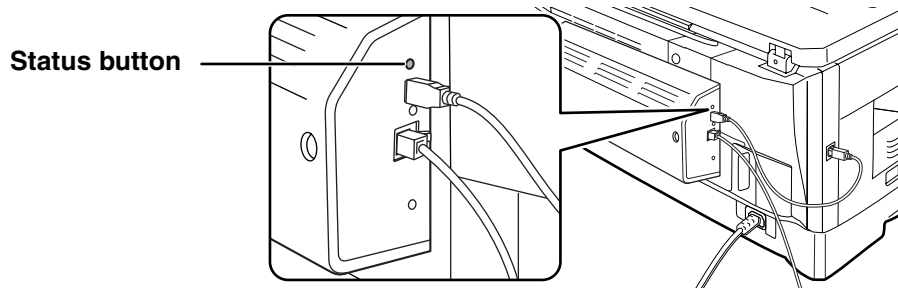

Photo original B



CHECKING THE IP ADDRESS

To check the IP address of the machine, hold down the status button on the network expansion kit at least 2 seconds to print out a Printer Setting List.



3

HOW TO RESET THE NETWORK EXPANSION KIT

To reset the network expansion kit, power on the machine while holding down the status button on the network expansion kit.



Network scanner destination information and scanning settings will remain after the network expansion kit is reset, however, the network settings and network printer settings will revert to the factory default settings.

4

SHARPDESK CD-ROM (for Windows)

The CD-ROM contains the following software programs:

- **Sharpdesk* (Desktop Document Management Software)**
- **Network Scanner Tool**
- **SHARP TWAIN AR/DM (Twain driver)**

* Sharpdesk can only be installed on the number of computers indicated in "Sharpdesk Serial Numbers" on the cover of "Important Information". If you need to install Sharpdesk on additional computers, please purchase the optional license kit.

(If the version of the software on the CD-ROM in the license kit is different from the version of the software on the CD-ROM that accompanies the machine, it is recommended that you use the newest version of the software.)

SOFTWARE PROGRAMS

4

For detailed information on each of the software programs, please refer to the user's guides on the CD-ROM. To view the manuals in PDF format, Acrobat Reader or Adobe Reader of Adobe Systems Incorporated is required. If neither program is installed on your computer, the programs can be downloaded from the following URL:

<http://www.adobe.com/>

SHARPDESK (Desktop Document Management Software)

Sharpdesk lets you manage a variety of electronic information such as scanned image data from a Digital Laser Copier/Printer or documents created using word processing or spreadsheet application software. Some of the important features of Sharpdesk are:

- Sharpdesk works with your scanner to let you read paper documents into your computer using a full-featured set of scanning controls and options.
- Sharpdesk makes editing of your images and documents quick and easy.
- A text image scanned into Sharpdesk can be converted into editable text for use with your favorite word processor. Sharpdesk uses an advanced Optical Character Recognition (OCR) engine that even preserves your document layouts.
- Distributing documents by e-mail or printing a hard copy is as easy as dragging a file onto an icon on the Sharpdesk OutputZone.
- Multiple files can be combined together into a single new file. After creating a combination file, the page order can be changed or new pages added.
- You can search for an image or text file using a single word, phrase, or list of words. You can also perform a detailed search by specifying the file type, modified data, or a keyword.
- A color image scanned on the machine can be saved as a PDF file using a high compression ratio to reduce the file size. (To view a PDF file saved using a high compression ratio, the latest version of Adobe Reader is required.)

NETWORK SCANNER TOOL

This is a utility that helps you use Scan to Desktop. It configures the necessary settings in the Digital Laser Copier/Printer and client computer to receive data. In addition, Network Scanner Tool will automatically start Sharpdesk upon receiving image data.

The scanned image received by your computer can automatically be:

- Saved in a folder.
- Passed to the application set in Network Scanner Tool.
- Sent as e-mail.
- Saved in Sharpdesk.

SHARP TWAIN AR/DM

SHARP TWAIN AR/DM imports image data from a Twain interface into a Twain-compliant application. SHARP TWAIN AR/DM has the following features:

- A selected range of the image data can be imported.
- The image can be rotated when imported.

USER'S GUIDES FOR SOFTWARE PROGRAMS

The Manual folder in the CD-ROM contains user's guides (in PDF format) for each of the software programs.

- **Sharpdesk Installation Guide**
- **Sharpdesk User's Guide**
- **Network Scanner Tool User's Guide**
- **SHARP TWAIN AR/DM User's Guide**

In addition to explaining how to use the programs, the user's guides also give detailed instructions for installing and setting up the programs. Be sure to read the user's guides before installing the programs.

INSTALLING THE SOFTWARE PROGRAM

Note the following when installing the software program from the CD-ROM:

- Be sure to check the system requirements for installation of each of the software programs in the user's guides and on the Information screen during installation.
- The user's guides give detailed instructions for installing and setting up the programs. Be sure to read the user's guides before installing the programs. In particular, if you are going to use Network Scanner Tool, be sure to carefully read the instructions regarding network preparation and setup procedures before installing the program. The network administrator should verify that network preparation has been carried out correctly.
- If you are going to send an original scanned with the Digital Laser Copier/Printer to a computer (Scan to Desktop), Network Scanner Tool must be installed.
- If you perform a standard installation of Sharpdesk (select "Typical" in the Setup Type selection screen), Network Scanner Tool will be also be installed, alternatively you can also select "Custom" installation and install only Network Scanner Tool.
- If Internet Explorer 6.0 or later is not installed on your computer, see the installation procedure for Internet Explorer in the Readme file (Readme.txt) in the root folder of the "Disc 2" CD-ROM.
- If you intend to install SHARP TWAIN AR/DM, install Network Scanner Tool first. SHARP TWAIN AR/DM cannot be installed alone.
- The contents of the Information screens that appear during installation can also be found in the ReadMe files on the same CD-ROM. The ReadMe file for Sharpdesk is located in the root folder of the CD-ROM, and the ReadMe file for SHARP TWAIN AR/DM is located in the Twain folder.

4

INSTALLING SHARPDESK AND NETWORK SCANNER TOOL

1 Quit any software applications and/or resident programs that are running on your computer.

2 Insert the "Disc 1" CD-ROM into your CD-ROM drive.

- The Sharpdesk installation screen appears. Proceed to step 6.
- If the screen does not appear, proceed to step 3.

3 Click the "start" button and then click "My Computer" ().

- In Windows 98/Me/2000, double click "My Computer".
- In Windows Vista, click the "Start" button and then click "Computer".

4 Double click the CD-ROM icon ().

The Sharpdesk installer starts.

5 Follow the instructions on the screen.

In Windows Vista, if a message screen appears asking you for confirmation, click "Allow".

6 When the "Customer Information" window appears, enter the serial number that appears on the cover of the this manual, and click the "Next" button.

Follow the instructions on the screen.

- If you select "Typical" in the Setup Type selection screen, Network Scanner Tool will also be installed. If you only wish to install Network Scanner Tool, select "Custom" in the Setup Type selection screen and then check only Network Scanner Tool.
- Sharpdesk Imaging* is installed together with Sharpdesk. If Imaging for Windows was previously installed, Sharpdesk Imaging will overwrite Imaging for Windows.
- If Eastman Software's "Imaging for Windows Professional Edition" has already been installed on your computer, Sharpdesk Imaging will not be installed.
- "Imaging for Windows Professional Edition" and Sharpdesk Imaging use common registry entries, and installing "Imaging for Windows Professional Edition" after Sharpdesk Imaging has been installed may result in abnormal operation. In this case, uninstall Sharpdesk and Sharpdesk Imaging, and then install "Imaging for Windows Professional Edition". After that, reinstall Sharpdesk.
- When Network Scanner Tool setup is finished, the "Search Setup Wizard" appears. Follow the on-screen instructions to create an index database. For detailed information, see the Sharpdesk Installation Guide and Sharpdesk User's Guide.
- * Sharpdesk Imaging is a version of Eastman Software's Imaging for Windows Professional Edition that has been customized by the Sharp Corporation.

INSTALLING SHARP TWAIN AR/DM

SHARP TWAIN AR/DM cannot be used in Windows Vista.

1 Quit any software applications and/or resident programs that are running on your computer.

2 Insert the "Disc 1" CD-ROM into your CD-ROM drive.

If the Sharpdesk installation window appears, click "Cancel" to exit the setup procedure.

3 Click the "start" button and then click "My Computer" ()

In Windows 98/Me/2000, double click "My Computer".

4 Click the CD-ROM icon () and select "Open" from the "File" menu.

5 Double-click the "Twain" folder, and then double-click the "SETUP" icon ()

6 Follow the instructions on the screen.

4

UNINSTALLING THE SOFTWARE PROGRAM

To remove the software, follow the steps below.

- When Sharpdesk is uninstalled, Network Scanner Tool is also uninstalled. Note that if Network Scanner Tool is uninstalled, you will no longer be able to directly receive image data from the Digital Laser Copier/Printer.
- If a user-created file is saved in the Sharpdesk desktop folder, the Sharpdesk desktop folder will not be deleted when Sharpdesk is uninstalled.
- If you uninstall Sharpdesk Imaging in Windows 98/Me/2000, you will not be able to open image files unless you re-install the Windows accessory Imaging for Windows.
- Removing SHARP TWAIN AR/DM will not delete the spooler folder which stores image data.

UNINSTALLING THE SOFTWARE PROGRAM FROM THE CONTROL PANEL

1 Click "Control Panel" in the "start" menu.

In Windows 98/Me/2000, click "Start", "Settings", and then "Control Panel".

2 Double click "Add or Remove Programs".

- In Windows 98/Me/2000, double click "Add/Remove Programs".
- In Windows Vista, click "Uninstall a program".

3 Select the application that you wish to delete ("Sharpdesk" or "SHARP TWAIN AR/DM") from the list and uninstall the software.

5

SPECIFICATIONS

For information on power requirements, power consumption, dimensions, weight, and other specifications that are common to all features of the machine, refer to the operation manual for the machine.

File format	File type: TIFF/PDF/JPEG Compression mode: MH (G3)/MMR (G4)/None
File creation method	One file for all pages/One file per each 1 to 6 pages
Scan destinations	Scan to FTP, Scan to Desktop, Scan to E-mail
Supported client PC operating systems (for Scan to Desktop function)	Windows 98, Windows Me, Windows 2000 Professional, Windows XP Home Edition, Windows XP Professional, Windows Vista
Web browser	Internet Explorer 5.5 or later (Windows), Netscape Navigator 6.0 or later
Management system	Uses built-in Web server
Network protocol	TCP/IP, SMTP, LDAP, FTP
Supported mail system	Mail servers supporting SMTP
LAN connectivity	10Base-T/100Base-TX Ethernet
Number of destinations	200 maximum
Number of destinations for Scan To E-mail broadcast transmission	100 maximum*

* Multiple e-mail addresses (up to 100) can be stored as a group. Note that this may reduce the maximum number of destinations (normally 200) that can be stored.

Some discrepancies may exist in the illustrations and content due to improvements to the machine.

SHARP[®]

SHARP CORPORATION

Network expansion kit Online Manual (for network printer)

Start

Click this "Start" button.

Introduction

The optional network expansion kit enables the machine to be used as a network printer.

This manual explains the network printer functions that can be used when the network expansion kit is installed.

To use the machine as a PS printer, the PS3 expansion kit (AR-PK1N) must be installed. After installing the expansion kit, the product key (password) must be entered in "Product Key Setting" in the Web page (this is only required once). Please consult your dealer for the product key to be entered.



- This manual refers to the digital multifunctional system AR-208S/208D as "the machine".
- For information on copier functions, adding paper and toner, removing misfeeds, using peripheral equipment, and other general information, see the operation manual for the machine. For information on the scanner functions that can be used when the network expansion kit is installed, see the online manual for network scanner that accompanies the network expansion kit.
- The machine's default settings and default settings for the printer function can be changed using the user programs. For more information, see the operation manual for the machine.
- Where "XX-XXXX" appears in this manual, please substitute the name of your model.
- This manual refers to the Reversing Single Pass Feeder as the "RSPF".
- The explanations of screens and procedures in this manual are primarily for Windows® XP in Windows® environments, and Mac OS X v10.4 in Macintosh environments. The screens may vary in other versions of the operating systems.
- For information on using your operating system, refer to your operating system's manual or online Help.
- The PS3 expansion kit (AR-PK1N) mentioned in this manual is an option.

Trademark Acknowledgments

- Microsoft®, Windows®, Windows® 98, Windows® Me, Windows® 2000, Windows® XP, Windows Server® 2003, Windows Vista® and Internet Explorer® are registered trademarks or trademarks of Microsoft Corporation in the U.S.A. and other countries.
- Macintosh is a trademark of Apple Inc., registered in the U.S. and other countries.
- Adobe, the Adobe logo, Acrobat, the Adobe PDF logo, and Reader are registered trademarks or trademarks of Adobe Systems Incorporated in the United States and other countries.
- PCL is a trademark of the Hewlett-Packard Company.
- PostScript is a registered trademark of Adobe Systems Incorporated.
- All other trademarks and copyrights are the property of their respective owners.

The display screens, messages, and key names shown in the manual may differ from those on the actual machine due to product improvements and modifications.



How to use the online manual

This section explains how to view the online manual. Please read this section before using the online manual. For information on using Acrobat Reader, see Acrobat Reader Help.

How to Control the Online Manual

In this manual, the following buttons are displayed at the bottom of each page. Click these buttons to move quickly to pages that you wish to view.



CONTENTS

Displays the Contents of this manual. Click on a topic in the Contents to jump directly to that section.



I N D E X

Displays the Index of this manual. Click on a topic in the Index to jump directly to that section.



Takes you forward page by page.



Takes you back page by page.

Following Links

This manual uses a link function that allows you to jump to a related page. If you click green, underlined text, the related page will be displayed. (In the Contents and Index sections, the linked areas are not underlined.)

Example: [Contents](#)

To return to the previous page, click the ← button on the menu bar of Acrobat Reader.

Using Bookmarks

Bookmarks have been created on the left side of this manual. You can click on a bookmark to jump directly to that section.

How to Print Out This Manual

To print this manual, select "Print" from the "File" menu of Acrobat Reader. Select the desired printer settings in the "Print" dialog box, and then click the "OK" button.



CONTENTS



I N D E X



3



Introduction	2
How to use the online manual	3

1 PRINTING FROM WINDOWS

Basic printing	6
• If the tray runs out of paper during printing	7
• Cancel a print job	7
• When "Paper Source" is set to "Auto Select"	7
Opening the printer driver from the "start" button	8
Printer driver settings	9
Two-sided printing	10
• Pamphlet style	11
Printing multiple pages on one page	12
Fitting the printed image to the paper	13
Rotating the print image 180 degrees	14
Printing a watermark	15
• How to Print a Watermark	15
Printing text and lines/graphics in black	16
• Printing text in black	16
• Printing lines and vector graphics in black	16

2 PRINTER UTILITIES (WINDOWS)

Printer utilities	17
• Before using the Printer Status Monitor	17
Using the printer utilities	18
• Starting up the printer utilities	18
• Using the printer utilities	18
• Changing the Printer Status Monitor settings	19
• Checking the printer status	20

3 PRINTING FROM MACINTOSH

Basic printing	21
• If the tray runs out of paper during printing	22
• Cancel a print job	22
• When "Paper Feed" is set to "Auto Select"	22



4 WEB FUNCTIONS IN THE MACHINE

About the Web pages	23
• How to access the Web page and view help	23
About the Web pages (for users)	24
Directly printing a file in a computer	25
• Advanced job settings	25
Configuring the printer condition settings	26
• How to configure the settings	27
• Printer condition setting menu	28
• Printer condition settings	29
About the Web pages (for the administrator)	32
Protecting information programmed in the web page ([Passwords])	33
E-mail print function	34
• Setting up the E-mail print function	34
• Using the E-mail print function	35
Key operator programs	36
• Configuring a setting in the key operator programs	36
• Key operator programs	37
E-mail status and e-mail alert settings	38
• Information setup	38
• SMTP setup	38
• Status message setup	39
• Alerts message setup	40

5 TROUBLESHOOTING

Troubleshooting	41
• Check the connections	41
Removing the software	42
• Windows	42
• Macintosh (Mac OS 9.0 to 9.2.2)	42

6 SPECIFICATIONS

Printer specifications	43
Printer driver specifications	44

7 INDEX



The following example explains how to print a document from WordPad.

Before printing, make sure that the correct size of paper for your document has been loaded in the machine.

1 Start WordPad and open the document that you wish to print.

2 Select "Print" from the application's "File" menu.

The "Print" dialog box will appear.

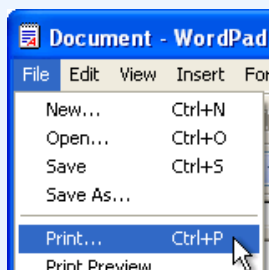

3 Make sure that "SHARP XX-XXXX" is selected as the printer. If you need to change any print settings, click the "Preferences" button ("Properties" button in Windows 98/Me) to open the printer driver setup screen.

The printer driver setup screen will appear.

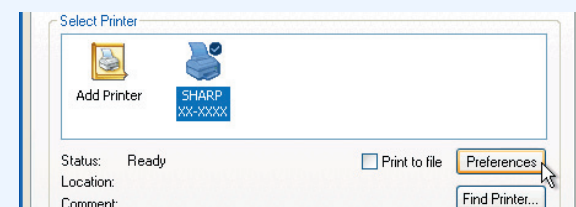

Windows 2000 does not have the "Preferences" button in this dialog box. Select settings as needed on each of the tabs in the setup screen.

☞ [Printer driver settings](#), [Two-sided printing](#), [Printing multiple pages on one page](#), [Fitting the printed image to the paper](#), [Rotating the print image 180 degrees](#), [Printing a watermark](#)

4 Click the "Print" button ("OK" button in Windows 98/Me).

Printing begins.

The print job is delivered to the output tray, with the position of the paper offset slightly from the previous job (offset function).

If the tray runs out of paper during printing

Printing will automatically resume when paper is loaded in the tray.

When using the bypass tray, select printer mode with the mode select key on the machine, load paper as instructed by the message in the display, and then press the [START] key to resume printing.

When the 250-sheet paper feed unit is installed:

Note that if the "AUTO TRAY SWITCH" setting in the user programs is enabled and there is the same size of paper in another tray, the machine will automatically switch to the other tray and continue printing.

Cancel a print job

To cancel a print job that is already in progress, select printer mode with the mode select key on the machine and then press the [CLEAR] key (C) or the [CLEAR ALL] key (CA).

"CANCEL PRINT JOB?" will appear in the display. Select "YES" and press the [ENTER] key.

When "Paper Source" is set to "Auto Select"

If "Paper Source" is set to "Auto Select" in the "Paper" tab of the printer driver setup screen and the correct size of paper for a print job is not loaded in the machine, the printing procedure will vary depending on the "FORCED OUTPUT" setting in the user programs (see "USER PROGRAMS" in the Operation Manual).

When "FORCED OUTPUT" is set to "OFF"

Select printer mode with the mode select key on the machine, check the message in the display, load paper in the bypass tray, and then press the [START] key to begin printing.

When "FORCED OUTPUT" is set to "ON"

Printing takes place on the paper loaded in the machine, even though the paper size is different from the print image size.

Opening the printer driver from the "start" button

Printer driver settings can be configured by opening the printer driver from the Windows "start" button. Settings adjusted in this way will be the initial settings when you print from an application. (If you change the settings in the printer driver setup screen at the time of printing, the settings will revert to the initial settings when you quit the application.)

Windows 2000/XP/Server 2003/Vista

1 Click the "start" button, and then click "Control Panel".

- On Windows 2000, click the "Start" button and select "Settings".
- On Windows Server 2003, click the "Start" button and then click "Printers and Faxes". Go to step 3.

2 Click "Printers and Other Hardware", and then click "Printers and Faxes".

- On Windows Vista, click "Printer".
- On Windows 2000, click "Printers".

3 Click the "SHARP XX-XXXX" printer driver icon and select "Properties" from the "File" menu.

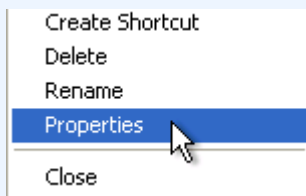

On Windows Vista, select "Properties" from the "Organize" menu.

4 Click the "Printing Preferences" button in the "General" tab.

The printer driver setup screen will appear.

👉 [Printer driver settings](#)

Windows 98/Me

1 Click the "Start" button, select "Settings" and then click "Printers".

2 Click the "SHARP XX-XXXX" printer driver icon and select "Properties" from the "File" menu.

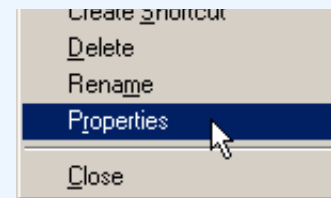

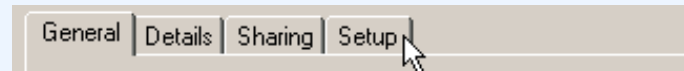

3 On Windows 98/Me, click the "Setup" tab.



The printer driver setup screen will appear.

👉 [Printer driver settings](#)

Printer driver settings

To view Help for a setting, click the  button in the upper right-hand corner of the window and then click the setting. Some restrictions exist on the combinations of settings that can be selected in the printer driver setup screen. When a restriction is in effect, an information icon () will appear next to the setting. Click the icon to view an explanation of the restriction.

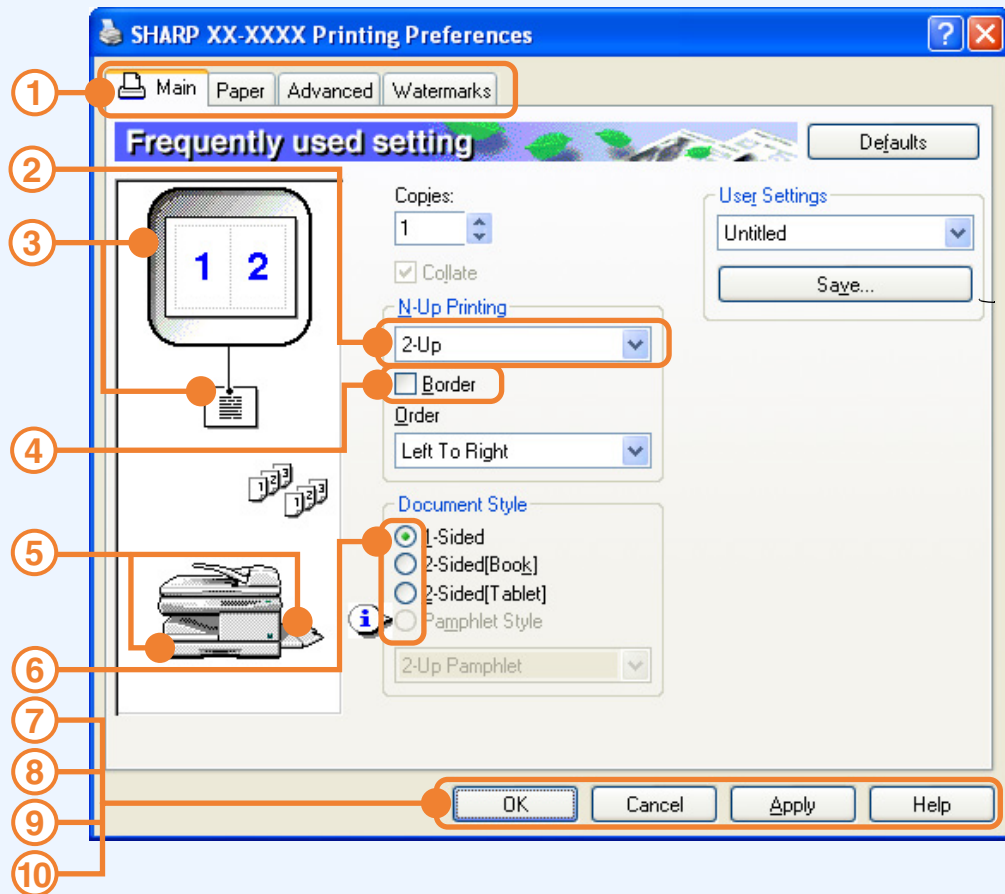

① Tab

The settings are grouped on tabs. Click on a tab to bring it to the front.

② Drop-down list

Allows you to make a selection from a list of choices.

③ Print setting image

This shows the effect of the selected print settings.

④ Checkbox

Click on a checkbox to activate or deactivate a function.

⑤ Machine image

The paper tray (in blue) selected in "Paper selection" on the "Paper" tab. You can also click on a tray to select it.

⑥ Check button

Allows you to select one item from a list of options.

⑦ "OK" button

Click this button to save your settings and exit the dialog box.

⑧ "Cancel" button

Click this button to exit the dialog box without making any changes to the settings.

⑨ "Apply" button

Click to save your settings without closing the dialog box.

⑩ "Help" button

Click this button to display the help file for the printer driver.



The settings and the image of the machine will vary depending on the model. The printer driver setup screen allows you to select various functions that can be used when the network expansion kit is installed. For information on the printer functions of the network expansion kit, see "[Printer driver specifications](#)".

The printer driver setup screen of models that support two-sided printing contains a "Document Style" setting in the "Main" tab. This feature allows you to print on both sides of the paper. To use this function, open the printer driver setup screen and select "2-Sided (Book)" or "2-Sided (Tablet)" from "Document Style" in the "Main" tab.

☞ See [Basic printing](#) for details on how to open the printer driver.

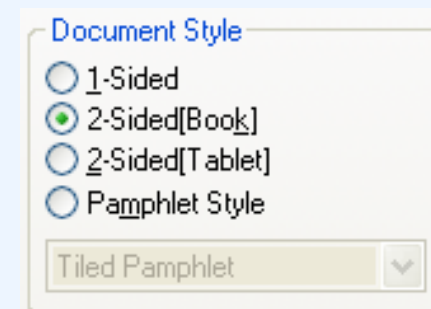

- Paper sizes that can be used for two-sided printing are Letter, Legal, Folio*, Invoice, A4, A5, B5, Foolscap, and 16K.
- When using two-sided printing, select a source other than "Bypass Tray" for the "Paper Source" in the "Paper" tab.
 - * For two-sided printing on Folio size paper, "Tray 1" or "Tray 2" (if Tray 2 has been installed) must be selected in the "Paper Source" on the "Paper" tab.

The following example shows the result when portrait data is printed on both sides of the paper.

Print data	Printing result	
	2-Sided (Book)	2-Sided (Tablet)
	<p>The pages are printed so that they can be bound at the side.</p>	<p>The pages are printed so that they can be bound at the top.</p>

Pamphlet style

Pamphlet style prints two pages each on the front and back of each sheet of paper (four pages total on one sheet) so that the sheets can be folded down the center and bound to create a pamphlet. This function is convenient when you wish to compile printed pages into a pamphlet.

To use this function, open the printer driver and select "Pamphlet Style" in "Document Style" in the "Main" tab.

The direction of opening of the pamphlet can be selected with the "Right Turning Pamphlet" checkbox in the "Advanced" tab. The following examples show how 8 pages are printed when pamphlet style is selected.

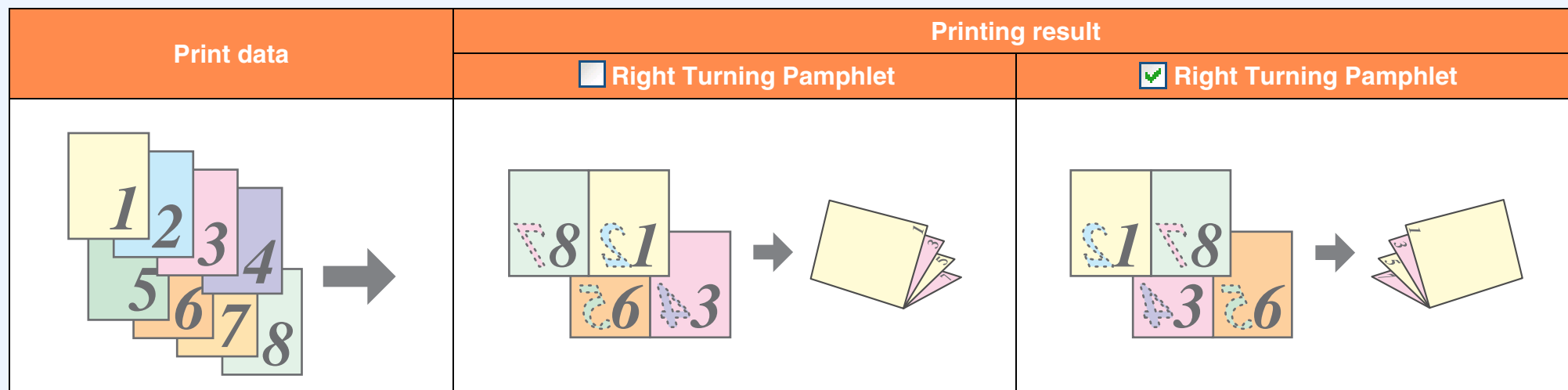
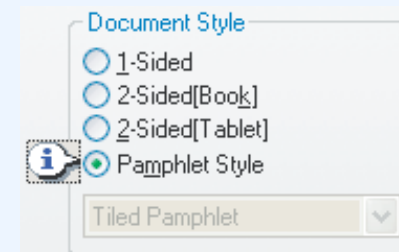

- Only letter, invoice, A4 and A5 size paper can be used for pamphlet style printing.
- Because four pages are printed on each sheet of paper, blank pages are automatically added at the end when the total number of pages is not a multiple of four.
- When "Tiled Pamphlet" is selected, printing will take place on paper that is twice the size of the paper size specified in the application.
- When "2-Up Pamphlet" is selected, each page is reduced in the same way as for 2-Up and printed on the size of paper that is specified in the application.

1

Printing multiple pages on one page

This feature allows you to reduce and print two, four, six, eight or sixteen document pages on a single sheet of paper. To use this function, open the printer driver setup screen and select the number of pages per sheet (2-Up, 4-Up, 6-Up, 8-Up, or 16-Up) in "N-Up Printing" in the "Main" tab.

The order of the pages can be changed in the "Order" menu.

See [Basic printing](#) for details on how to open the printer driver.



The "N-Up Printing" setting is not available when "Fit To Paper Size" is selected.

See [Fitting the printed image to the paper](#)

For example, when "2-Up" or "4-Up" is selected, the result will be as follows depending on the selected order.

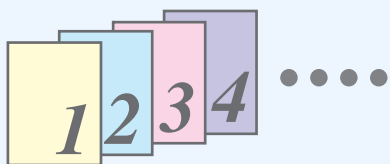
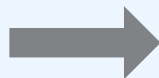
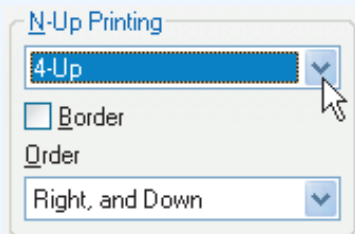

N-Up	Left to Right	Right to Left		
[2-Up]				
N-Up	Right , and Down	Down , and Right	Left , and Down	Down , and Left
[4-Up]				

If you select the "Border" checkbox, borderlines will be printed around each page.



Examples for 2-Up and 4-Up are shown here. The order of 6-Up, 8-Up, and 16-Up is the same as 4-Up. The order can be viewed in the print setting image in the printer driver setup screen.

See [Printer driver settings](#)

1

Fitting the printed image to the paper

The printer driver can adjust the size of the printed image to match the size of the paper loaded in the machine. Follow the steps shown below to use this function. The explanation below assumes that you intend to print a letter size document on invoice size paper.

☞ See [Basic printing](#) for details on how to open the printer driver.



The "Fit To Paper Size" setting is not available when "N-Up Printing" is selected.

☞ [Printing multiple pages on one page](#)

1 Click the "Paper" tab in the printer driver setup screen.

2 Select the original size (Letter) of the print image in "Paper Size".

3 Check the "Fit to Page" box.
When using the PS printer driver, select "Fit To Paper Size" in "Zoom Setting".

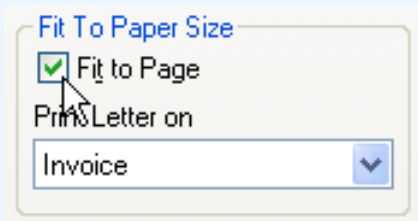

4 Select the actual size of paper to be used for printing (Invoice).

The size of the printed image will be automatically adjusted to match the paper loaded in the machine.

Paper Size: Letter
Fit To Paper Size: Invoice

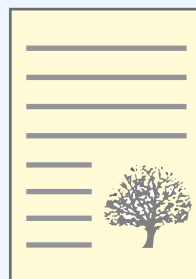

Letter size document
(Paper Size)

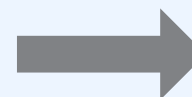

Invoice size paper
(Fit To Paper Size)



- If "A3 [Fit to Page]", "B4 [Fit to Page]", or "Ledger [Fit to Page]" is selected, the print image is fit to the letter size even if "Fit to Page" is not selected.
- When using the PS printer driver, the print image can be enlarged or reduced by means of numerical values. (The vertical and horizontal ratios can be set separately.) Select "XY-Zoom" in step 3, click the "Width/Length" button, and adjust the ratios in the screen that appears.



Rotating the print image 180 degrees

The print image can be rotated 180 degrees.

This feature is used to enable correct printing on envelopes and other paper with flaps that can only be loaded in one orientation.

To use the feature, select the image orientation in "Image Orientation" on the "Paper" tab, and then select the "Rotate 180 degrees" checkbox.

☞ See [Basic printing](#) for details on how to open the printer driver.

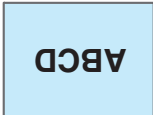
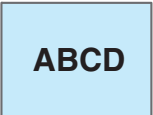

Printing result	
<input checked="" type="checkbox"/> Rotate 180 degrees	<input type="checkbox"/> Rotate 180 degrees
	



The procedure for loading paper is explained in the operation manual for the machine.

Printing a watermark

You can print a watermark such as "CONFIDENTIAL" on your document. To print a watermark, open the printer driver, click the "Watermarks" tab, and follow the steps below.

☞ See [Basic printing](#) for details on how to open the printer driver.

How to Print a Watermark

From the "Watermark" drop-down list, select the watermark that you wish to print (for example "CONFIDENTIAL"), and start printing.

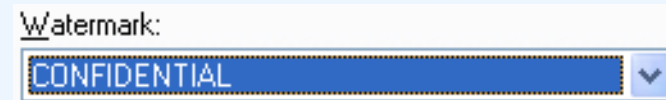
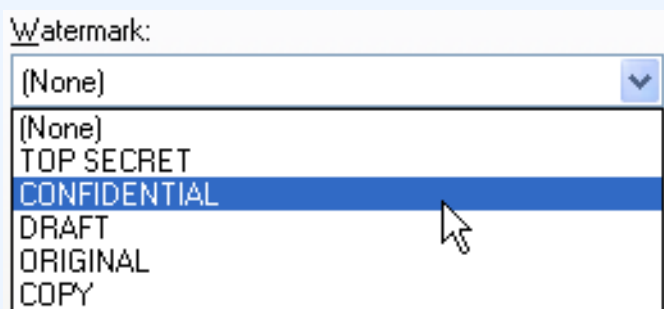

Print sample

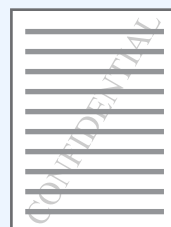
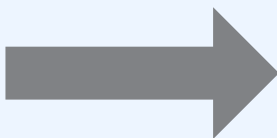

You can enter text to create your own custom watermark. For details on watermark settings, view printer driver Help.



☞ [Printer driver settings](#)

Printing text and lines/graphics in black

Color text, lines and vector graphics that are faint when printed normally can be printed in black to improve legibility.

Printing text in black

Text that is any color other than white is printed in black. To use this function, open the printer driver setup screen and select the "Text To Black" checkbox in the "Advanced" tab.

Print data	Printing result	
	<input type="checkbox"/> Text To Black	<input checked="" type="checkbox"/> Text To Black
		



- When using the PCL6 printer driver, if "Print as graphics" is selected in "TrueType Mode" of "Font" in the "Advanced" tab, this function cannot be used.
- When using the PCL5e printer driver, if "Raster" is selected in "Graphics mode" in the "Advanced" tab, this function cannot be used.

Printing lines and vector graphics in black

Lines and vector graphics that are any color other than white are printed in black.

To use this function, open the printer driver setup screen and select the "Vector To Black" checkbox in the "Advanced" tab.

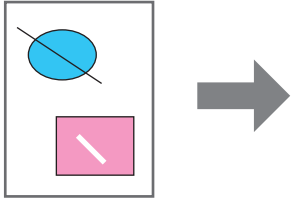
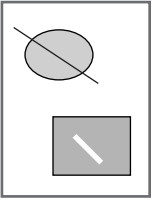
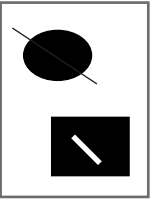
Print data	Printing result	
	<input type="checkbox"/> Vector To Black	<input checked="" type="checkbox"/> Vector To Black
		



When using the PCL6 or PCL5e printer driver, if "Raster" is selected in "Graphics mode" in the "Advanced" tab, this function cannot be used.

Printer Status Monitor (for general users)

"Printer Status Monitor" is on the "Software CD-ROM" (Disc 1). This allows the user to check on the computer screen whether or not the machine is able to print.

It provides information on error states such as paper misfeeds and shows the configuration of the machine (number of trays, etc.) by means of illustrations. Available paper sizes and paper remaining are also indicated.

Printer Administration Utility (for administrators)

"Printer Administration Utility" is on the "Software CD-ROM" (Disc 2).

This allows the administrator to check information on supplies and error states of the machine and other SHARP printers (compatible with the Printer Administration Utility) that are connected to the network. Settings can also be changed via the utility.



- In order to use the Printer Status Monitor and Printer Administration Utility, the machine must be connected to a network.
- To install the Printer Status Monitor, see the network expansion kit online manual (for setup).

Before using the Printer Status Monitor

Note the following points before using the Printer Status Monitor.

Printing via a server

When the first print job is executed after starting up the Printer Status Monitor, the machine's IP address is automatically set in the Printer Status Monitor.

Direct printing without a server

Install and configure the software as explained in "INSTALLING THE PRINTER DRIVER" in the software setup guide for network printer. (This is not necessary if the software has already been installed and configured.)

Starting up the printer utilities

If the Printer Status Monitor or Printer Administration Utility is not running, use the following procedure to start the utilities.



When the Printer Administration Utility is first started up, the TCP/IP settings window appears. To monitor the machine on a local network, select the "Local Subnet Search" checkbox. Otherwise, enter the machine's IP address. For more information, see the Help file.

Printer Status Monitor

Click the "Start" button, point to "All Programs" ("Programs" in operating systems other than Windows XP/Server 2003/Vista) and then "SHARP Printer Status Monitor". Select "Printer Status Monitor".

Printer Administration Utility

Click the "Start" button, point to "All Programs" ("Programs" in operating systems other than Windows XP/Server 2003/Vista) and then "SHARP Printer Administration Utility". Select "Printer Administration Utility".

Using the printer utilities

For information on using the Printer Status Monitor and Printer Administration Utility, see the Help files for each. The Help files can be viewed as follows:

Printer Status Monitor

Click the "Start" button, point to "All Programs" ("Programs" in operating systems other than Windows XP/Server 2003/Vista) and then "SHARP Printer Status Monitor". Select "Help".

Printer Administration Utility

Click the "Start" button, point to "All Programs" ("Programs" in operating systems other than Windows XP/Server 2003/Vista) and then "SHARP Printer Administration Utility". Select "Help".

Changing the Printer Status Monitor settings

Once installed, the Printer Status Monitor normally runs in the background in Windows. If you need to change the Printer Status Monitor settings, follow the steps below.

- 1 Right-click the Printer Status Monitor icon () on the task bar, and select "Preferences" from the pop-up menu.**

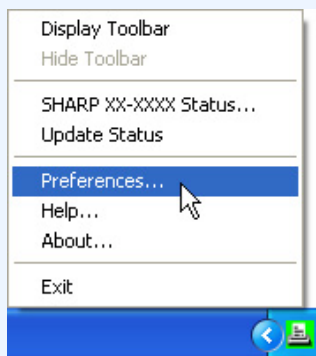

If the Printer Status Monitor icon does not appear on the task bar, see "[Starting up the printer utilities](#)" to start the Printer Status Monitor.

- 2 Change the Printer Status Monitor settings as desired.** For information on the Printer Status Monitor settings, see Printer Status Monitor Help. (Click the "Help" button in the settings window.)

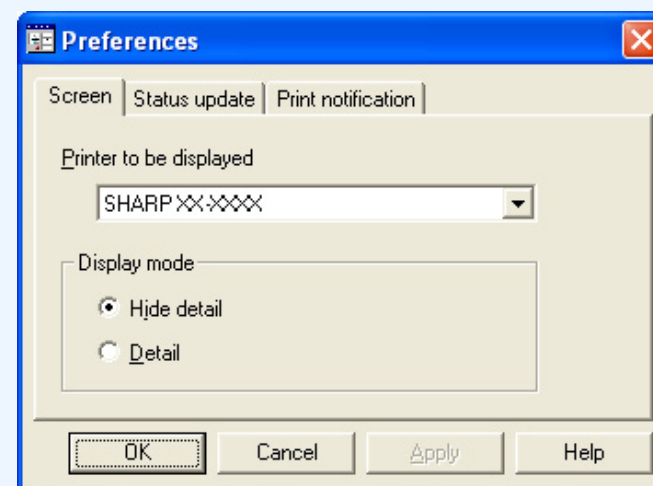

Checking the printer status

The Printer Status Monitor allows you to check whether or not toner and paper remain in the machine.

- 1 Right-click the Printer Status Monitor icon () on the task bar, and select "SHARP XX-XXXX Status" from the pop-up menu.

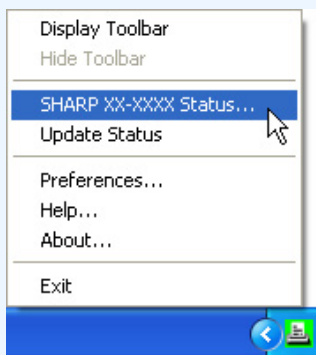

The icon turns red when printing is not possible due to a machine error or other problem.

2

Click the "Detail" button.

The window expands to show machine status details.

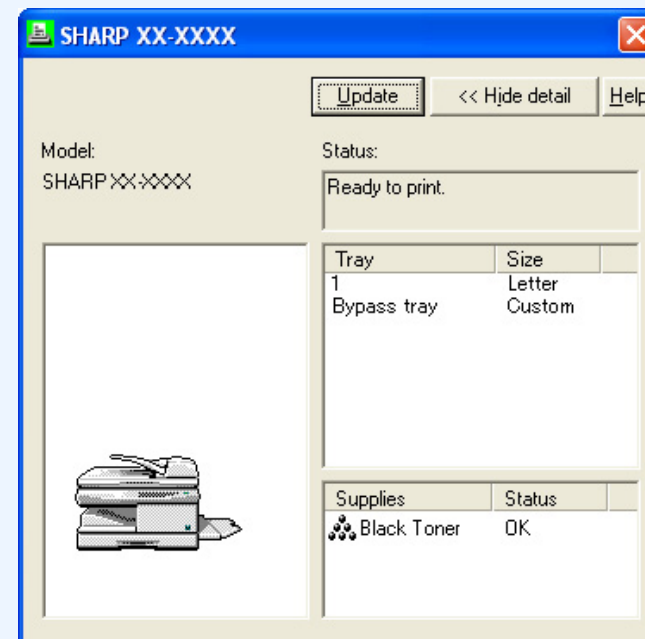
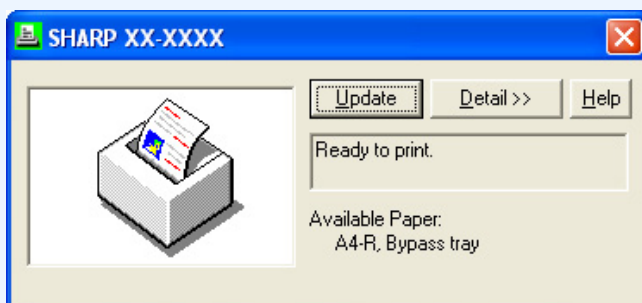

To collapse the window, click the "Hide detail" button.



By default, the collapsed window initially appears when "SHARP XX-XXXX Status" is selected in Step 1. If desired, you can change the setting to have the expanded window initially appear.

➔ [Changing the Printer Status Monitor settings](#)

To use the machine as a printer for the Macintosh, the PS3 expansion kit (AR-PK1N) must be installed and the machine must be connected to a network. To install the PPD file and configure the printer driver settings, see the software setup guide.

Before printing, make sure that the correct size of paper for your document has been loaded in the machine.

1 Start the application and open the document that you wish to print.

2 Select "Print" from the application's "File" menu.

3 Make sure that the correct printer is selected.

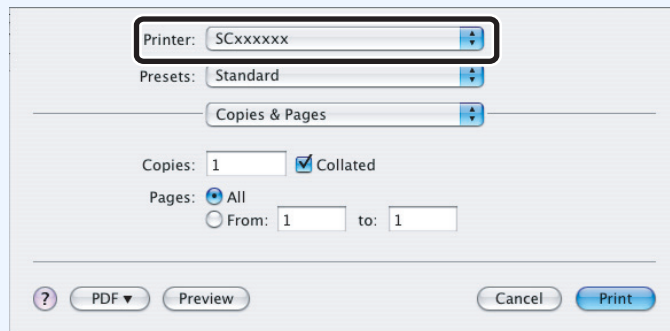

The Print window varies depending on the operating system version, the printer driver version, and the application.

4 Configure print settings.

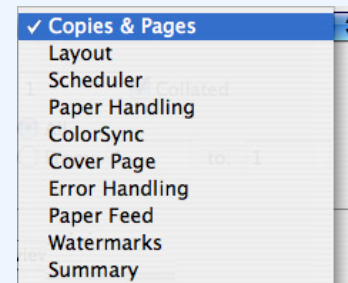

Click  next to "Copies & Pages" ("General" in Mac OS 9.0 to 9.2.2) and select the settings that you wish to configure from the pull-down menu. The corresponding setting screen will appear.



The settings vary depending on the operating system version, the printer driver version, and the application.

5 Click the "Print" button.

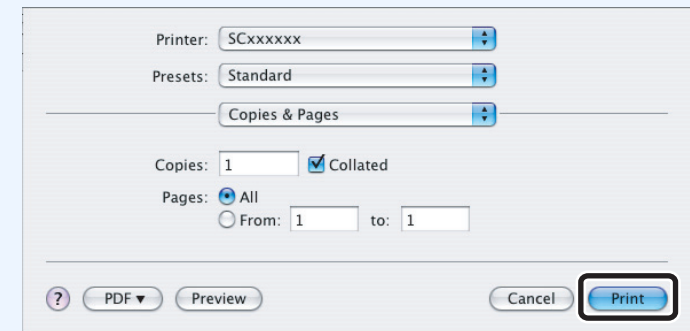

Printing begins.

If the tray runs out of paper during printing

Printing will automatically resume when paper is loaded in the tray.

When using the bypass tray, select printer mode with the mode select key on the machine, load paper as instructed by the message in the display, and then press the [START] key to resume printing.

When the 250-sheet paper feed unit is installed:

Note that if the "AUTO TRAY SWITCH" setting in the user programs is enabled and there is the same size of paper in another tray, the machine will automatically switch to the other tray and continue printing.

Cancel a print job

To cancel a print job that is already in progress, select printer mode with the mode select key on the machine and then press the [CLEAR] key (C) or the [CLEAR ALL] key (CA).

"CANCEL PRINT JOB?" will appear in the display. Select "YES" and press the [ENTER] key.

When "Paper Feed" is set to "Auto Select"

If "Paper Feed" is set to "Auto Select" in the Print window and the correct size of paper for a print job is not loaded in the machine, the printing procedure will vary depending on the "FORCED OUTPUT" setting in the user programs (see "USER PROGRAMS" in the Operation Manual).

When "FORCED OUTPUT" is set to "OFF"

Select printer mode with the mode select key on the machine, check the message in the display, load paper in the bypass tray, and then press the [START] key to begin printing.

When "FORCED OUTPUT" is set to "ON"

Printing takes place on the paper loaded in the machine, even though the paper size is different from the print image size.

The network expansion kit includes a built-in Web server. The Web server is accessed using a Web browser on your computer. The Web pages include both pages for users and pages for the administrator. In the user Web pages, users can monitor the machine, directly print a file specified on a computer, and select printer configuration settings. In the administrator Web pages, the administrator can configure the machine's e-mail settings, settings for print by e-mail, and passwords. Only the administrator is allowed to configure these settings.

How to access the Web page and view help

Use the following procedure to access the Web pages. [Help] can be clicked at the bottom of the menu frame to view information on the various function settings that can be configured remotely over the network from the machine's Web pages. For the settings of each function, see the explanations in Help.

1 Open the Web browser on your computer.

Supported browsers:

Internet Explorer 5.5 or later (Windows)

Netscape Navigator 6.0 or later

2 In the "Address" field of your Web browser, enter the IP address that has been configured in the machine.

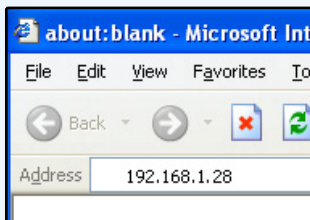

When the connection is completed, the Web page will appear in your Web browser.

👉 [About the Web pages \(for users\)](#)

3 Click the [Help] button at the bottom of the menu frame.

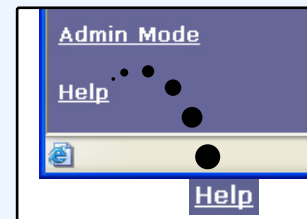

To view information on a function setting, click the corresponding item in the Help screen.

4 When finished, close the Web pages.

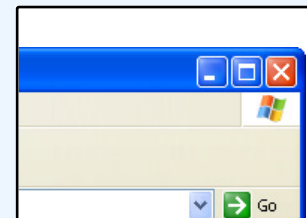

When you have finished using the Web pages, click the  (close) button in the top right corner of the page.

About the Web pages (for users)

When you access the user Web pages in the machine, the following page will appear in your browser.

A menu frame appears on the left side of the page. When you click an item in the menu, a screen appears in the right frame that allows you to configure settings for that item.

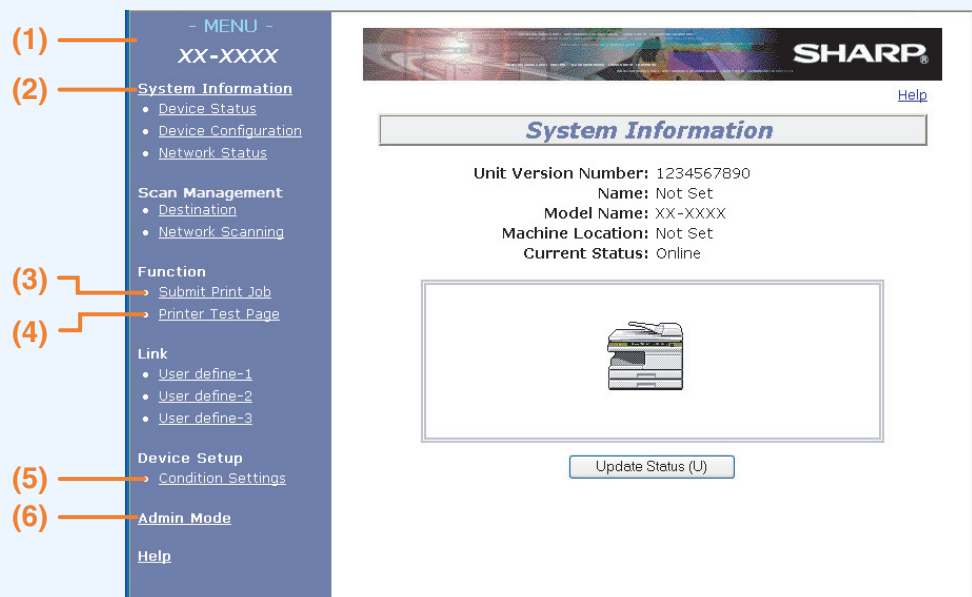

(1) Menu frame

Click a setting in the menu to configure it.

(2) System Information

Shows the current status of the machine and model name.

• Device Status

Shows the current status of the machine, paper trays, output trays, toner and other supplies, and page counts. Out of paper and other warnings appear in red.

• Device Configuration

Shows what options are installed.

• Network Status

Shows the network status. Information on "General", "TCP/IP", "NetWare", "AppleTalk", and "NetBEUI" is shown on the respective pages.

(3) Submit Print Job

A file on a computer can be printed out.

[Directly printing a file in a computer](#)

(4) Printer Test Page

The "Printer Settings List" and various font lists can be printed.

(5) Condition Settings

Configure basic printer settings.

[Configuring the printer condition settings](#)

(6) Admin Mode

To open the Web pages for the administrator, click here and then enter the administrator's user name and password.

[About the Web pages \(for the administrator\)](#)

[Protecting information programmed in the web page \(\[Passwords\]\)](#)

Directly printing a file in a computer

A file that can be accessed by your computer can be directly printed without using the printer driver by specifying the file's address. Any file that can be accessed by your computer can be printed by this method, including not only files on your computer but files on other computers connected to the same network.

To directly print a file by this method, click [Submit Print Job] in the menu frame of the Web page.

1 Click [Submit Print Job] in the link menu.

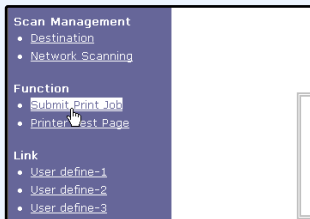

The "Submit Print Job" screen will appear.

2 Select the print format in "Job Detail". The settings are described in the table below.

 A screenshot of the 'Submit Print Job' web page. The page has a title bar 'Submit Print Job' and a 'Current Status' section showing 'Online' with an 'Update Status (U)' button. Below is the 'Job Detail' section with the following settings: 'Copies' set to 1, 'Paper Size' set to 'Not Specified', 'Orientation' set to 'Portrait', 'Binding Edge' set to 'Left', and 'Duplex' as an unchecked checkbox. There is a note: 'Files with embedded printer settings will take precedence over web page settings.' Below that, it lists supported file types: 'The machine can print following file types: PDF(V1.3)(*) with file extensions pdf, TIFF with file extensions tif.' A further note states: 'Note: (*) Available only if the PS3 expansion kit is installed. Copy protected PDF files cannot be printed.' At the bottom, there is an 'Enter Filename' field with a 'Browse...' button and a 'Print (P)' button.

3 Click [Browse] and select the file that you wish to print.

You can also directly enter the file name (with the path).

4 Click [Print].

Printing begins.

Advanced job settings

Item	Description	Factory default setting
Copies	Set the number of copies from 1 to 999.	1
Paper Size	Select the size of paper to be used for printing.	Not Specified
Orientation	Select the printing orientation. (Portrait / Landscape)	Portrait
Binding Edge	Select the binding position for two-sided printing. (Left / Top)	Left
Duplex	To print on both sides of the paper, select this checkbox. (Only for models that support the two-sided printing.)	Not selected

The printer condition settings allow basic printer settings to be configured. The following items can be set:

- [Default Settings](#): Basic settings that are mainly used when the printer driver is not used.
 - [PCL Settings](#): PCL symbol set, font, line feed code, and other settings.
 - [PostScript Settings](#)*: Sets whether or not a PostScript error page is printed when a PostScript error occurs.
- * This setting is only appears when the PS3 expansion kit is installed.



When the printer driver is used and the same settings are configured both in the printer driver and in the above screens, the settings configured in the printer driver override the settings in the above screens. If a setting is available in the printer driver, use the printer driver to configure the setting.

How to configure the settings

To display the Condition Settings screen, click [Condition Settings] in the menu frame.

For detailed explanations of the procedures for establishing settings, click [Help] in the menu frame.

(1) Condition Settings

This displays the page for configuring the printer condition settings.

(2) Default / PCL / PS

Select the type of condition settings that you wish to configure.

(3) Settings

The factory default settings are displayed.

Change the settings as desired by selecting from drop-down lists and by directly entering settings.

For information on the settings, see "[Printer condition settings](#)".

(4) Submit

Click to store the Web page settings in the machine.

Printer condition setting menu

Click on a setting to view an explanation of the setting.

Condition Settings	
Default Settings	Factory default settings
Copies	1
Orientation	Portrait
Default Paper Size	Letter
Default Paper Source	Auto
2-Sided Print	1-Sided
ROPM (Rip Once, Print Many)	Enable

Condition Settings	
PCL Settings	Factory default settings
Symbol Set	PC-8
Font	0: Courier (internal font)
Line Feed Code	CR=CR; LF=LF; FF=FF
Wide A4	Disable
PostScript Settings*	Factory default settings
Print PS Errors	Disable

* This setting is only appears when the PS3 expansion kit is installed.

Printer condition settings

Factory default settings are indicated in bold.

Default Settings

Item	Selections	Description
Copies	1 - 999	This is used to select the number of copies.
Orientation	Portrait , Landscape	This sets the orientation of the printed page. Select [Portrait] when the image is longer in the vertical direction, or [Landscape] when the image is longer in the horizontal direction.
Default Paper Size	Invoice, Letter , Foolscap, Legal	This sets the default paper size used for the printed image. Even if the set size of paper is not in any of the trays, the printed image is formed in accordance with this setting.
Default Paper Source	Auto , Tray 1, Tray 2*, Bypass (Auto)	Set the default paper tray. *Selections available depend on the trays that are installed.
2-Sided Print	1-Sided , 2-Sided (Book), 2-Sided (Tablet)	When [2-Sided (Book)] is selected, two-sided printing takes place so as to allow binding at the left side. When [2-Sided (Tablet)] is selected, two-sided printing takes place so as to allow binding at the top. (Only for models that support two-sided printing.)
ROP (Rip Once, Print Many)	Enable , Disable	This enables the ROPM function. When enabled, multi-page print jobs are stored in memory before printing, and thus the computer does not need to repeatedly send the print data when multiple copies are printed.

PCL Settings

Item	Selections	Description
Symbol Set	Select one of 35 sets.	This specifies which country's characters (PCL symbol set) are assigned to certain of the symbols in the character code list. The factory default setting is [PC-8].
Font	Select one internal or one external font.	This specifies which PCL font to use for printing. One font can be specified from among the internal fonts and extended fonts (when the barcode font kit or the Flash ROM kit is installed). The factory default setting is [0: Courier].
Line Feed Code	CR=CR; LF=LF; FF=FF, CR=CR+LF; LF=LF; FF=FF, CR=CR; LF=CR+LF; FF=CR+FF, CR=CR+LF; LF=CR+LF; FF=CR+FF	This specifies the line break code by means of a combination of the "CR" (return) code, "LF" (line break) code, and "FF" (page break) code. The factory default setting is printing based on the transmitted code. The setting can be changed by selecting one of four combinations.
Wide A4	Enable, Disable	This setting can be enabled to print 80 lines on A4 size paper with each line 10CPI font (English characters). When the setting is disabled (a checkmark does not appear), each line is 78 characters long.

PostScript Settings

The "PostScript Settings" are only effective when the PS3 expansion kit is installed.

Item	Selections	Description
Print PS Errors	Enable, Disable	When this setting is enabled, an error description is printed each time a PostScript error occurs.

About the Web pages (for the administrator)

In addition to the menus that appear for users, other menus that can only be used by the administrator appear in the administrator Web pages. A menu frame appears on the left side of the page. When you click an item in the menu, a screen appears in the right frame that allows you to configure settings for that item. Settings that can only be configured by the administrator are explained here.

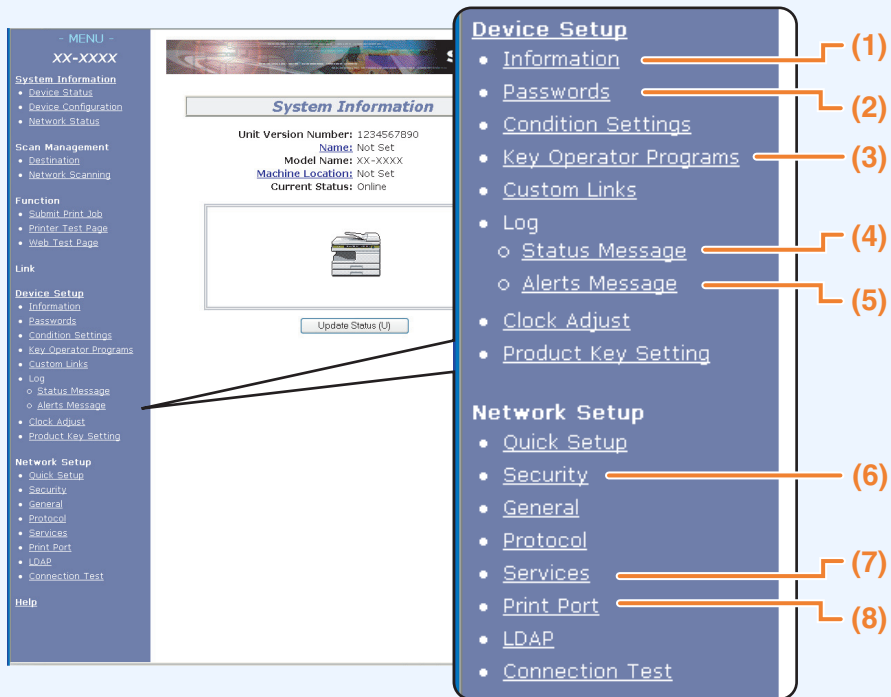

(1) Information

Configure machine identification information for the status & alert E-mail function.

☞ [Information setup](#)

(2) Passwords

To protect the Web site, the system administrator can establish passwords. Enter a password that you would like to establish and click the [Submit] button.

One password can be established for the administrator and one password can be established for users.

☞ [Protecting information programmed in the web page \(\[Passwords\]\)](#)

(3) Key Operator Programs

Setting changes can be prohibited and interface settings can be configured.

☞ [Key operator programs](#)

(4) Status Message

Configure parameters required for sending status messages, such as destination addresses and time schedules.

☞ [Status message setup](#)

(5) Alerts Message

Store destination addresses for alert messages.

☞ [Alerts message setup](#)

(6) Security

Unused ports can be disabled for greater security and port numbers can be changed.

(7) Services

Configure information concerning the e-mail system.

☞ [SMTP setup](#)

(8) Print Port

Configure settings for e-mail print.

☞ [Setting up the E-mail print function](#)

Protecting information programmed in the web page ([Passwords])

Passwords can be set (click [Passwords] in the menu frame) to restrict Web page access and protect settings. The administrator must change the password from the factory default setting. The administrator must also take care to remember the new password. The next time the Web pages are accessed, the new password must be entered. A password can be set for the administrator and a password can be set for users.

1 Click [Passwords] in the menu frame.

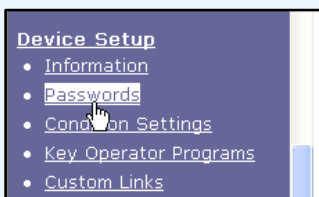

2 Enter the current password in "Admin Password".

When establishing a password for the first time, enter "Sharp" in "Admin Password".



Be sure to enter "S" in upper case and "harp" in lower case (passwords are case sensitive).

3 Enter passwords in "User Password" and "Admin Password".

- A maximum of 7 characters and/or numbers can be entered for each password (passwords are case sensitive).
- Be sure to enter the same password in "Confirm Password" as you did in "New Password".

4 When you have finished entering all items, click [Submit].

The entered password is stored.

After setting the password, turn the machine power off and then back on.



When prompted to enter a password, a user should enter "user" and an administrator should enter "admin" in "User Name". In "Password", the respective password for the entered user name should be entered. For more information, click [Help] in the upper right-hand corner of the window.

An e-mail account can be set up for the machine. When this is done, the machine will periodically check the e-mail server for e-mail and automatically print out any file attachments it receives. This provides a means for printing a file from a computer that does not have the printer driver installed, as the user can simply send the file to the machine as an e-mail attachment.

Setting up the E-mail print function

To use the e-mail print function, the machine must have an e-mail account.

1 Click [Print Port] in the menu frame.

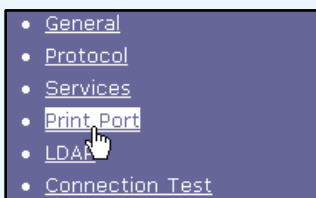

The "Print Port Setup" page appears.

3 Enter the information regarding the e-mail environment.

For detailed information, Click [Help] in the upper right-hand corner of the window.

4 Click [Submit] to store the entered information.

2 Click [E-mail print].

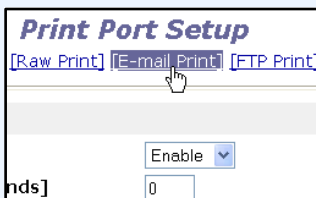

Using the E-mail print function

To use the e-mail print function, attach the file that you wish to print to an e-mail message and send the e-mail to the machine's e-mail address.

The machine can print the following file types:

PCLXL, PCL5e, PS, PDF, and TIFF, with file extensions pcl, ps, pdf, tiff, and tif

Control commands can be entered in the message of the e-mail to specify the number of copies and print format. Commands are entered in the format "command name = value".

The following control commands can be entered:

Function	Command name	Value	Entry example
Copies	COPIES	1-999	COPIES=2
Two-sided print	DUPLEX	OFF, TOP, LEFT	DUPLEX=LEFT
File type	LANGUAGE	AUTO, PCL, PCLXL, POSTSCRIPT, PDF, TIFF	LANGUAGE=TIFF
Paper	PAPER	Name of available paper (LETTER, etc.)	PAPER=A4



- Enter the commands in Plain Text format. If entered in Rich Text format (HTML), the commands will have no effect.
- To receive a list of the control commands, enter the command "Config" in the e-mail message.
- If an e-mail is sent with nothing entered in the message, printing will take place according to the settings in the condition settings menu in the Web page "[Default Settings](#)".
- To print PS and PDF files, the PS3 expansion kit is required.
- An encrypted PDF file cannot be printed.
- Only enter a "File type" when you are specifying a page-description language. Normally there is no need to enter a file type.

The key operator programs are used to prohibit changes to the [Condition Settings] and to configure interface settings.

- [Default Settings](#): Select the setting for which you wish to prohibit changes.
- [Interface settings](#): Enable monitoring of data sent to the network port and set restrictions.

Configuring a setting in the key operator programs

- 1** Click [Key operator programs] in the menu frame.

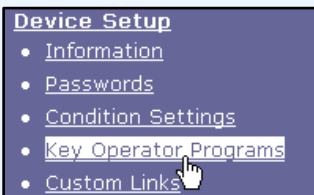

The "Default Settings" screen of the [Key operator programs] will appear. If you wish to select a setting in the "Default Settings" screen, go to step 3.

- 3** Make a selection for the setting in the screen that appears.

See [Key operator programs](#) for descriptions of the settings.

- 4** Click [Submit] to store the entered information.

- 2** Click the desired setting.

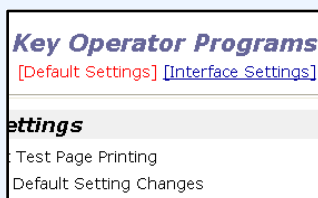

Key operator programs

When "YES, NO" appears in the "Settings" column, "YES" is selected when a checkmark appears in the checkbox of the item, and "NO" is selected when checkmark does not appear.

Default settings

Item	Settings	Description
Prohibit Test Page Printing	YES, NO	This setting is used to prohibit printing of a printer test page.
Disable Default Setting Changes	YES, NO	This setting is used to prohibit changes to the default condition settings.
Disabling of Clock Adjustment	YES, NO	This setting is used to prohibit changes to the date and time settings. This item does not appear when the fax option is installed.

Interface settings

Item	Settings	Description
Hexadecimal Dump Mode	YES, NO	This program is used to print out the print data from the computer in hexadecimal and in the corresponding text characters (based on ASCII code). This allows you to check whether or not print data is being correctly sent from the computer.
I/O Timeout	1- 60 - 999 (sec)	During reception of a print job, if remaining data is not received after the time set here elapses, the port connection is broken and the next print job is begun.
Emulation Switching	Auto* , PostScript*, PCL	Select the printer language. When [Auto] is selected, the language is automatically selected from the data sent to the printer. Unless errors occur frequently, do not change the setting from [Auto] to another setting. *Only when the PS3 expansion kit is installed.
Port Switching Method	Switch at End of Job , Switch after I/O Timeout	Select the method for switching network ports.

These functions send information on machine use (print count, copy count, etc.) and error conditions (paper misfeed, out of paper, out of toner, etc.) via e-mail to the administrator of the machine or the dealer.

Information setup

Machine identification information for the status and alert e-mail functions is configured in the "Information Setup" screen. The entered information will be included in status and alert e-mail messages.

- 1 Click **[Information]** in the menu frame.

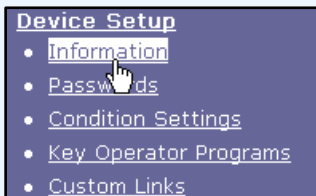

The "Information Setup" screen will appear.

- 2 Enter the machine information.

For detailed information, click the [Help] button in the upper right-hand corner of the window.

- 3 Click **[Submit]** to store the entered information.

SMTP setup

The Status and alert e-mail functions use SMTP (Simple Mail Transport Protocol) to send e-mail. The following procedure is used to set up the e-mail environment. This must be done by the system administrator or other person familiar with the network.

- 1 Click **[Services]** in the menu frame.
The "Services Setup" screen will appear.

- 2 Click **[SMTP]**.

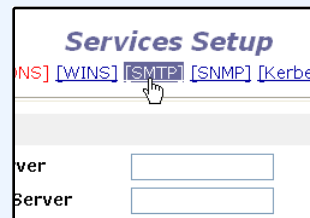

- 3 Enter the information required to set up the e-mail environment.

For detailed information, click the [Help] button in the upper right-hand corner of the window.

- 4 Click **[Submit]** to store the entered information.

Status message setup

Use the status message function to send the current counter information, including the copy count, print count, and total output count, basis on the specified schedule. The destinations can be set for administrators and dealers respectively.

To set up the status message, follow these steps.

1 Click [Status Message] in the menu frame.



The "Status Message Setup" screen will appear.

2 Enter the required information, including the destination addresses and time schedule.

For detailed information, click the [Help] button in the upper right-hand corner of the window.

 A screenshot of the "Status Message Setup" web form. At the top, it says "Status Message Setup" with links for "[Standard]" and "[Advanced]". Below that is a section titled "E-mail Status Message List 1" containing an "E-mail Address" input field, two checkboxes for "Send by Schedule 1" and "Send by Schedule 2", and a "Send Now (1)" button.

3 Click [Submit] to store the entered information.

When the E-mail Status settings are completed, printer count information will be sent periodically by e-mail to the specified e-mail addresses.



If you quit the browser before clicking [Submit], the settings will be canceled. To send printer information immediately to the specified e-mail addresses, click [Send Now].

Alerts message setup

Use the alert message function to send alert information, such as empty toner and paper and trouble including paper misfeeds, to specified destinations when such problems occur. The destinations can be set for administrators and dealers respectively.

To set up the alert message, follow the procedure below.

1 Click [Alerts Message] in the menu frame.



The "Alerts Message Setup" screen will appear.

2 Enter the destination addresses.

For detailed information, click the [Help] button in the upper right-hand corner of the window.

 A screenshot of the "Alerts Message Setup" screen. It has a title bar with "Alerts Message Setup" and a "Help" button. Below the title bar, there are two sections: "E-mail Alert Message List 1" and "E-mail Alert Message List 2". Each section has an "E-mail Address" label and an empty text input field.

3 Click [Submit] to store the entered information.

If these parameters are set, event information for the printer will be transmitted to the specified addresses via E-mail each time a specified event occurs. The meaning of each event item is shown below.

(Example)

Paper Jam: A paper misfeed has occurred.

Toner Low: Toner is low.

Toner Empty: Toner must be added.

Paper Empty: Paper must be loaded.



If you quit the browser before clicking [Submit], the settings will be canceled.

This chapter explains how to solve network connection problems. For information on paper, removing misfeeds, and replacing the toner cartridge, see the operation manual for the machine.

Check the connections

■ Is the LAN cable disconnected?

Make sure that the LAN cable is firmly inserted in the connectors on the network expansion kit and your computer. For information on connecting the LAN cable, see software setup guide for network printer.

■ Is the machine configured for use on the same network as the computer?

The machine cannot be used if it is not connected to the same network as the computer, or if it is not configured for use on the network.

For more information, consult your network administrator.

Points to check in Windows

■ Are you using a port that was created with Standard TCP/IP Port?

If you are using a port created using Standard TCP/IP Port in Windows 2000/XP/Server 2003/Vista, printing may not take place correctly if "SNMP Status Enabled" is selected in the port settings of the printer driver. Open the printer driver properties and click the "Configure Port" button on the "Ports" tab. In the window that appears, make sure the "SNMP Status Enabled" checkbox is not selected .

Points to check on the Macintosh

■ Is AppleTalk enabled?

In Mac OS X, click "Network" in "System Preferences" and select Ethernet in "Show". Click the "AppleTalk" tab and make sure that "Make AppleTalk Active" is selected.

In Mac OS 9.0 to 9.2.2, open the "Chooser" from the Apple menu and make sure that "Active" is selected. Printing is not possible if "Active" is not selected.

■ Is "Ethernet" selected for the "Connect via" of AppleTalk? (When using Mac OS 9.0 to 9.2.2.)

Open "AppleTalk" from the "Control Panels" and make sure that "Ethernet" is selected in the "Connect via" menu. Printing is not possible if "Ethernet" is not selected.

Removing the software

In the event that you need to remove the printer driver or utilities, follow these steps:

Windows

- 1** Click the "start" button, and then click "Control Panel".

On Windows 98/Me/2000, click the "Start" button, select "Settings", and then click "Control Panel".

- 2** Click "Add or Remove Programs".

- On Windows Vista, click the "Uninstall a program".
- On Windows 98/Me/2000, double-click the "Add/Remove Programs" icon.

- 3** Select the driver or utility that you wish to remove from the list, and click the appropriate button to remove it.

For more information, refer to your operating manual or to the help files for your operating system.

- 4** Restart your computer.

 When reinstalling the software, install it correctly as explained in software setup guide for the network expansion kit.

Macintosh (Mac OS 9.0 to 9.2.2)

- 1** Insert the "Software CD-ROM" (Disc 2) into your CD-ROM drive.

- 2** Double-click the CD-ROM icon () on the desktop and double-click the "Mac OS" folder.

- 3** Double-click the "Installer" icon ().

- 4** Select "Remove" from the Install menu and then click the "Remove" button.



There is no remove tool for Mac OS X. The PPD file for Mac OS X has been copied to the following folder in the startup disk:

[Library] - [Printers] - [PPDs] - [Contents] - [Resources] - [En.lproj] folder

Printer specifications

Printing speed	Max. 20 ppm (when printing on letter size paper)
Resolution	600 dpi / 300 dpi*1
Network expansion kit memory*2	Standard memory: 64 MB Additional memory slot: 1 slot (a 128 MB or 256 MB of additional memory module (144-pin SDRAM SODIMM) can be installed)
Emulation	PCL5e, PCL6, PS3 (PostScript 3)*3
Installed fonts	PCL6/PCL5e compatible: 80 outline fonts and 1 bitmap font PostScript 3 compatible*3: 136 outline fonts
Interface	10Base-T/100Base-TX Ethernet

*1 300 dpi can only be selected when using the PCL6 or PCL5e printer driver.

*2 For information on machine memory, see the manual for the machine.

*3 Available only if the PS3 expansion kit (AR-PK1N) is installed.



As a part of our policy of continuous improvement, SHARP reserves the right to make design and specification changes for product improvement without prior notice. The performance specification figures indicated are nominal values of production units. There may be some deviations from these values in individual units.

Function		PCL6	PCL5e	PS	Windows PPD	Macintosh PPD	
Frequently used functions	Number of copies	1 to 999	1 to 999	1 to 999	1 to 999	1 to 999	
	Printing orientation	Yes	Yes	Yes	Yes	Yes	
	Two-sided printing	Yes	Yes	Yes	Yes	Yes	
	Binding Style	Book/Tablet	Book/Tablet	Book/Tablet	Long Side / Short Side	Long Side / Short Side	
	Pamphlet Style	Yes	Yes	Yes	No ^{*1}	No	
	N-up	Number	2, 4, 6, 8, 16	2, 4, 6, 8, 16	2, 4, 6, 8, 16	2, 4	2, 4, 6, 9, 16
		Order	Selectable	Fixed	Selectable	Fixed	Selectable
Border		Yes/No	Yes/No	Yes/No	Yes/No	Selectable	
Paper	Paper Size	Yes	Yes	Yes	Yes	Yes	
	Custom Paper Size	1 size	1 size	1 size	3 sizes	1 size ^{*2}	
	Source Selection	Yes	Yes	Yes	Yes	Yes	
	Cover Settings	Yes	Yes	Yes	No	Yes	

(continued)

*1 Pamphlet style printing is available in Windows 2000/XP/Server 2003/Vista.

*2 Cannot be used in Mac OS X v10.1.5.

Function		PCL6	PCL5e	PS	Windows PPD	Macintosh PPD
Graphics	Resolution	600/300dpi	600/300dpi	600dpi	600dpi	600dpi
	Halftone	No	No	Yes	No	No
	Graphics Mode	Yes	Yes	No	No	No
	Zoom	No	No	Yes	Yes	Yes
	Mirror Image	No	No	Yes	Yes	Yes ^{*3}
	Negative Image	No	No	Yes	Yes	Yes ^{*3}
	Fit to Page	Yes	Yes	Yes	No	Yes ^{*4}
Fonts	Resident fonts	80 fonts	80 fonts	136 fonts	136 fonts	35 fonts
	Selectable download fonts	bitmap, TrueType, Graphics	bitmap, TrueType, Graphics	bitmap, Type 1, TrueType	bitmap, Type 1, TrueType	No ^{*5}

(continued)

*3 Cannot be used in Mac OS X.

*4 Can only be used in Mac OS X v10.4.

*5 Type 1 and TrueType can be selected in some versions of LaserWriter.

Function		PCL6	PCL5e	PS	Windows PPD	Macintosh PPD
Other functions	Auto configuration Settings	Yes	Yes	Yes	No	Yes ^{*3}
	ROPM	Yes	Yes	Yes	Yes	Yes
	Overlay	Yes	Yes	Yes	No	No
	Watermark	Yes	Yes	Yes	Yes	Yes
	Job Compression	No	No	Yes	No	No
	Bitmap Compression	No	No	Yes	No	No

*3 Cannot be used in Mac OS X.

Numerics

"2-Up Pamphlet" 11

A

About the Web pages

For users 24

For the administrator 32

Accessing Web pages 23

Alerts message setup 40

B

Basic printing

Macintosh 21

Windows 6

"Border" 12

C

Cancel a print job

Macintosh 22

Windows 7

Check the connections 41

Condition settings 28

Configuring the printer condition settings 28

D

Default Settings 29

Directly printing a file in a computer 25

"Document Style" 10

E

E-mail print function 34

F

"Fit to Page" 13

H

"Help" button 9

How to configure the settings 27

How to use the online manual 3

I

"Image Orientation" 14

Information setup 38

Introduction 2

K

Key operator programs 36

N

"N-Up Printing" 12

O

Opening the printer driver 8

"Order" 12

P

Pamphlet style 11

Passwords 33

PCL Settings 30

Points to check on the Macintosh 41

PostScript Settings 31

[Print Port] 34

Printer Administration Utility 17

Printer condition settings 29

Printer driver settings 9

Printer driver specifications 44

Printer specifications 43

Printer Status Monitor 17

PRINTER UTILITIES 17

Printing a watermark 15

PRINTING FROM MACINTOSH 21

PRINTING FROM WINDOWS 6

R

Removing the software 42

"Rotate 180 degrees" 14

S

Settings 9

SMTP setup 38

SPECIFICATIONS 43

Status message setup 39

[Submit Print Job] 25

T

Text To Black 16

"Tiled Pamphlet" 11

Troubleshooting 41

V

Vector To Black 16

W

"Watermark" 15

WEB FUNCTIONS IN THE MACHINE 23

SHARP[®]

SHARP CORPORATION